



# VGA & Audio to HDMI Scaler/Converter

EXT-VGAA-HD-SC

User Manual



Release A1

# Important Safety Instructions

1. Read these instructions.
2. Keep these instructions.
3. Heed all warnings.
4. Follow all instructions.
5. Do not use this product near water.
6. Clean only with a dry cloth.
7. Do not block any ventilation openings. Install in accordance with the manufacturer's instructions.
8. Do not install or place this product near any heat sources such as radiators, heat registers, stoves, or other apparatus (including amplifiers) that produce heat.
9. Do not defeat the safety purpose of the polarized or grounding-type plug. A polarized plug has two blades with one wider than the other. A grounding type plug has two blades and a third grounding prong. The wide blade or the third prong are provided for your safety. If the provided plug does not fit into your outlet, consult an electrician for replacement of the obsolete outlet.
10. Protect the power cord from being walked on or pinched particularly at plugs, convenience receptacles, and the point where they exit from the apparatus.
11. Only use attachments/accessories specified by the manufacturer.
12. To reduce the risk of electric shock and/or damage to this product, never handle or touch this unit or power cord if your hands are wet or damp. Do not expose this product to rain or moisture.
13. Unplug this apparatus during lightning storms or when unused for long periods of time.
14. Refer all servicing to qualified service personnel. Servicing is required when the apparatus has been damaged in any way, such as power-supply cord or plug is damaged, liquid has been spilled or objects have fallen into the apparatus, the apparatus has been exposed to rain or moisture, does not operate normally, or has been dropped.
15. Batteries that may be included with this product and/or accessories should never be exposed to open flame or excessive heat. Always dispose of used batteries according to the instructions.

# Warranty Information

Gefen warrants the equipment it manufactures to be free from defects in material and workmanship.

If equipment fails because of such defects and Gefen is notified within two (2) years from the date of shipment, Gefen will, at its option, repair or replace the equipment, provided that the equipment has not been subjected to mechanical, electrical, or other abuse or modifications. Equipment that fails under conditions other than those covered will be repaired at the current price of parts and labor in effect at the time of repair. Such repairs are warranted for ninety (90) days from the day of reshipment to the Buyer.

This warranty is in lieu of all other warranties expressed or implied, including without limitation, any implied warranty or merchantability or fitness for any particular purpose, all of which are expressly disclaimed.

1. Proof of sale may be required in order to claim warranty.
2. Customers outside the US are responsible for shipping charges to and from Gefen.
3. Copper cables are limited to a 30 day warranty and cables must be in their original condition.

The information in this manual has been carefully checked and is believed to be accurate. However, Gefen assumes no responsibility for any inaccuracies that may be contained in this manual. In no event will Gefen be liable for direct, indirect, special, incidental, or consequential damages resulting from any defect or omission in this manual, even if advised of the possibility of such damages. The technical information contained herein regarding the features and specifications is subject to change without notice.

For the latest warranty coverage information, refer to the Warranty and Return Policy under the Support section of the Gefen Web site at [www.gefen.com](http://www.gefen.com).

## Technical Support

(818) 772-9100      (800) 545-6900  
8:00 AM to 5:00 PM Monday - Friday, Pacific Time

## Fax

(818) 772-9120

## Email

support@gefen.com

## Web

<http://www.gefen.com>

## Mailing Address

Gefen, LLC  
c/o Customer Service  
20600 Nordhoff St.  
Chatsworth, CA 91311

## Product Registration

Register your product here: <http://www.gefen.com/kvm/Registry/Registration.jsp>

# Operating Notes

- Audio from the 2-channel analog input will be automatically embedded into the HDMI output signal.
- By default, the current input and output resolution will be displayed whenever the VGA & Audio to HDMI Scaler/Converter is disconnected from the source or display or if a change in the video output settings are made. This feature can be disabled through the Display Notify option. See [Display Notify \(page 37\)](#) and the `#set_display_notify` command for more information.
- When specifying a preset within the included set of command, the preset value will always be displayed as one greater than the original value. See [Using Preset Values \(page 52\)](#) for more information.
- Always make sure that the VGA & Audio to HDMI Scaler/Converter is running the latest firmware. The Gefen Syner-G Software Suite is a free downloadable application from Gefen that provides automatic download and installation of firmware upgrades for this product.

Download the application here: <http://www.gefen.com/support/download.jsp>

**VGA & Audio to HDMI Scaler/Converter** is a trademark of Gefen, LLC.

© 2014 Gefen, LLC. All Rights Reserved. All trademarks are the property of their respective owners.

Gefen, LLC reserves the right to make changes in the hardware, packaging, and any accompanying documentation without prior written notice.



This product uses UL or CE listed power supplies.

## Features

- Converts and scales VGA and L/R analog audio to HDMI
- Input resolutions up to 1920 x 1200 (WUXGA)
- Output resolutions up to 1080p60 and 1920 x 1200 (WUXGA)
- On-screen display (OSD) menu allows easy set-up and control
- Aspect Ratio Control: Full Screen, Panoramic, Letter/Pillar, Extract/Crop
- Test Pattern Generator for quick system configuration
- Embeds 2-channel analog stereo audio in HDMI signal
- Gefen Syner-G™ simplifies in-field firmware updates and advanced EDID management including custom input timings
- USB port for use with Gefen Syner-G™
- Wide power supply operating range (6V to 24V DC)
- Locking power supply connector
- Surface mountable

## Packing List

The VGA & Audio to HDMI Scaler/Converter ships with the items listed below. If any of these items are not present in the box when you first open it, immediately contact your dealer or Gefen.

- 1 x VGA & Audio to HDMI Scaler/Converter
- 1 x 6 ft. VGA cable (M-M)
- 1 x 6 ft. 3.5mm mini-stereo cable
- 1 x 12V Power Supply
- 1 x Quick-Start Guide





## 1 Getting Started

Introduction.....	2
Installation .....	4
Connection Instructions.....	4
Sample Wiring Diagram .....	4

## 2 Basic Operation

Menu System .....	8
Displaying the Menu System.....	8
Moving around within the Menu System .....	9
Output Resolution .....	12
Output Color.....	14
Output Mode .....	16
Contrast.....	18
Brightness .....	19
Saturation.....	20
Hue.....	21
Color Range .....	22
Color Temperature .....	23
Color Balance.....	24
Edge Enhance.....	25
Sharpness .....	26
Underscan/Overscan .....	27
Aspect Ratio.....	28
Horizontal Mirror.....	29
Vertical Mirror .....	31
Horizontal Shift.....	33
Vertical Shift .....	34
Phase .....	35
OSD Timeout .....	36
Display Notify .....	37
Input Resolution Information .....	39
F/W Version .....	40
Factory Reset.....	41
Test Patterns.....	42
DIP Switch Configuration .....	44



### 3 Advanced Operation

USB Interface .....	48
Installing the Virtual COM Port .....	48
Commands .....	50
Using Preset Values .....	52

### 4 Appendix

Menu System Summary .....	126
Default Settings .....	132
Surface Mounting Instructions .....	133
Specifications .....	134
Index .....	135



# VGA & Audio to HDMI Scaler/Converter

## 1

## Getting Started

Introduction.....	2
Installation .....	4
Connection Instructions.....	4
Sample Wiring Diagram .....	4

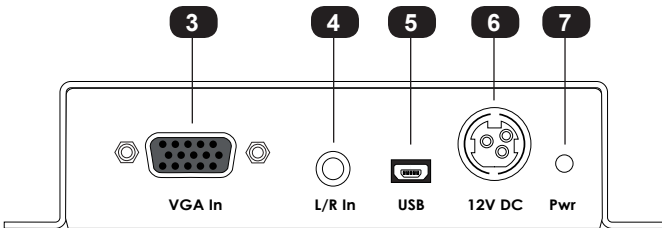
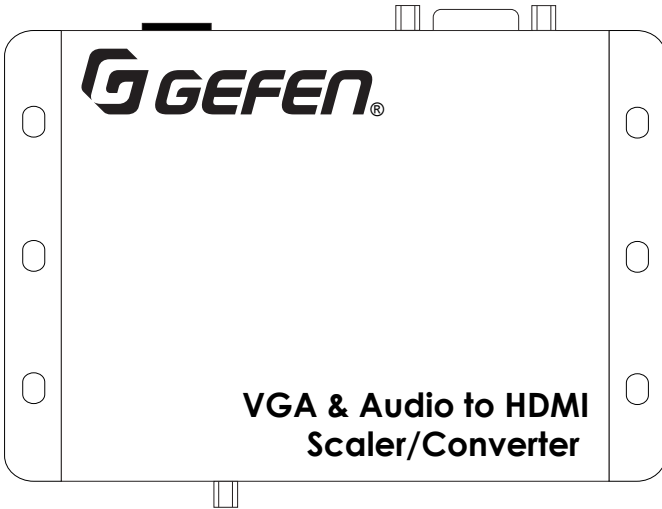
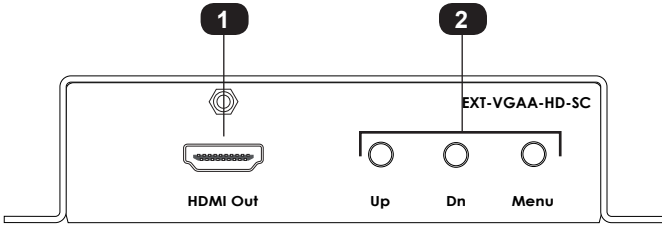

ID	Name	Description
1	HDMI Out	Use an HDMI cable to connect a Hi-Def display to this HDMI port.
2	Up, Dn, Menu	These push-buttons are used to change settings within the on-screen menu system. See <a href="#">Menu System (page 8)</a> for more information.
3	VGA In	Connect the included VGA cable from source device (e.g. computer) to this port.
4	L/R In	Connect the included 3.5mm mini-stereo cable from this port to the audio output port on the audio source device.
5	USB	This mini-USB port is used for upgrading the firmware.
6	12V DC	Connect the included 12V DC power supply to this power receptacle.
7	Pwr	Under normal operating conditions, this LED indicator will glow bright blue.

## Connection Instructions

### ▶ Video

1. Connect the included VGA cable from the video source (e.g. computer) to the **VGA In** port on the VGA & Audio to HDMI Scaler/Converter.
2. Connect an HDMI cable from the **HDMI Out** port to an HD display.

### ▶ Audio

3. Connect the included 3.5mm mini-stereo cable from the audio source to the **L/R In** port on the VGA & Audio to HDMI Scaler/Converter.

### ▶ Power

4. Connect the included power supply to the 12V DC power receptacle and connect the power cord to an available electrical outlet.

## Sample Wiring Diagram

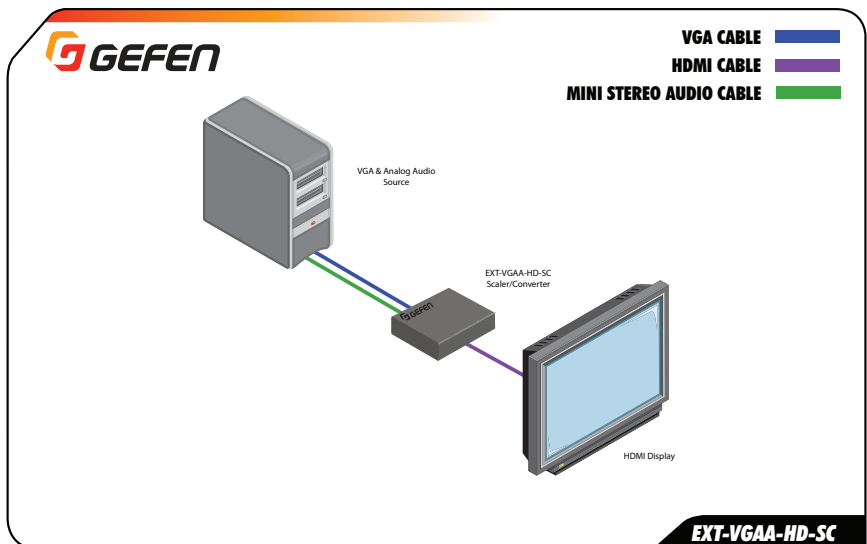







# VGA & Audio to HDMI Scaler/Converter

## 2

## Basic Operation

Menu System .....	8
Displaying the Menu System.....	8
Moving around within the Menu System .....	9
Output Resolution .....	12
Output Color.....	14
Output Mode .....	16
Contrast.....	18
Brightness .....	19
Saturation.....	20
Hue.....	21
Color Range .....	22
Color Temperature .....	23
Color Balance.....	24
Edge Enhance.....	25
Sharpness .....	26
Underscan/Overscan .....	27
Aspect Ratio.....	28
Horizontal Mirror.....	29
Vertical Mirror.....	31
Horizontal Shift.....	33
Vertical Shift.....	34
Phase.....	35
OSD Timeout .....	36
Display Notify .....	37
Input Resolution Information .....	39
F/W Version .....	40
Factory Reset.....	41
Test Patterns.....	42
DIP Switch Configuration .....	44

## Displaying the Menu System

The VGA & Audio to HDMI Scaler/Converter uses a built-in menu system to manage and control all video features.

1. To display the menu system, press the **Menu** button on the front panel.

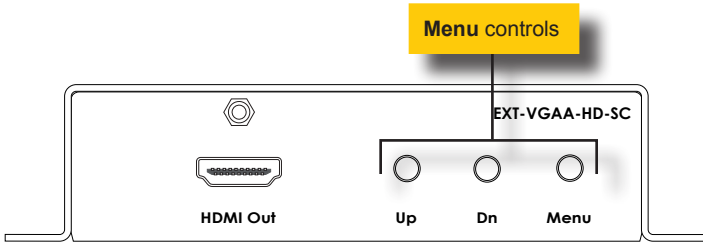

2. The menu system will be displayed in the upper-left corner of the screen, as shown below:

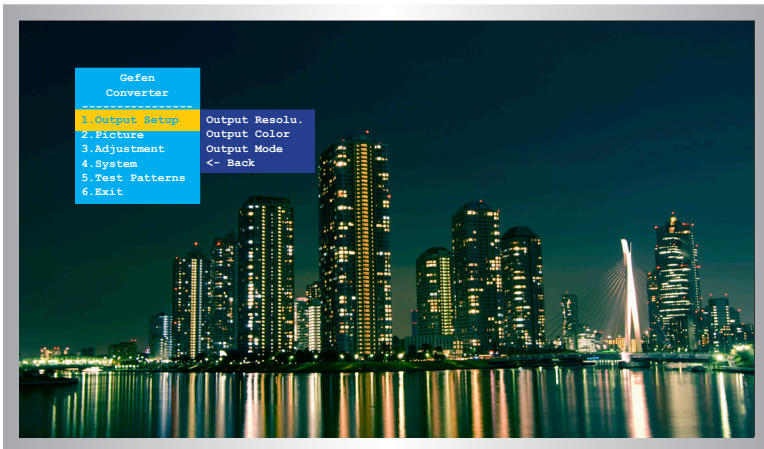

If the menu system is not used within the time interval specified by the OSD Timeout setting, then the menu system will automatically be hidden. By default, the OSD Timeout setting is 5 seconds. See [OSD Timeout \(page 36\)](#) for instructions on setting the OSD Timeout value.

(continued on next page)

## Moving around within the Menu System

1. There are six menu items within the *main menu*: **Output Setup**, **Picture**, **Adjustment**, **System**, **Test Patterns**, and **Exit**.
2. The currently selected item within the main menu will always be highlighted in yellow.
3. Each item within the main menu, with the exception of **Exit**, contains a *submenu*. The submenu, for each item in the main menu, is displayed automatically.

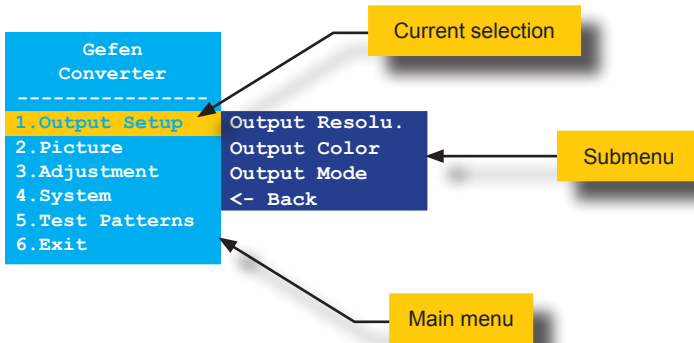

4. Use the **Up** or **Dn** button to highlight the desired item within the main menu.

For example, if we press the **Dn** button three times, the **System** menu item will be highlighted and its submenu will be displayed.

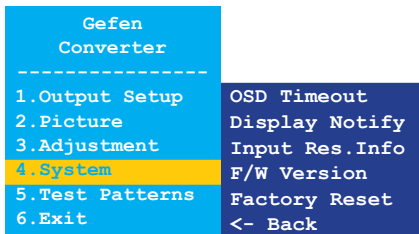

(continued on next page)

- To access the submenu for the highlighted item within the main menu, press the **Menu** button a second time. When a submenu is activated, a green bar is used to indicate the current selection. By default, the top submenu item will always be highlighted once a submenu is activated.

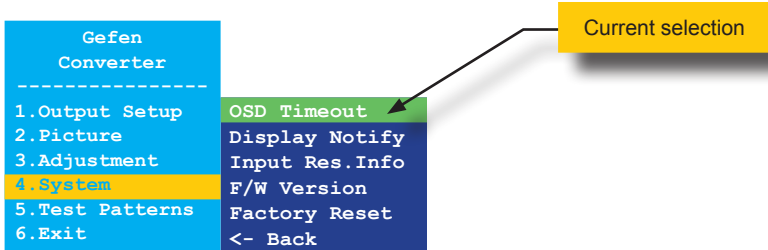

- Use the **Up** or **Dn** button to select the desired option within the submenu.

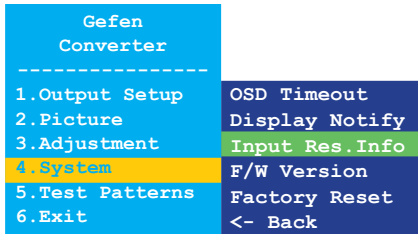

- To select the highlighted submenu item, press the **Menu** button.

For example, if we press the **Menu** button when the **Input Res. Info** option is highlighted, the menu system will be hidden and the following will be displayed:



- Press the **Menu** button to return to the menu system.

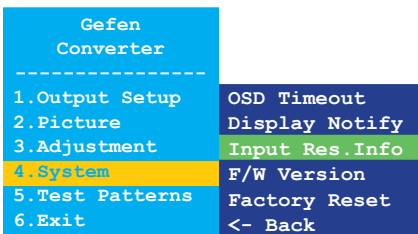

9. To exit the submenu and return to the main menu, use the **Up** or **Dn** button to highlight the **<- Back** option.

Gefen Converter	
-----	
1.Output Setup	OSD Timeout
2.Picture	Display Notify
3.Adjustment	Input Res.Info
4.System	F/W Version
5.Test Patterns	Factory Reset
6.Exit	<- Back

10. Press the **Menu** button to return to the main menu.

Gefen Converter	
-----	
1.Output Setup	OSD Timeout
2.Picture	Display Notify
3.Adjustment	Input Res.Info
4.System	F/W Version
5.Test Patterns	Factory Reset
6.Exit	<- Back

11. To exit the menu system, use the **Up** or **Dn** button to highlight the **Exit** option:

Gefen Converter	
-----	
1.Output Setup	
2.Picture	
3.Adjustment	
4.System	
5.Test Patterns	
6.Exit	

12. Press the **Menu** button to select the **Exit** option.
13. The menu system is now hidden. To display the menu system again, press the **Menu** button.



### Information

By default, the menu system will automatically time-out if no action is taken within 5 seconds. To exit the menu system manually (before the time-out period), highlight the **Exit** option then press the **Menu** button.

See OSD Timeout (page 36) for more information.

## Output Resolution



### Warning

Before changing this setting, make sure that the connected display can support the selected output resolution. If an unsupported resolution is selected, the unit will need to be reset using the DIP switch on the bottom of the unit. See [DIP Switch Configuration \(page 44\)](#) for more information.

1. Press the **Menu** button on the front panel. The **Output Setup** option will be highlighted.
2. Press the **Menu** button to access the **Output Setup** submenu. The **Output Resolu.** option will be highlighted.
3. Press the **Menu** button to select the **Output Resolu.** option.

Gefen Converter -----	
1. Output Setup	Output Resolu.
2. Picture	Output Color
3. Adjustment	Output Mode
4. System	<- Back
5. Test Patterns	
6. Exit	

4. The **Output Resolu.** selection box be displayed:

Output Resolu. ◀ Auto-Detect ▶

5. Use the **Up** or **Dn** button to select the desired resolution. For a list of available output resolutions that are supported by the VGA & Audio to HDMI Scaler/Converter, see [Menu System Summary \(page 126\)](#).
6. After the desired output resolution is selected, press the **Menu** button to confirm the change.
7. After the output resolution has been changed, the current input and output resolution will be displayed above the **Output Resolu.** selection box:

Input	1600x1200p60
Output	640x480p60

(continued on next page)



### Information

The input/output resolution information dialog will only be displayed if **Display Notify** is set to On. See [Display Notify](#) (page 37) for more information.

8. After a few seconds, the input and output resolution information dialog will disappear.
9. The **Output Resolu.** dialog is still displayed:

Output Resolu. ◀ [ 640x480p60 ] ▶

10. Press the **Menu** button to return to the **Output Setup** submenu:

Gefen Converter -----	
1. Output Setup	Output Resolu.
2. Picture	Output Color
3. Adjustment	Output Mode
4. System	<- Back
5. Test Patterns	
6. Exit	

11. Use the **Up** or **Dn** button to select the **<- Back** option.
12. Press the **Menu** button.
13. Use the **Up** or **Dn** button to select the **Exit** option
14. Press the **Menu** button to exit the main menu.

## Output Color

1. Press the **Menu** button on the front panel. The **Output Setup** option will be highlighted.
2. Press the **Menu** button to access the **Output Setup** submenu. The **Output Resolu.** option will be highlighted.
3. Use the **Up** or **Dn** button to highlight the **Output Color** option.

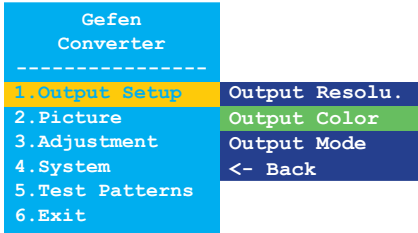

4. Press the **Menu** button to select the **Output Color** option.
5. The **Output Color** selection box will be displayed:



6. Use the **Up** or **Dn** button to select the desired color space.
7. After the desired color space is selected, press the **Menu** button to confirm the change.
8. After the color space has been changed, the current input and output resolution will be displayed above the **Output Color** selection box:

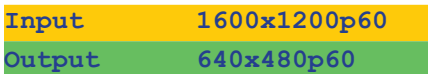

### Information

The input/output resolution information dialog will only be displayed if **Display Notify** is set to On. See [Display Notify](#) (page 37) for more information.

(continued on next page)



9. Press the **Menu** button to return to the **Output Setup** submenu.

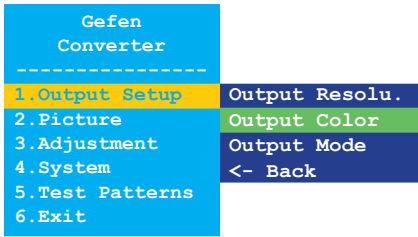

10. Use the **Up** or **Dn** button to select the **<- Back** option.
11. Press the **Menu** button.
12. Use the **Up** or **Dn** button to select the **Exit** option
13. Press the **Menu** button to exit the main menu.

## Output Mode

1. Press the **Menu** button on the front panel. The **Output Setup** option will be highlighted.
2. Press the **Menu** button to access the **Output Setup** submenu. The **Output Resolu.** option will be highlighted.
3. Use the **Up** or **Dn** button to highlight the **Output Mode** option.

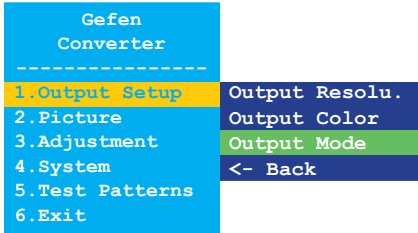

4. Press the **Menu** button to select the **Output Mode** option.
5. The **Output Mode** selection box will be displayed:



6. Use the **Up** or **Dn** button to select between **Auto-Detect**, **HDMI**, or **DVI**.
7. After the desired output mode is selected, press the **Menu** button to confirm the change.
8. The current input and output resolution will be displayed above the current output mode selection.

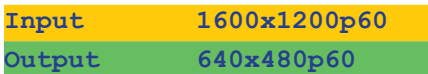

### Information

The input/output resolution information dialog will only be displayed if **Display Notify** is set to On. See [Display Notify](#) (page 37) for more information.

(continued on next page)

9. Press the **Menu** button to return to the **Output Setup** submenu.

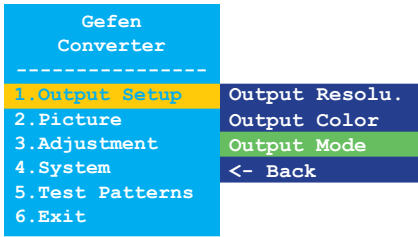

10. Use the **Up** or **Dn** button to select the **<- Back** option.
11. Press the **Menu** button.
12. Use the **Up** or **Dn** button to select the **Exit** option
13. Press the **Menu** button to exit the main menu.

## Contrast

1. Press the **Menu** button on the front panel. The **Output Setup** option will be highlighted.
2. Use the **Up** or **Dn** button to highlight the **Picture** option.
3. Press the **Menu** button to access the **Picture** submenu. The **Contrast** option will be highlighted.

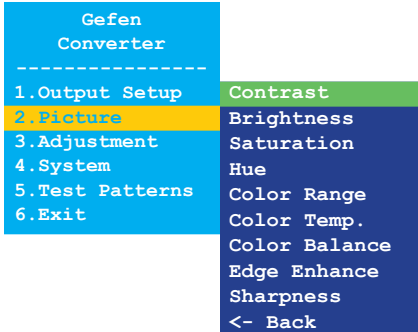

4. Press the **Menu** button to select the **Contrast** option.
5. The **Contrast** selection box will be displayed:



6. Use the **Up** or **Dn** button to set the desired contrast level.
7. Press the **Menu** button to confirm the change and return to the **Picture** submenu.
8. Use the **Up** or **Dn** button to select the **<- Back** option.
9. Press the **Menu** button.
10. Use the **Up** or **Dn** button to select the **Exit** option
11. Press the **Menu** button to exit the main menu.

## Brightness

1. Press the **Menu** button on the front panel. The **Output Setup** option will be highlighted.
2. Use the **Up** or **Dn** button to highlight the **Picture** option.
3. Press the **Menu** button to access the **Picture** submenu. The **Contrast** option will be highlighted.
4. Use the **Up** or **Dn** button to highlight the **Brightness** option.

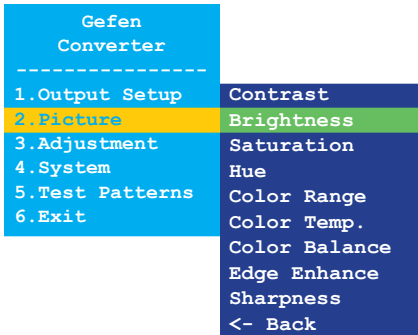

5. Press the **Menu** button to select the **Brightness** option.
6. The **Brightness** selection box will be displayed:



7. Use the **Up** or **Dn** button to set the desired brightness level.
8. Press the **Menu** button to confirm the change and return to **Picture** submenu.
9. Use the **Up** or **Dn** button to select the **<- Back** option.
10. Press the **Menu** button.
11. Use the **Up** or **Dn** button to select the **Exit** option
12. Press the **Menu** button to exit the main menu.

## Saturation

1. Press the **Menu** button on the front panel. The **Output Setup** option will be highlighted.
2. Use the **Up** or **Dn** button to highlight the **Picture** option.
3. Press the **Menu** button to access the **Picture** submenu. The **Contrast** option will be highlighted.
4. Use the **Up** or **Dn** button to highlight the **Saturation** option.

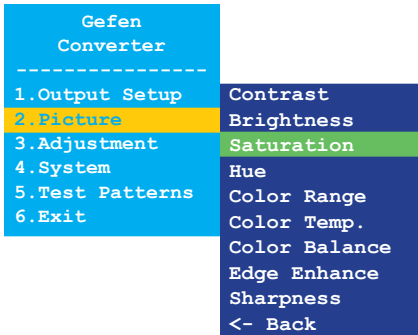

5. Press the **Menu** button to select the **Saturation** option.
6. The **Saturation** selection box will be displayed:



7. Use the **Up** or **Dn** button to set the desired saturation level.
8. Press the **Menu** button to confirm the change and return to the **Picture** submenu.
9. Use the **Up** or **Dn** button to select the **<- Back** option.
10. Press the **Menu** button.
11. Use the **Up** or **Dn** button to select the **Exit** option
12. Press the **Menu** button to exit the main menu.

## Hue

1. Press the **Menu** button on the front panel. The **Output Setup** option will be highlighted.
2. Use the **Up** or **Dn** button to highlight the **Picture** option.
3. Press the **Menu** button to access the **Picture** submenu. The **Contrast** option will be highlighted.
4. Use the **Up** or **Dn** button to highlight the **Hue** option.

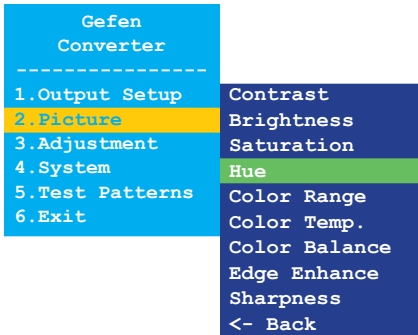

5. Press the **Menu** button to select the **Hue** option.
6. The **Hue** selection box will be displayed:



7. Use the **Up** or **Dn** button to set the desired hue.
8. Press the **Menu** button to confirm the change and return to the **Picture** submenu.
9. Use the **Up** or **Dn** button to select the **<- Back** option.
10. Press the **Menu** button.
11. Use the **Up** or **Dn** button to select the **Exit** option
12. Press the **Menu** button to exit the main menu.

## Color Range

1. Press the **Menu** button on the front panel. The **Output Setup** option will be highlighted.
2. Use the **Up** or **Dn** button to highlight the **Picture** option.
3. Press the **Menu** button to access the **Picture** submenu. The **Contrast** option will be highlighted.
4. Use the **Up** or **Dn** button to highlight the **Color Range** option.

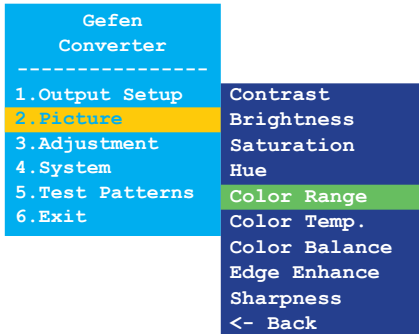

5. Press the **Menu** button to select the **Color Range** option.
6. The **Color Range** selection box will be displayed:

Color Range ◀ Limited ▶

7. Use the **Up** or **Dn** button to select between **Limited** or **Full**.
8. Press the **Menu** button to confirm the change and return to the **Picture** submenu.
9. Use the **Up** or **Dn** button to select the **<- Back** option.
10. Press the **Menu** button.
11. Use the **Up** or **Dn** button to select the **Exit** option
12. Press the **Menu** button to exit the main menu.



## Color Temperature

1. Press the **Menu** button on the front panel. The **Output Setup** option will be highlighted.
2. Use the **Up** or **Dn** button to highlight the **Picture** option.
3. Press the **Menu** button to access the **Picture** submenu. The **Contrast** option will be highlighted.
4. Use the **Up** or **Dn** button to highlight the **Color Temp.** option.

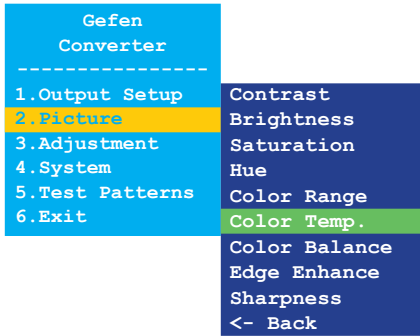

5. Press the **Menu** button to select the **Color Temp.** option.
6. The **Color Temp.** selection box will be displayed:

Color Temp. ◀ Neutral ▶

7. Use the **Up** or **Dn** button to select between **Neutral**, **Cool**, or **Warm**.
8. Press the **Menu** button to confirm the change and return to the **Picture** submenu.
9. Use the **Up** or **Dn** button to select the **<- Back** option.
10. Press the **Menu** button.
11. Use the **Up** or **Dn** button to select the **Exit** option
12. Press the **Menu** button to exit the main menu.

## Color Balance

1. Press the **Menu** button on the front panel. The **Output Setup** option will be highlighted.
2. Use the **Up** or **Dn** button to highlight the **Picture** option.
3. Press the **Menu** button to access the **Picture** submenu. The **Contrast** option will be highlighted.
4. Use the **Up** or **Dn** button to highlight the **Color Balance** option.

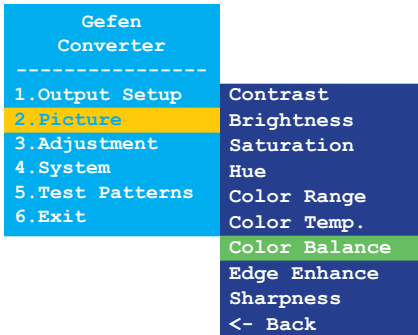

5. Press the **Menu** button to select the **Color Balance** option.
6. The **Color Balance** selection box will be displayed:

Color Balance [ Red Ch. 50 ]

7. Use the **Up** or **Dn** button to switch between **Red Ch.**, **Blue Ch.**, and **Blue Ch.**
8. Press the **Menu** button to select the color channel to adjust.



9. Use the **Up** or **Dn** button to set the desired color balance setting.
10. Press the **Menu** button to confirm the change and return to the **Picture** submenu.
11. Use the **Up** or **Dn** button to select the **<- Back** option.
12. Press the **Menu** button.
13. Use the **Up** or **Dn** button to select the **Exit** option
14. Press the **Menu** button to exit the main menu.

## Edge Enhance

1. Press the **Menu** button on the front panel. The **Output Setup** option will be highlighted.
2. Use the **Up** or **Dn** button to highlight the **Picture** option.
3. Press the **Menu** button to access the **Picture** submenu. The **Contrast** option will be highlighted.
4. Use the **Up** or **Dn** button to highlight the **Edge Enhance** option.

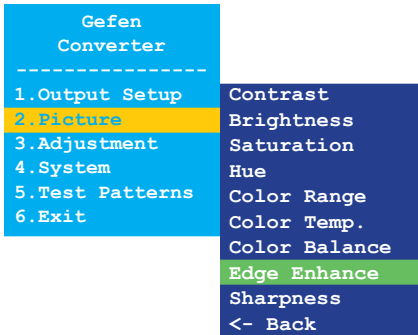

5. Press the **Menu** button to select the **Edge Enhance** option.
6. The **Edge Enhance** selection box will be displayed:

Edge Enhance ◀ [ User ] ▶

7. Use the **Up** or **Dn** button to select between **User**, **Off**, **Mid**, or **Max**.
8. Press the **Menu** button to confirm the change and return to the **Picture** submenu.
9. Use the **Up** or **Dn** button to select the **<- Back** option.
10. Press the **Menu** button.
11. Use the **Up** or **Dn** button to select the **Exit** option
12. Press the **Menu** button to exit the main menu.

## Sharpness

1. Press the **Menu** button on the front panel. The **Output Setup** option will be highlighted.
2. Use the **Up** or **Dn** button to highlight the **Picture** option.
3. Press the **Menu** button to access the **Picture** submenu. The **Contrast** option will be highlighted.
4. Use the **Up** or **Dn** button to highlight the **Sharpness** option.

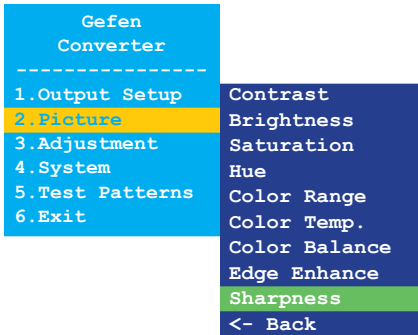

5. Press the **Menu** button to select the **Sharpness** option.
6. The **Sharpness** selection box will be displayed:



7. Use the **Up** or **Dn** button to set the sharpness level. Larger values increase the sharpness of the image.
8. Press the **Menu** button to confirm the change and return to the **Picture** submenu.
9. Use the **Up** or **Dn** button to select the **<- Back** option.
10. Press the **Menu** button.
11. Use the **Up** or **Dn** button to select the **Exit** option
12. Press the **Menu** button to exit the main menu.

## Underscan/Overscan

1. Press the **Menu** button on the front panel. The **Output Setup** option will be highlighted.
2. Use the **Up** or **Dn** button to highlight the **Adjustment** option.
3. Press the **Menu** button to access the **Adjustment** submenu. The **Under/Over Scan** option will be highlighted.

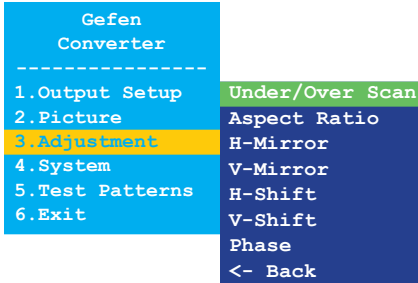

4. Press the **Menu** button to select the **Under/Over Scan** option.
5. The **Under/Over Scan** selection box will be displayed:



6. Use the **Up** or **Dn** button to set the amount of overscan or underscan. Negative values increase the amount of *underscan*. Positive values increase the amount of *overscan*.
7. Press the **Menu** button to confirm the change and return to the **Adjustment** submenu.
8. Use the **Up** or **Dn** button to select the **<- Back** option.
9. Press the **Menu** button.
10. Use the **Up** or **Dn** button to select the **Exit** option
11. Press the **Menu** button to exit the main menu.

## Aspect Ratio

1. Press the **Menu** button on the front panel. The **Output Setup** option will be highlighted.
2. Use the **Up** or **Dn** button to highlight the **Adjustment** option.
3. Press the **Menu** button to access the **Adjustment** submenu. The **Under/Over Scan** option will be highlighted.
4. Use the **Up** or **Dn** button to highlight the **Aspect Ratio** option.

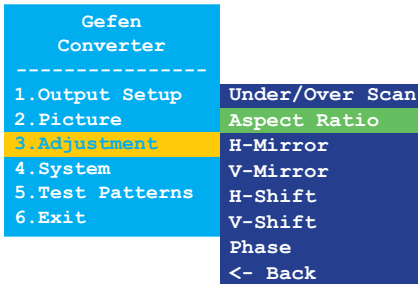

5. Press the **Menu** button to select the **Aspect Ratio** option.
6. The **Aspect Ratio** selection box will be displayed:

Aspect Ratio ◀ [ Source ] ▶

7. Use the **Up** or **Dn** button to select between **Source**, **16:9**, **4:3**, or **Stretch**.
8. Press the **Menu** button to confirm the change and return to the **Adjustment** submenu.
9. Use the **Up** or **Dn** button to select the **<- Back** option.
10. Press the **Menu** button.
11. Use the **Up** or **Dn** button to select the **Exit** option
12. Press the **Menu** button to exit the main menu.

## Horizontal Mirror

1. Press the **Menu** button on the front panel. The **Output Setup** option will be highlighted.
2. Use the **Up** or **Dn** button to highlight the **Adjustment** option.
3. Press the **Menu** button to access the **Adjustment** submenu. The **Under/Over Scan** option will be highlighted.
4. Use the **Up** or **Dn** button to highlight the **H-Mirror** option.

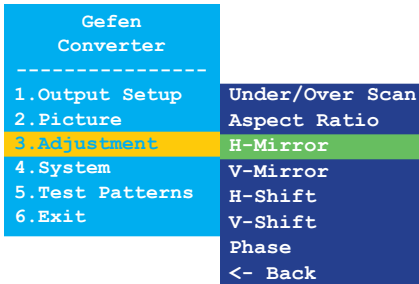

5. Press the **Menu** button to select the **H-Mirror** option.
6. The **H-Mirror** selection box will be displayed:



7. Use the **Up** or **Dn** button to toggle between **On** and **Off**. When the **H-Mirror** option is set to **On**, then the picture will be flipped horizontally (about the Y-axis).



(continued on next page)

8. Press the **Menu** button to confirm the change and return to the **Adjustment** submenu.
9. Use the **Up** or **Dn** button to select the **<- Back** option.
10. Press the **Menu** button.
11. Use the **Up** or **Dn** button to select the **Exit** option
12. Press the **Menu** button to exit the main menu.



## Vertical Mirror

1. Press the **Menu** button on the front panel. The **Output Setup** option will be highlighted.
2. Use the **Up** or **Dn** button to highlight the **Adjustment** option.
3. Press the **Menu** button to access the **Adjustment** submenu. The **Under/Over Scan** option will be highlighted.
4. Use the **Up** or **Dn** button to highlight the **V-Mirror** option.

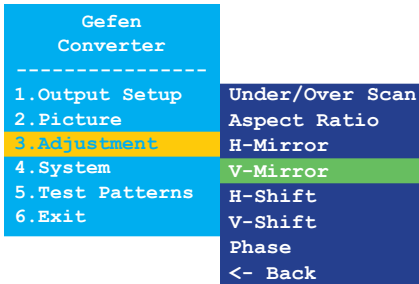

5. Press the **Menu** button to select the **V-Mirror** option.
6. The **V-Mirror** selection box will be displayed:



7. Use the **Up** or **Dn** button to toggle between **On** and **Off**. When the **V-Mirror** option is set to **On**, then the picture will be flipped vertically (about the X-axis).



(continued on next page)

8. Press the **Menu** button to confirm the change and return to the **Adjustment** submenu.
9. Use the **Up** or **Dn** button to select the **<- Back** option.
10. Press the **Menu** button.
11. Use the **Up** or **Dn** button to select the **Exit** option
12. Press the **Menu** button to exit the main menu.

## Horizontal Shift

1. Press the **Menu** button on the front panel. The **Output Setup** option will be highlighted.
2. Use the **Up** or **Dn** button to highlight the **Adjustment** option.
3. Press the **Menu** button to access the **Adjustment** submenu. The **Under/Over Scan** option will be highlighted.
4. Use the **Up** or **Dn** button to highlight the **H-Shift** option.

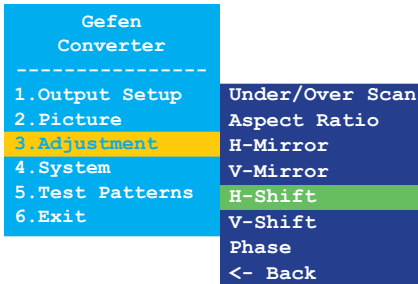

5. Press the **Menu** button to select the **H-Shift** option.
6. The **H-Shift** selection box will be displayed:



7. Use the **Up** or **Dn** button to shift the picture to the left or to the right. Negative values, move the image to the left. Positive values move the image to the right.
8. Press the **Menu** button to confirm the change and return to the **Adjustment** submenu.
9. Use the **Up** or **Dn** button to select the **<- Back** option.
10. Press the **Menu** button.
11. Use the **Up** or **Dn** button to select the **Exit** option
12. Press the **Menu** button to exit the main menu.

## Vertical Shift

1. Press the **Menu** button on the front panel. The **Output Setup** option will be highlighted.
2. Use the **Up** or **Dn** button to highlight the **Adjustment** option.
3. Press the **Menu** button to access the **Adjustment** submenu. The **Under/Over Scan** option will be highlighted.
4. Use the **Up** or **Dn** button to highlight the **V-Shift** option.

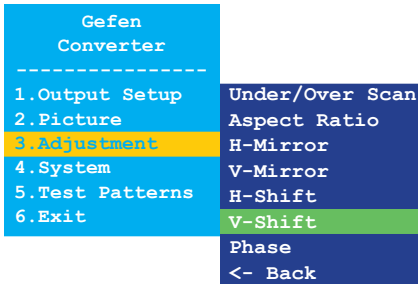

5. Press the **Menu** button to select the **V-Shift** option.
6. The **V-Shift** selection box will be displayed:



7. Use the **Up** or **Dn** button to shift the picture up or down. Negative values, move the image upwards. Positive values move the image downwards.
8. Press the **Menu** button to confirm the change and return to the **Adjustment** submenu.
9. Use the **Up** or **Dn** button to select the **<- Back** option.
10. Press the **Menu** button.
11. Use the **Up** or **Dn** button to select the **Exit** option
12. Press the **Menu** button to exit the main menu.

## Phase

1. Press the **Menu** button on the front panel. The **Output Setup** option will be highlighted.
2. Use the **Up** or **Dn** button to highlight the **Adjustment** option.
3. Press the **Menu** button to access the **Adjustment** submenu. The **Under/Over Scan** option will be highlighted.
4. Use the **Up** or **Dn** button to highlight the **Phase** option.

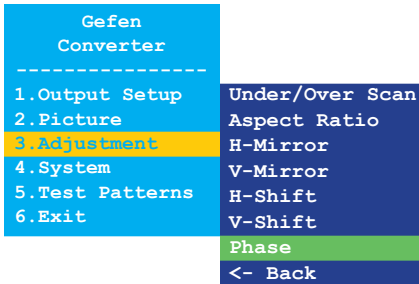

5. Press the **Menu** button to select the **Phase** option.
6. The **Phase** selection box will be displayed:



7. Use the **Up** or **Dn** button to adjust the phase.
8. Press the **Menu** button to confirm the change and return to the **Adjustment** submenu.
9. Use the **Up** or **Dn** button to select the **<- Back** option.
10. Press the **Menu** button.
11. Use the **Up** or **Dn** button to select the **Exit** option
12. Press the **Menu** button to exit the main menu.

## OSD Timeout

1. Press the **Menu** button on the front panel. The **Output Setup** option will be highlighted.
2. Use the **Up** or **Dn** button to highlight the **System** option.
3. Press the **Menu** button to access the **System** submenu. The **OSD Timeout** option will be highlighted.

Gefen Converter	
-----	
1.Output Setup	OSD Timeout
2.Picture	Display Notify
3.Adjustment	Input Res.Info
4.System	F/W Version
5.Test Patterns	Factory Reset
6.Exit	<- Back

4. Press the **Menu** button to select the **OSD Timeout** option.
5. The **OSD Timeout** selection box will be displayed:

OSD Timeout ◀ 5sec ▶

6. Use the **Up** or **Dn** button to set the OSD timeout to **Off** or from any time interval between 5 and 60 seconds, inclusive. The default setting is 5 seconds.
7. Press the **Menu** button to confirm the change and return to the **System** submenu.
8. Use the **Up** or **Dn** button to select the **<- Back** option.
9. Press the **Menu** button.
10. Use the **Up** or **Dn** button to select the **Exit** option
11. Press the **Menu** button to exit the main menu.

## Display Notify

1. Press the **Menu** button on the front panel. The **Output Setup** option will be highlighted.
2. Use the **Up** or **Dn** button to highlight the **System** option.
3. Press the **Menu** button to access the **System** submenu. The **OSD Timeout** option will be highlighted.
4. Use the **Up** or **Dn** button to highlight the **Display Notify** option.

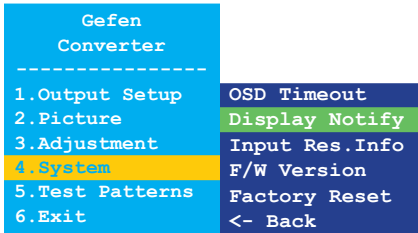

5. Press the **Menu** button to select the **Display Notify** option.
6. The **Display Notify** selection box will be displayed:

Display Notify ◀ [ On ] ▶

7. Use the **Up** or **Dn** button to toggle between **On** and **Off**. When **Display Notify** is set to **On**, then the input/output resolution information dialog will be displayed, momentarily, whenever the VGA & Audio to HDMI Scaler/Converter is disconnected from the source or display:

Input	1600x1200p60
Output	640x480p60

In addition, the following operations also trigger the input/output resolution information dialog: [Output Resolution \(page 12\)](#), [Output Color \(page 14\)](#), or [Output Mode \(page 16\)](#). When set to **Off**, the input/output resolution information dialog is never displayed.

(continued on next page)

8. Press the **Menu** button to confirm the change and return to the **System** submenu.
9. Use the **Up** or **Dn** button to select the **<- Back** option.
10. Press the **Menu** button.
11. Use the **Up** or **Dn** button to select the **Exit** option
12. Press the **Menu** button to exit the main menu.



## Input Resolution Information

1. Press the **Menu** button on the front panel. The **Output Setup** option will be highlighted.
2. Use the **Up** or **Dn** button to highlight the **System** option.
3. Press the **Menu** button to access the **System** submenu. The **OSD Timeout** option will be highlighted.
4. Use the **Up** or **Dn** button to highlight the **Input Res. Info** option.

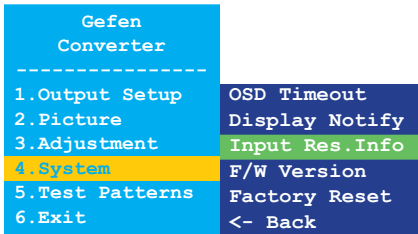

5. Press the **Menu** button to select the **Input Res. Info** option.
6. The current input resolution will be displayed in the **Input Res. Info** box.

Input Res. Info ◀ [ 1600x1200p60 ] ▶

7. Press the **Menu** button to return to the **System** submenu.
8. Use the **Up** or **Dn** button to select the **<- Back** option.
9. Press the **Menu** button.
10. Use the **Up** or **Dn** button to select the **Exit** option
11. Press the **Menu** button to exit the main menu.

## F/W Version

1. Press the **Menu** button on the front panel. The **Output Setup** option will be highlighted.
2. Use the **Up** or **Dn** button to highlight the **System** option.
3. Press the **Menu** button to access the **System** submenu. The **OSD Timeout** option will be highlighted.
4. Use the **Up** or **Dn** button to highlight the **F/W Version** option.

Gefen Converter	
-----	
1.Output Setup	OSD Timeout
2.Picture	Display Notify
3.Adjustment	Input Res.Info
4.System	F/W Version
5.Test Patterns	Factory Reset
6.Exit	<- Back

5. Press the **Menu** button to select the **F/W Version** option.
6. The current version of firmware will be displayed in the **F/W Version** box.

F/W Version ◀ [ V1.012 ] ▶

7. Press the **Menu** button to return to the **System** submenu.
8. Use the **Up** or **Dn** button to select the **<- Back** option.
9. Press the **Menu** button.
10. Use the **Up** or **Dn** button to select the **Exit** option
11. Press the **Menu** button to exit the main menu.

## Factory Reset

1. Press the **Menu** button on the front panel. The **Output Setup** option will be highlighted.
2. Use the **Up** or **Dn** button to highlight the **System** option.
3. Press the **Menu** button to access the **System** submenu. The **OSD Timeout** option will be highlighted.
4. Use the **Up** or **Dn** button to highlight the **Factory Reset** option.

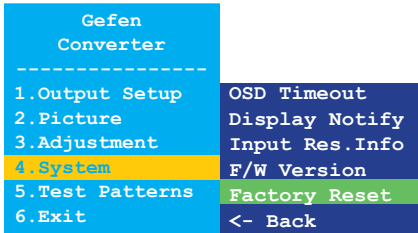

5. Press the **Menu** button to select the **Factory Reset** option.
6. The **Factory Reset** selection box will be displayed.



7. Use the **Up** or **Dn** button to toggle between **No** and **Yes**.
  - ▶ If **Yes** is selected, then the VGA & Audio to HDMI Scaler/Converter will reset to factory-default settings and will automatically reboot.
  - ▶ If **No** is selected, then the VGA & Audio to HDMI Scaler/Converter will return to the **System** submenu.
    - a. Use the **Up** or **Dn** button to select the **<- Back** option.
    - b. Press the **Menu** button.
    - c. Use the **Up** or **Dn** button to select the **Exit** option.
    - d. Press the **Menu** button to exit the main menu.

## Test Patterns

1. Press the **Menu** button on the front panel. The **Output Setup** option will be highlighted.
2. Use the **Up** or **Dn** button to highlight the **Test Patterns** option.
3. Press the **Menu** button to access the **Test Patterns** submenu. The **White** option will be highlighted.

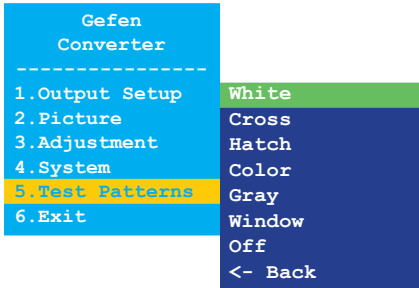

4. Use the **Up** or **Dn** button to highlight the desired test pattern.
5. Press the **Menu** button to select the highlighted test pattern.

**White**

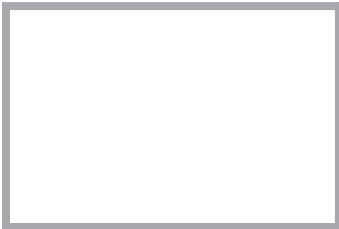

**Cross**

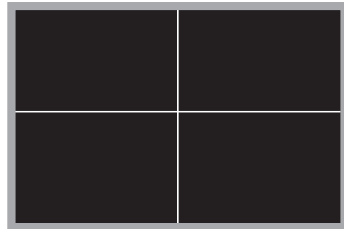

**Hatch**

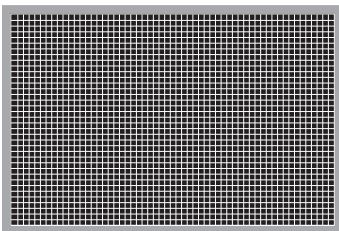

**Color**



(continued on next page)

Gray

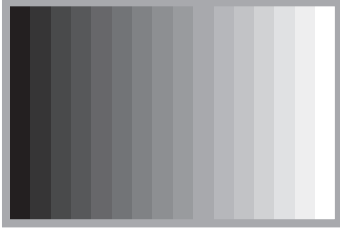

Window

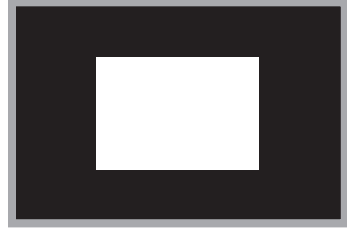



6. Press the **Menu** button to return to the **Test Patterns** submenu and select a different pattern.
7. To disable the pattern and view the source image, select **Off** from the **Test Patterns** submenu.

# DIP Switch Configuration

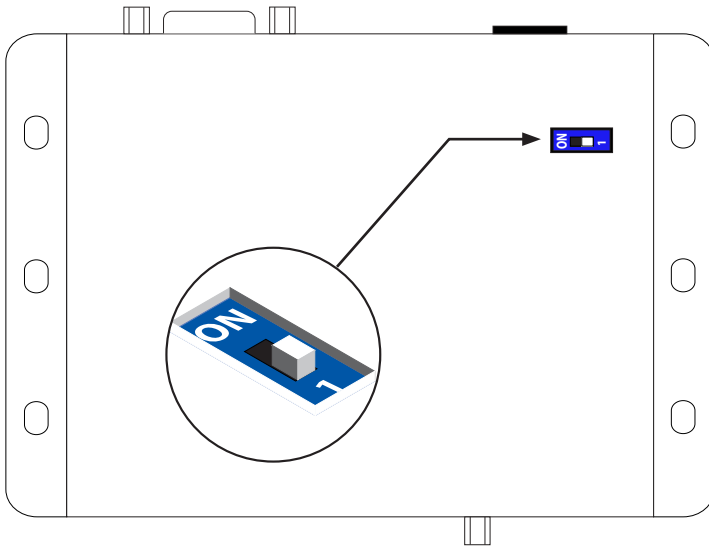
On the bottom panel of the VGA & Audio to HDMI Scaler/Converter is a single DIP switch. Remove the piece of colored tape to reveal the DIP switch bank.



By default, the DIP switch is in the OFF (1) position. The DIP switch should remain in this position during normal operation.

DIP Switch	Description	
1	<p>Factory reset</p> <ul style="list-style-type: none"><li>Toggle the DIP switch from the OFF (1) position to the ON position, then back to the OFF (1) position.</li></ul>	
	<p>Normal Operation</p> <ul style="list-style-type: none"><li>DIP switch is in the OFF (1) position.</li></ul>	







# VGA & Audio to HDMI Scaler/Converter

## 3

## Advanced Operation

USB Interface .....	48
Installing the Virtual COM Port.....	48
Commands .....	50
Using Preset Values.....	52

## Installing the Virtual COM Port

In order to control the VGA & Audio to HDMI Scaler/Converter using the following commands, a virtual COM port must be installed on the computer that is connected to the VGA & Audio to HDMI Scaler/Converter.

1. Install the Gefen Syner-G Software Suite. This software is available under the **Support > Downloads** section of the Gefen website.
2. Connect a mini-USB-to-USB cable (not included) from the **USB** port on the VGA & Audio to HDMI Scaler/Converter to an available USB port on the host computer.
3. From the Windows Desktop, click the **Start** button, select **Computer**, then right-click on **Manage**.

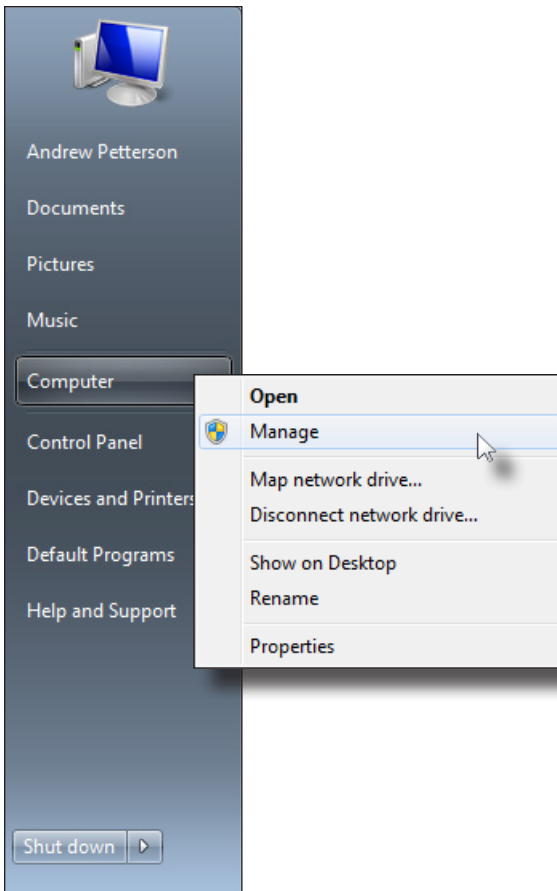

6. The **Computer Management** window will open.
7. In the left window pane, under **System Tools**, click **Device Manager**.
8. In the right window pane, locate **Ports (COM & LPT)**. The device **EXT-VGAA-HD-SC** will be displayed along with the COM port.

Use this COM port when configuring the terminal program (e.g. Hyperterminal).

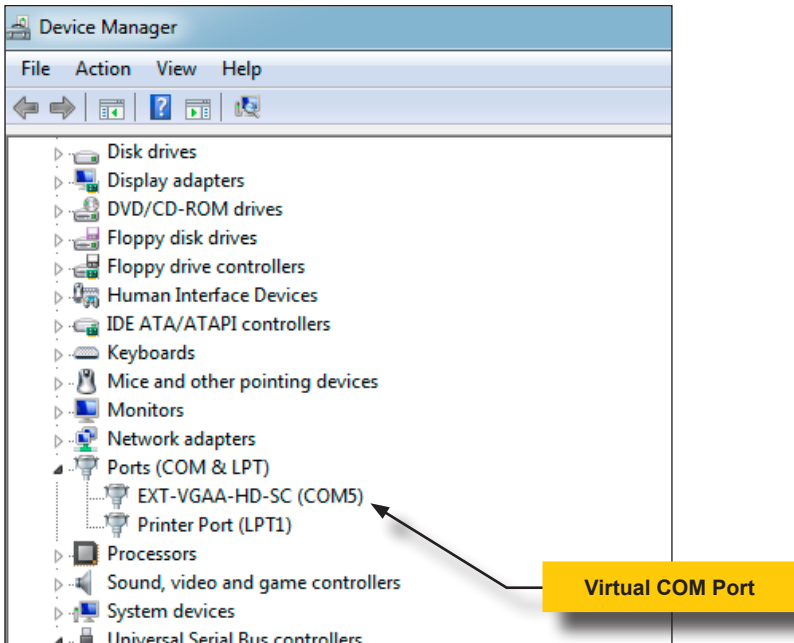

Set the terminal program to the following:

Description	Setting
Baud rate	19200
Data bits	8
Parity	None
Stop bits	1
Hardware flow control	None

Command	Description
#factory_reset	Resets the unit to factory-default settings
#fw_upgrade	Enables the firmware upgrade mode
#get_aspect_ratio	Displays the current aspect ratio setting
#get_brightness	Displays the current brightness setting
#get_color_balance	Displays the value of the specified color channel
#get_color_range	Displays the current color range setting
#get_color_temp	Displays the current color temperature setting
#get_contrast	Displays the current contrast setting
#get_display_notify	Displays the current display-notify setting
#get_edge_enhance	Displays the current edge-enhance setting
#get_firmware_version	Displays the firmware version number
#get_horizontal_mirror	Displays the state of the horizontal mirror setting
#get_horizontal_shift	Displays the state of the horizontal shift setting
#get_hue	Displays the current hue setting
#get_input_resolution	Displays the current input resolution
#get_osd_timeout	Displays the current OSD timeout value
#get_output_color	Displays the current output color space
#get_output_mode	Displays the current output mode
#get_output_res	Displays the current output resolution
#get_phase	Displays the current phase setting
#get_picture_settings	Displays the current picture settings
#get_saturation	Displays the current saturation setting
#get_sharpness	Displays the current sharpness setting
#get_test_patterns	Displays the currently active test pattern
#get_timing_preset	Display the timing of the selected preset
#get_uo_scan	Displays the current underscan/overscan value
#get_vertical_mirror	Displays the current vertical mirror state
#get_vertical_shift	Displays the current vertical shift value
#get_video_output	Displays the current video output settings
#get_video_settings	Displays the current video settings
#help	Displays all available commands
#reboot	Reboots the unit
#set_aspect_ratio	Sets the aspect ratio
#set_brightness	Sets the picture brightness

(continued on next page)

Command	Description
#set_color_balance	Sets the color balance
#set_color_range	Set the output color range
#set_color_temp	Sets the color temperature
#set_contrast	Sets the picture contrast
#set_display_notify	Enables / disables display notifications
#set_edge_enhance	Sets the edge enhancement
#set_horizontal_mirror	Sets horizontal mirror
#set_horizontal_shift	Sets horizontal shift
#set_horz_active	Sets the horizontal active
#set_horz_back_porch	Sets the horizontal back porch
#set_horz_front_porch	Sets the horizontal front porch
#set_horz_scan_rate	Sets the horizontal scan rate
#set_horz_sync_polarity	Sets the horizontal sync polarity
#set_horz_sync_width	Sets the horizontal sync width
#set_horz_total	Sets the total horizontal pixels
#set_hue	Sets the picture hue
#set_osd_timeout	Sets the OSD (On-Screen Display) timeout
#set_output_color	Sets the output color space
#set_output_mode	Sets the output mode
#set_output_res	Sets the output resolution
#set_phase	Sets the phase adjustment
#set_pixel_clock	Sets the pixel clock
#set_saturation	Sets the picture saturation
#set_sharpness	Sets the picture sharpness
#set_test_patterns	Set the test pattern
#set_uo_scan	Set underscan / overscan
#set_vert_active	Sets the vertical active pixels
#set_vert_back_porch	Sets the vertical back porch
#set_vert_front_porch	Sets the vertical front porch
#set_vert_refresh_rate	Sets the vertical refresh rate
#set_vert_sync_polarity	Sets the vertical sync polarity
#set_vert_sync_width	Sets the vertical sync width
#set_vert_total	Sets the total vertical pixels
#set_vertical_mirror	Sets the vertical mirror
#set_vertical_shift	Sets the vertical shift

## Using Preset Values

When a command is entered, the VGA & Audio to HDMI Scaler/Converter will confirm the entry by returning the function of the command and any parameters. There are several commands which use a preset value as one of the parameters. When specifying a preset value as a parameter, the returned preset value will always be one greater than the value that was specified.

For example, if we look up the `#get_timing_preset` command, we will see that this command accepts a single preset value, where *param1* is a value from 0 to 5:

```
#get_timing_preset [param1]
```

If we set *param1* = 2, then the return value will be displayed as 3:

```
#get_timing_preset 2
Preset 3
Hor Scan = 45.0
Hor Active = 1280
Hor Ft Porch = 110
Hor Sync W = 40
Hor Bk Porch = 220
Hor Total = 1650
Hor Polarity = +

Pixel Clk = 74.25

Ver Refresh = 60.0
Ver Active = 720
Ver Ft Porch = 5
Ver Sync W = 5
Ver Bk Porch = 20
Ver Total = 750
Ver Polarity = +
```

## #factory\_reset

Resets the unit to factory-default settings.

### Syntax

```
#factory_reset
```

### Parameters

*None*

### Example

```
#factory_reset  
RESET TO FACTORY DEFAULTS
```

### Related Commands

```
#reboot
```

## #fw\_upgrade

Enables the firmware upgrade mode. We recommend that the Gefen Syner-G Software Suite be used to upgrade the firmware.

### Syntax

```
#fw_upgrade
```

### Parameters

*None*

### Example

```
#fw_upgrade  
Waiting for firmware file to be received...
```

### Related Commands

```
#get_firmware_version
```



## #get\_aspect\_ratio

Displays the current aspect ratio setting.

### Syntax

```
#get_aspect_ratio
```

### Parameters

*None*

### Example

```
#get_aspect_ratio  
ASPECT_RATIO IS Source
```

### Related Commands

```
#get_video_settings  
#set_aspect_ratio
```

## #get\_brightness

Displays the current brightness value.

### Syntax

```
#get_brightness
```

### Parameters

*None*

### Example

```
#get_brightness  
PICTURE BRIGHTNESS IS 52
```

### Related Commands

```
#set_brightness
```

## #get\_color\_balance

Displays the current color balance for the specified color channel.

### Syntax

```
#get_color_balance param1
```

### Parameters

*param1*                      Color channel                      [0 ... 2]

param1	Description
0	Red channel
1	Green channel
2	Blue channel

### Example

```
#get_color_balance 1  
PICTURE COLOR BALANCE Green Channel IS 50
```

### Related Commands

```
#set_color_balance
```

## #get\_color\_range

Displays the current color range setting.

### Syntax

```
#get_color_range
```

### Parameters

*None*

### Example

```
#get_color_range  
PICTURE COLOR RANGE IS Limited
```

### Related Commands

```
#set_color_range
```

## #get\_color\_temp

Displays the current color temperature setting.

### Syntax

```
#get_color_temp
```

### Parameters

*None*

### Example

```
#get_color_temp  
PICTURE COLOR TEMPERATURE IS Neutral
```

### Related Commands

```
#set_color_temp
```

## #get\_contrast

Displays the current contrast setting.

### Syntax

```
#get_contrast
```

### Parameters

*None*

### Example

```
#get_contrast  
PICTURE CONTRAST IS 68
```

### Related Commands

```
#set_contrast
```

## #get\_display\_notify

Displays the current display-notify setting. Refer to the #set\_display\_notify command for more information about Display Notification.

### Syntax

```
#get_display_notify
```

### Parameters

*None*

### Example

```
#get_display_notify  
DISPLAY NOTIFICATIONS IS On
```

### Related Commands

```
#set_display_notify
```

## #get\_edge\_enhance

Displays the current edge-enhance setting.

### Syntax

```
#get_edge_enhance
```

### Parameters

*None*

### Example

```
#get_edge_enhance  
PICTURE EDGE ENHANCEMENT IS Off
```

### Related Commands

```
#set_edge_enhance
```



## #get\_firmware\_version

Displays the current firmware version.

### Syntax

```
#get_firmware_version
```

### Parameters

*None*

### Example

```
#get_firmware_version  
FIRMWARE VERSION IS V1.012
```

### Related Commands

```
#fw_upgrade
```

## #get\_horizontal\_mirror

Displays the horizontal mirror setting.

### Syntax

```
#get_horizontal_mirror
```

### Parameters

*None*

### Example

```
#get_horizontal_mirror  
HORIZONTAL MIRROR IS Off
```

### Related Commands

```
#get_vertical_mirror  
#set_horizontal_mirror
```

## #get\_horizontal\_shift

Displays the current horizontal shift setting.

### Syntax

```
#get_horizontal_shift
```

### Parameters

*None*

### Example

```
#get_horizontal_shift  
HORIZONTAL SHIFT IS Off
```

### Related Commands

```
#set_horizontal_shift
```

## #get\_hue

Displays the current hue setting.

### Syntax

```
#get_hue
```

### Parameters

*None*

### Example

```
#get_hue  
PICTURE HUE IS 50
```

### Related Commands

```
#get_brightness  
#get_contrast  
#get_saturation  
#set_hue
```

## #get\_input\_resolution

Displays the current input resolution.

### Syntax

```
#get_input_resolution
```

### Parameters

*None*

### Example

```
#get_input_resolution  
INPUT RESOLUTION IS 1600x1200p60
```

### Related Commands

```
#get_picture_settings
```

## #get\_osd\_timeout

Displays the current OSD timeout value (in seconds).

### Syntax

```
#get_osd_timeout
```

### Parameters

*None*

### Example

```
#get_osd_timeout  
OSD TIMEOUT IS 5 SECONDS
```

### Related Commands

```
#set_osd_timeout
```

## #get\_output\_color

Displays the current output color space.

### Syntax

```
#get_output_color
```

### Parameters

*None*

### Example

```
#get_output_color  
OUTPUT COLOR SPACE IS RGB 4:4:4
```

### Related Commands

```
#get_color_range  
#get_color_temp  
#set_output_color
```

## #get\_output\_mode

Displays the current output mode.

### Syntax

```
#get_output_mode
```

### Parameters

*None*

### Example

```
#get_output_mode  
OUTPUT MODE IS Auto Detect
```

### Related Commands

```
#get_output_color  
#set_output_mode
```



## #get\_output\_res

Displays the current output resolution.

### Syntax

```
#get_output_res
```

### Parameters

*None*

### Example

```
#get_output_res  
OUTPUT RESOLUTION IS 1400x1050 60Hz
```

### Related Commands

```
#set_output_res
```

## #get\_phase

Displays the current phase setting.

### Syntax

```
#get_phase
```

### Parameters

*None*

### Example

```
#get_phase  
PHASE IS 26
```

### Related Commands

```
#get_video_settings  
#set_phase
```

## #get\_picture\_settings

Displays the current picture settings. This command provides the same information as consecutively executing the following commands: #get\_contrast, #get\_brightness, #get\_saturation, #get\_hue, get\_color\_range, #get\_color\_temp, #get\_color\_balance, #get\_edge\_enhance, and #get\_sharpness.

### Syntax

```
#get_picture_settings
```

### Parameters

*None*

### Example

```
#get_picture_settings
PICTURE CONTRAST IS 50
PICTURE BRIGHTNESS IS 50
PICTURE SATURATION IS 50
PICTURE HUE IS 50
PICTURE COLOR RANGE IS Limited
PICTURE COLOR TEMPERATURE IS Neutral
PICTURE COLOR BALANCE Red Channel IS 50
PICTURE COLOR BALANCE Green Channel IS 50
PICTURE COLOR BALANCE Blue Channel IS 50
PICTURE EDGE ENHANCEMENT IS Off
PICTURE SHARPNESS IS 0
```

### Related Commands

#get_brightness	#set_brightness
#get_contrast	#set_contrast
#get_color_balance	#set_color_balance
#get_color_range	#set_color_range
#get_color_temp	#set_color_temp
#get_edge_enhance	#set_edge_enhance
#get_hue	#set_hue
#get_saturation	#set_saturation
#get_sharpness	#set_sharpness

## #get\_saturation

Displays the current saturation value.

### Syntax

```
#get_saturation
```

### Parameters

*None*

### Example

```
#get_saturation  
PICTURE SATURATION IS 50
```

### Related Commands

```
#get_contrast  
#get_brightness  
#get_hue  
#get_color_range  
#get_color_temp  
#get_edge_enhance  
#get_sharpness
```

## #get\_sharpness

Displays the current sharpness value.

### Syntax

```
#get_sharpness
```

### Parameters

*None*

### Example

```
#get_sharpness  
PICTURE SHARPNESS IS 0
```

### Related Commands

```
#get_contrast  
#get_brightness  
#get_saturation  
#get_hue  
#get_color_range  
#get_color_temp  
#get_edge_enhance
```

## #get\_test\_patterns

Displays the currently active test pattern.

### Syntax

```
#get_test_patterns
```

### Parameters

*None*

### Example

```
#get_test_patterns  
TEST PATTERNS IS Off
```

### Related Commands

```
#set_test_patterns
```

## #get\_timing\_preset

Displays the values for the specified timing preset.

### Syntax

```
#get_timing_preset
```

### Parameters

<i>param1</i>	Preset	[0 ... 5]
---------------	--------	-----------

### Example

```
#get_timing_preset 1
Preset 2
Hor Scan = 45.0
Hor Active = 1280
Hor Ft Porch = 110
Hor Sync W = 40
Hor Bk Porch = 220
Hor Total = 1650
Hor Polarity = +

Pixel Clk = 74.25

Ver Refresh = 60.0
Ver Active = 720
Ver Ft Porch = 5
Ver Sync W = 5
Ver Bk Porch = 20
Ver Total = 750
Ver Polarity = +
```

### Related Commands

#set_horz_scan_rate	#set_vert_refresh_rate
#set_horz_active	#set_vert_active
#set_horz_front_porch	#set_vert_front_porch
#set_horz_sync_width	#set_vert_sync_width
#set_horz_back_porch	#set_vert_back_porch
#set_horz_total	#set_vert_total
#set_horz_sync_polarity	#set_vert_sync_polarity
#set_pixel_clock	

## #get\_uo\_scan

Displays the current underscan or overscan value.

### Syntax

```
#get_uo_scan
```

### Parameters

*None*

### Example

```
#get_uo_scan  
UNDER/OVER SCAN IS OFF
```

### Related Commands

```
#set_uo_scan
```



## #get\_vertical\_mirror

Displays the current vertical mirror value.

### Syntax

```
#get_vertical_mirror
```

### Parameters

*None*

### Example

```
#get_vertical_mirror  
VERTICAL MIRROR IS Off
```

### Related Commands

```
#get_horizontal_mirror  
#set_vertical_mirror
```

## #get\_vertical\_shift

Displays the current vertical shift value.

### Syntax

```
#get_vertical_shift
```

### Parameters

*None*

### Example

```
#get_vertical_shift  
VERTICAL SHIFT IS OFF
```

### Related Commands

```
#get_horizontal_shift  
#set_vertical_shift
```

## #get\_video\_output

Displays the current video output settings. This command produces the same output as consecutively executing the #get\_output\_res, #get\_output\_color, and #get\_output\_mode commands.

### Syntax

```
#get_video_output
```

### Parameters

*None*

### Example

```
#get_video_output  
OUTPUT RESOLUTION IS 1400x1050 60Hz  
OUTPUT COLOR SPACE IS RGB 4:4:4  
OUTPUT MODE IS Auto Detect
```

### Related Commands

```
#get_output_res  
#get_output_color  
#get_output_mode  
#set_output_res  
#set_output_color  
#set_output_mode
```

## #get\_video\_settings

Displays the current video settings. This command provides the same information as consecutively executing the #get\_uo\_scan, #get\_aspect\_ratio, #get\_horizontal\_mirror, #get\_vertical\_mirror, #get\_horizontal\_shift, #get\_vertical\_shift, and #get\_phase commands.

### Syntax

```
#get_video_settings
```

### Parameters

*None*

### Example

```
#get_video_settings
UNDER/OVER SCAN IS OFF
ASPECT RATIO IS Source
HORIZONTAL MIRROR IS Off
VERTICAL MIRROR IS Off
HORIZONTAL SHIFT IS OFF
VERTICAL SHIFT IS OFF
PHASE IS AUTO
```

### Related Commands

```
#get_uo_scan
#get_aspect_ratio
#get_horizontal_mirror
#get_horizontal_shift
#get_phase
#get_vertical_mirror
#get_vertical_shift
#set_aspect_ratio
#set_horizontal_mirror
#set_horizontal_shift
#set_phase
#set_vertical_mirror
#set_vertical_shift
```

## #help

Displays help on a specific command. If no command is specified (*param1*), then a list of all available commands will be displayed.

### Syntax

```
#help [param1]
```

### Parameters

<i>param1</i>	Command (optional)
---------------	--------------------

### Examples

```
#help
```

```
#FACTORY_RESET
#FW_UPGRADE
#GET_ASPECT_RATIO
#GET_BRIGHTNESS
#SET_COLOR_BALANCE
#GET_COLOR_RANGE
#GET_COLOR_TEMP
#GET_CONTRAST
#GET_DISPLAY_NOTIFY
#GET_EDGE_ENHANCE
...
...
#SET_VERT_SYNC_WIDTH
#SET_VERT_TOTAL
#SET_VERTICAL_MIRROR
#SET_VERTICAL_SHIFT
```

```
#help #set_aspect_ratio
```

```
#SET_ASPECT_RATIO
Set aspect ratio
#SET_ASPECT_RATIO PARAM 1
PARAM 1= 0-3
0 - 16:9
1 - 4:3
2 - Stretch
3 - Source
```

## #reboot

Reboots the unit.

### Syntax

```
#reboot
```

### Parameters

*None*

### Example

```
#reboot  
UNIT WILL REBOOT SHORTLY
```

### Related Commands

```
#factory_reset
```

## #set\_aspect\_ratio

Sets the aspect ratio of the output video signal. The default setting is 0.

### Syntax

```
#set_aspect_ratio param1
```

### Parameters

*param1* Aspect ratio [0 ... 3]

param1	Description
0	16:9
1	4:3
2	Stretch
3	Source

### Example

```
#set_aspect_ratio 1  
ASPECT RATIO SET TO 4:3
```

### Related Commands

```
#get_aspect_ratio
```

## #set\_brightness

Sets the brightness of the output video signal. The default setting is 50.

### Syntax

```
#set_brightness param1
```

### Parameters

<i>param1</i>	Brightness	[0 ... 100]
---------------	------------	-------------

### Example

```
#set_brightness 58  
PICTURE BRIGHTNESS SET TO 58
```

### Related Commands

```
#get_brightness  
#set_color_balance  
#set_color_range  
#set_contrast  
#set_hue
```



## #set\_color\_balance

Sets the color balance of the output video signal.

### Syntax

```
#set_color_balance param1 param2
```

### Parameters

*param1*                      Color channel                      [0 ... 2]

param1	Description
0	Red
1	Green
2	Blue

*param2*                      Intensity                      [0 ... 100]

### Example

```
#set_color_balance 1 90
PICTURE COLOR BALANCE Green Channel SET TO 90
```

### Related Commands

```
#get_color_balance
#set_color_range
#set_color_temp
```

## #set\_color\_range

Sets the color range of the output video signal.

### Syntax

```
#set_color_range param1
```

### Parameters

*param1*                      Color range                      [0 ... 1]

param1	Description
0	Full (0 - 255)
1	Limited (16 - 235)

### Example

```
#set_color_range 1
PICTURE COLOR RANGE SET TO Limited
```

### Related Commands

```
#get_color_range
#set_color_balance
#set_color_temp
```

## #set\_color\_temp

Sets the color temperature of the output video signal.

### Syntax

```
#set_color_temp param1
```

### Parameters

*param1*                      Color temperature                      [0 ... 2]

param1	Description
0	Warm
1	Neutral
2	Cool

### Example

```
#set_color_temp 2  
PICTURE COLOR TEMPERATURE SET TO Cool
```

### Related Commands

```
#get_color_temp  
#set_color_balance  
#set_color_range
```

## #set\_contrast

Sets the contrast of the output video signal.

### Syntax

```
#set_contrast param1
```

### Parameters

<i>param1</i>	Contrast	[0 ... 100]
---------------	----------	-------------

### Example

```
#set_contrast 40  
PICTURE CONTRAST SET TO 40
```

### Related Commands

```
#get_contrast  
#set_brightness  
#set_hue  
#set_saturation
```

## #set\_display\_notify

Enables / disables the input/output resolution information dialog. When set to On, the input/output resolution information dialog will be displayed, momentarily, whenever the source is disconnected / reconnected to the VGA & Audio to HDMI Scaler/Converter or if a change to the output is made. When set to Off, the information dialog will not be displayed.

### Syntax

```
#set_display_notify param1
```

### Parameters

*param1* State [0 ... 1]

param1	Description
0	Off
1	On

### Example

```
#set_display_notify 1  
DISPLAY NOTIFICATIONS SET TO On
```

### Related Commands

```
#get_display_notify
```

## #set\_edge\_enhance

Sets the picture edge enhancement (sharpness) threshold. The Mid and Max settings are sharpness presets. To set the sharpness to a specific setting, set *param1* = 3, then use the `#set_sharpness` command to set the sharpness value.

### Syntax

```
#set_edge_enhance param1
```

### Parameters

*param1* Edge detail [0 ... 3]

param1	Description
0	Off
1	Mid
2	Max
3	User

### Example

```
#set_edge_enhance 2
PICTURE EDGE ENHANCEMENT SET TO Max
```

### Related Commands

```
#get_edge_enhance
#set_sharpness
```

## #set\_horizontal\_mirror

Enables or disables horizontal mirroring. When set to *on*, the output image is flipped horizontally.

### Syntax

```
#set_horizontal_mirror param1
```

### Parameters

*param1* State [0 ... 1]

param1	Description
0	Off
1	On

### Example

```
#set_horizontal_mirror 1  
HORIZONTAL MIRROR SET TO On
```

### Related Commands

```
#get_horizontal_mirror  
#get_video_settings  
#set_vertical_mirror
```

## #set\_horizontal\_shift

Adjust the horizontal position of the output image.

### Syntax

```
#set_horizontal_shift param1
```

### Parameters

<i>param1</i>	Horizontal shift	[-100 ... 100]
---------------	------------------	----------------

### Example

```
#set_horizontal_shift -20  
HORIZONTAL SHIFT IS SET TO -20
```

### Related Commands

```
#get_horizontal_shift  
#get_video_settings  
#set_vertical_shift
```



## #set\_horz\_active

Sets the number of active horizontal pixels and saves it to the specified preset.

### Syntax

```
#set_horz_active param1 param2
```

### Parameters

<i>param1</i>	Pixels	[0 ... 9999]
<i>param2</i>	Preset	[0 ... 5]

### Example

```
#set_horz_active 1280 1
HORIZONTAL ACTIVE 1280 SAVED TO PRESET 2
```

### Related Commands

```
#get_timing_preset
#set_horz_back_porch
#set_horz_front_porch
#set_horz_scan_rate
#set_horz_sync_polarity
#set_horz_sync_width
#set_horz_total
#set_pixel_clock
#set_vert_active
#set_vert_back_porch
#set_vert_front_porch
#set_vert_refresh_rate
#set_vert_sync_polarity
#set_vert_sync_width
#set_vert_total
```

## #set\_horz\_back\_porch

Sets the horizontal back porch and saves it to the specified preset.

### Syntax

```
#set_horz_back_porch param1 param2
```

### Parameters

<i>param1</i>	Pixels	[0 ... 9999]
<i>param2</i>	Preset	[0 ... 5]

### Example

```
#set_horz_back_porch 220 1
HORIZONTAL BACK PORCH 220 SAVED TO PRESET 2
```

### Related Commands

```
#get_timing_preset
#set_horz_active
#set_horz_front_porch
#set_horz_scan_rate
#set_horz_sync_polarity
#set_horz_sync_width
#set_horz_total
#set_pixel_clock
#set_vert_active
#set_vert_back_porch
#set_vert_front_porch
#set_vert_refresh_rate
#set_vert_sync_polarity
#set_vert_sync_width
#set_vert_total
```

## #set\_horz\_front\_porch

Sets the horizontal front porch and saves it to the specified preset.

### Syntax

```
#set_horz_front_porch param1 param2
```

### Parameters

<i>param1</i>	Pixels	[0 ... 9999]
<i>param2</i>	Preset	[0 ... 5]

### Example

```
#set_horz_front_porch 110 1
HORIZONTAL FRONT PORCH 110 SAVED TO PRESET 2
```

### Related Commands

```
#get_timing_preset
#set_horz_active
#set_horz_back_porch
#set_horz_scan_rate
#set_horz_sync_polarity
#set_horz_sync_width
#set_horz_total
#set_pixel_clock
#set_vert_active
#set_vert_back_porch
#set_vert_front_porch
#set_vert_refresh_rate
#set_vert_sync_polarity
#set_vert_sync_width
#set_vert_total
```

## #set\_horz\_scan\_rate

Sets the horizontal scan rate and saves it to the specified preset. *param1* is a floating-point value and can be specified up to three decimal places.

### Syntax

```
#set_horz_scan_rate param1 param2
```

### Parameters

<i>param1</i>	Scan rate (kHz)	[0.000 ... 999.000]
<i>param2</i>	Preset	[0 ... 5]

### Example

```
#set_horz_scan_rate 45 1
HORIZONTAL SCAN RATE 45 SAVED TO PRESET 2
```

### Related Commands

```
#get_timing_preset
#set_horz_active
#set_horz_back_porch
#set_horz_front_porch
#set_horz_sync_polarity
#set_horz_sync_width
#set_horz_total
#set_pixel_clock
#set_vert_active
#set_vert_back_porch
#set_vert_front_porch
#set_vert_refresh_rate
#set_vert_sync_polarity
#set_vert_sync_width
#set_vert_total
```

## #set\_horz\_sync\_polarity

Sets the horizontal sync polarity and saves it to the specified preset.

### Syntax

```
#set_horz_sync_polarity param1 param2
```

### Parameters

*param1* State [0 ... 1]

param1	Description
0	Negative
1	Positive

*param2* Preset [0 ... 5]

### Example

```
#set_horz_sync_polarity 1 1
HORIZONTAL SYNC POLARITY POSITIVE SAVED TO PRESET 2
```

### Related Commands

```
#get_timing_preset
#set_horz_active
#set_horz_back_porch
#set_horz_front_porch
#set_horz_scan_rate
#set_horz_sync_width
#set_horz_total
#set_pixel_clock
#set_vert_active
#set_vert_back_porch
#set_vert_front_porch
#set_vert_refresh_rate
#set_vert_sync_polarity
#set_vert_sync_width
#set_vert_total
```

## #set\_horz\_sync\_width

Sets the horizontal sync width in pixels and saves it to the specified preset.

### Syntax

```
#set_horz_sync_width param1 param2
```

### Parameters

<i>param1</i>	Width (pixels)	[0 ... 9999]
<i>param2</i>	Preset	[0 ... 5]

### Example

```
#set_horz_sync_width 40 1
HORIZONTAL SYNC WIDTH 40 SAVED TO PRESET 2
```

### Related Commands

```
#get_timing_preset
#set_horz_active
#set_horz_back_porch
#set_horz_front_porch
#set_horz_scan_rate
#set_horz_sync_polarity
#set_horz_total
#set_pixel_clock
#set_vert_active
#set_vert_back_porch
#set_vert_front_porch
#set_vert_refresh_rate
#set_vert_sync_polarity
#set_vert_sync_width
#set_vert_total
```

## #set\_horz\_total

Sets the total number of horizontal pixels and saves it to the specified preset.

### Syntax

```
#set_horz_total param1 param2
```

### Parameters

<i>param1</i>	Total (pixels)	[0 ... 9999]
<i>param2</i>	Preset	[0 ... 5]

### Example

```
#set_horz_total 1650 1
HORIZONTAL TOTAL 1650 SAVED TO PRESET 2
```

### Related Commands

```
#get_timing_preset
#set_horz_active
#set_horz_back_porch
#set_horz_front_porch
#set_horz_sync_polarity
#set_horz_scan_rate
#set_horz_sync_width
#set_pixel_clock
#set_vert_active
#set_vert_back_porch
#set_vert_front_porch
#set_vert_refresh_rate
#set_vert_sync_polarity
#set_vert_sync_width
#set_vert_total
```

## #set\_hue

Sets the picture hue of the output video signal.

### Syntax

```
#set_hue param1
```

### Parameters

<i>param1</i>	Hue	[0 ... 100]
---------------	-----	-------------

### Example

```
#set_hue 60  
PICTURE HUE SET TO 60
```

### Related Commands

```
#get_hue  
#set_brightness  
#set_contrast  
#set_saturation
```



## #set\_osd\_timeout

Sets the OSD (On-Screen Display) time-out delay in seconds. If `param1 = 0`, then the OSD timeout will be set to "off". The OSD will be displayed until it is exited, manually. See [Moving around within the Menu System \(page 9\)](#) for more information on how to manually exit the menu system.

### Syntax

```
#set_osd_timeout param1
```

### Parameters

<i>param1</i>	Timeout	[0, 5 ... 60]
---------------	---------	---------------

### Example

```
#set_osd_timeout 10  
OSD TIMEOUT IS SET TO 10 SECONDS
```

### Related Commands

```
#get_osd_timeout
```

## #set\_output\_color

Sets the output color space.

### Syntax

```
#set_output_color param1
```

### Parameters

*param1*                      Color space                      [0 ... 2]

param1	Description
0	RGB 4:4:4
1	YCbCr 4:4:4
2	YCbCr 4:2:2

### Example

```
#set_output_color 1
OUTPUT COLOR SPACE SET TO YCbCr 4:4:4
```

### Related Commands

```
#get_output_color
#set_color_balance
#set_color_range
#set_color_temp
```

## #set\_output\_mode

Sets the output mode.

### Syntax

```
#set_output_mode param1
```

### Parameters

*param1* Mode [0 ... 2]

param1	Description
0	HDMI
1	DVI
2	Auto Detect

### Example

```
#set_output_mode 0  
OUTPUT MODE SET TO HDMI
```

### Related Commands

```
#get_output_mode
```

## #set\_output\_res

Sets the output resolution. Resolutions that use reduced-blanking are indicated with "(RB)". Note the following frequency information: 23 = 23.98, 29 = 29.97, and 59 = 59.94.

### Syntax

```
#set_output_res param1
```

### Parameters

*param1* Resolution [0 ... 44]

param1	Description
0	640 x 480 / 60 Hz
1	640 x 480 / 75 Hz
2	800 x 600 / 60 Hz
3	800 x 600 / 75 Hz
4	1024 x 768 / 60 Hz
5	1024 x 768 / 75 Hz
6	1280 x 768 / 60 Hz
7	1280 x 800 / 60 Hz
8	1280 x 1024 / 60 Hz
9	1280 x 1024 / 75 Hz
10	1360 x 768 / 60 Hz
11	1366 x 768 / 60 Hz
12	1440 x 900 / 60 Hz
13	1440 x 900 / 75 Hz
14	1400 x 1050 / 60 Hz
15	1680 x 1050 / 60 Hz
16	1680 x 1050 (RB)
17	1920 x 1080 (RB)
18	1920 x 1200 / 60 Hz
19	1920 x 1200 (RB)
20	Bypass
21	Auto-Detect

(continued on next page)

param1	Description
22	SD (480i) / 60 Hz
23	SD (576i) / 50 Hz
24	SD (480p) / 60 Hz
25	SD (576p) / 50 Hz
26	HD (720p) / 60 Hz
27	HD (720p) / 59 Hz
28	HD (720p) / 50 Hz
29	HD (720p) / 30 Hz
30	HD (720p) / 29 Hz
31	HD (720p) / 25 Hz
32	HD (1080i) / 60 Hz
33	HD (1080i) / 59 Hz
34	HD (1080i) / 50 Hz
35	HD (1080p) / 60 Hz
36	HD (1080p) / 59 Hz
37	HD (1080p) / 50 Hz
38	HD (1080p) / 30 Hz
39	HD (1080p) / 29 Hz
40	HD (1080p) / 25 Hz
41	HD (1080p) / 24 Hz
42	HD (1080p) / 23 Hz
43	2048x1080 / 60 Hz
44	2048x1080 / 50 Hz

## Example

```
#set_output_res 2
OUTPUT RESOLUTION SET TO 800x600 60Hz
```

## Related Commands

```
#get_output_res
```

## #set\_phase

Sets the phase adjustment. The default setting is "Auto".

### Syntax

```
#set_phase param1
```

### Parameters

<i>param1</i>	Phase	[Auto, 1 ... 64]
---------------	-------	------------------

### Example

```
#set_phase 26  
PHASE SET TO 26
```

### Related Commands

```
#get_phase
```

## #set\_pixel\_clock

Sets the pixel clock and saves it to the specified preset. *param1* is a floating-point value and can be specified up to three decimal places.

### Syntax

```
#set_pixel_clock param1 param2
```

### Parameters

<i>param1</i>	Pixel clock	[0.000 ... 999.000]
<i>param2</i>	Preset	[0 ... 5]

### Example

```
#set_pixel_clock 74.25 1
PIXEL CLOCK 74.25 SAVED TO PRESET 2
```

### Related Commands

```
#get_timing_preset
#set_horz_active
#set_horz_back_porch
#set_horz_front_porch
#set_horz_sync_polarity
#set_horz_scan_rate
#set_horz_sync_width
#set_horz_total
#set_pixel_clock
#set_vert_active
#set_vert_back_porch
#set_vert_front_porch
#set_vert_refresh_rate
#set_vert_sync_polarity
#set_vert_sync_width
#set_vert_total
```

## #set\_saturation

Sets the picture saturation.

### Syntax

```
#set_saturation param1
```

### Parameters

<i>param1</i>	Saturation	[0 ... 100]
---------------	------------	-------------

### Example

```
#set_saturation 65  
PICTURE SATURATION SET TO 65
```

### Related Commands

```
#set_brightness  
#set_contrast  
#set_hue
```



## #set\_sharpness

Sets the picture saturation. In order to set the sharpness value, the Edge Enhance setting must be set to User. Refer to the [#set\\_edge\\_enhance](#) command for details.

### Syntax

```
#set_sharpness param1
```

### Parameters

<i>param1</i>	Sharpness	[0 ... 100]
---------------	-----------	-------------

### Example

```
#set_sharpness 68  
PICTURE SHARPNESS SET TO 68
```

### Related Commands

[#set\\_edge\\_enhance](#)

## #set\_test\_patterns

Enables / disables or sets the test pattern.

### Syntax

```
#set_test_patterns param1
```

### Parameters

*param1* Pattern [0 ... 6]

param1	Description
0	White
1	Cross
2	Hatch
3	Color
4	Gray
5	Window
6	Off

### Example

```
#set_test_patterns 2
TEST PATTERNS SET TO Hatch
```

### Related Commands

```
#get_test_patterns
```

## #set\_uo\_scan

Adjusts the underscan / overscan of the output image. The default value is 0. Negative values produce an “underscanned” image. Positive values produce an “overscanned” image.

### Syntax

```
#set_uo_scan param1
```

### Parameters

<i>param1</i>	Amount (%)	[-50 ... 50]
---------------	------------	--------------

### Example

```
#set_uo_scan 10  
UNDER/OVER SCAN SET TO 10%
```

### Related Commands

```
#get_uo_scan
```

## #set\_vert\_active

Sets the vertical active pixels and saves it to the specified preset.

### Syntax

```
#set_vert_active param1 param2
```

### Parameters

<i>param1</i>	Pixels	[0 ... 9999]
<i>param2</i>	Preset	[0 ... 5]

### Example

```
#set_vert_active 720 1
VERTICAL ACTIVE 720 SAVED TO PRESET 2
```

### Related Commands

```
#get_timing_preset
#set_horz_active
#set_horz_back_porch
#set_horz_front_porch
#set_horz_sync_polarity
#set_horz_scan_rate
#set_horz_sync_width
#set_horz_total
#set_pixel_clock
#set_vert_back_porch
#set_vert_front_porch
#set_vert_refresh_rate
#set_vert_sync_polarity
#set_vert_sync_width
#set_vert_total
```

## #set\_vert\_back\_porch

Sets the vertical back porch and saves it to the specified preset.

### Syntax

```
#set_vert_back_porch param1 param2
```

### Parameters

<i>param1</i>	Pixels	[0 ... 9999]
<i>param2</i>	Preset	[0 ... 5]

### Example

```
#set_vert_back_porch 20 1
VERTICAL BACK PORCH 20 SAVED TO PRESET 2
```

### Related Commands

```
#get_timing_preset
#set_horz_active
#set_horz_back_porch
#set_horz_front_porch
#set_horz_sync_polarity
#set_horz_scan_rate
#set_horz_sync_width
#set_horz_total
#set_pixel_clock
#set_vert_active
#set_vert_front_porch
#set_vert_refresh_rate
#set_vert_sync_polarity
#set_vert_sync_width
#set_vert_total
```

## #set\_vert\_front\_porch

Sets the vertical front porch and saves it to the specified preset.

### Syntax

```
#set_vert_front_porch param1 param2
```

### Parameters

<i>param1</i>	Pixels	[0 ... 9999]
<i>param2</i>	Preset	[0 ... 5]

### Example

```
#set_vert_front_porch 5 1
VERTICAL FRONT PORCH 5 SAVED TO PRESET 2
```

### Related Commands

```
#get_timing_preset
#set_horz_active
#set_horz_back_porch
#set_horz_front_porch
#set_horz_sync_polarity
#set_horz_scan_rate
#set_horz_sync_width
#set_horz_total
#set_pixel_clock
#set_vert_active
#set_vert_back_porch
#set_vert_refresh_rate
#set_vert_sync_polarity
#set_vert_sync_width
#set_vert_total
```

## #set\_vert\_refresh\_rate

Sets the vertical refresh rate and saves it to the specified preset. *param1* is a floating-point value and can be specified up to three decimal places.

### Syntax

```
#set_vert_refresh_rate param1 param2
```

### Parameters

<i>param1</i>	Refresh rate	[0.000 ... 9999.000]
<i>param2</i>	Preset	[0 ... 5]

### Example

```
#set_vert_refresh_rate 60 1
VERTICAL REFRESH RATE 60 SAVED TO PRESET 2
```

### Related Commands

```
#get_timing_preset
#set_horz_active
#set_horz_back_porch
#set_horz_front_porch
#set_horz_sync_polarity
#set_horz_scan_rate
#set_horz_sync_width
#set_horz_total
#set_pixel_clock
#set_vert_active
#set_vert_back_porch
#set_vert_front_porch
#set_vert_sync_polarity
#set_vert_sync_width
#set_vert_total
```

## #set\_vert\_sync\_polarity

Sets the vertical sync polarity and saves it to the specified preset.

### Syntax

```
#set_vert_sync_polarity param1 param2
```

### Parameters

*param1*                      Polarity                      [0 ... 1]

param1	Description
0	Negative
1	Positive

*param2*                      Preset                      [0 ... 5]

### Example

```
#set_vert_sync_polarity 1 1
VERTICAL SYNC POLARITY POSITIVE SAVED TO PRESET 2
```

### Related Commands

```
#get_timing_preset
#set_horz_active
#set_horz_back_porch
#set_horz_front_porch
#set_horz_sync_polarity
#set_horz_scan_rate
#set_horz_sync_width
#set_horz_total
#set_pixel_clock
#set_vert_active
#set_vert_back_porch
#set_vert_front_porch
#set_vert_refresh_rate
#set_vert_sync_width
#set_vert_total
```



## #set\_vert\_sync\_width

Sets the vertical sync width and saves it to the specified preset.

### Syntax

```
#set_vert_sync_width param1 param2
```

### Parameters

<i>param1</i>	Sync width	[0 ... 9999]
<i>param2</i>	Preset	[0 ... 5]

### Example

```
#set_vert_refresh_rate 5 1
VERTICAL SYNC WIDTH 5 SAVED TO PRESET 2
```

### Related Commands

```
#get_timing_preset
#set_horz_active
#set_horz_back_porch
#set_horz_front_porch
#set_horz_sync_polarity
#set_horz_scan_rate
#set_horz_sync_width
#set_horz_total
#set_pixel_clock
#set_vert_active
#set_vert_back_porch
#set_vert_front_porch
#set_vert_sync_polarity
#set_vert_refresh_rate
#set_vert_total
```

## #set\_vert\_total

Sets the total number of vertical pixels and saves it to the specified preset.

### Syntax

```
#set_vert_total param1 param2
```

### Parameters

<i>param1</i>	Total pixels	[0 ... 9999]
<i>param2</i>	Preset	[0 ... 5]

### Example

```
#set_vert_total 750 1
VERTICAL TOTAL 750 SAVED TO PRESET 2
```

### Related Commands

```
#get_timing_preset
#set_horz_active
#set_horz_back_porch
#set_horz_front_porch
#set_horz_sync_polarity
#set_horz_scan_rate
#set_horz_sync_width
#set_horz_total
#set_pixel_clock
#set_vert_active
#set_vert_back_porch
#set_vert_front_porch
#set_vert_sync_polarity
#set_vert_refresh_rate
#set_vert_sync_width
```

## #set\_vertical\_mirror

Enables or disables vertical mirroring. When set to *on*, the output image is flipped vertically.

### Syntax

```
#set_vertical_mirror param1
```

### Parameters

*param1* State [0 ... 1]

param1	Description
0	Off
1	On

### Example

```
#set_vertical_mirror 1  
VERTICAL MIRROR SET TO On
```

### Related Commands

```
#get_vertical_mirror  
#get_video_settings  
#set_horizontal_mirror
```

## #set\_vertical\_shift

Adjust the vertical position of the output image.

### Syntax

```
#set_vertical_shift param1
```

### Parameters

<i>param1</i>	Vertical shift	[-100 ... 100]
---------------	----------------	----------------

### Example

```
#set_vertical_shift -10  
VERTICAL SHIFT IS SET TO -10
```

### Related Commands

```
#get_vertical_shift  
#get_video_settings  
#set_horizontal_shift
```





# VGA & Audio to HDMI Scaler/Converter

## 4

## Appendix

Menu System Summary .....	126
Default Settings .....	132
Surface Mounting Instructions .....	133
Specifications .....	134
Index .....	135

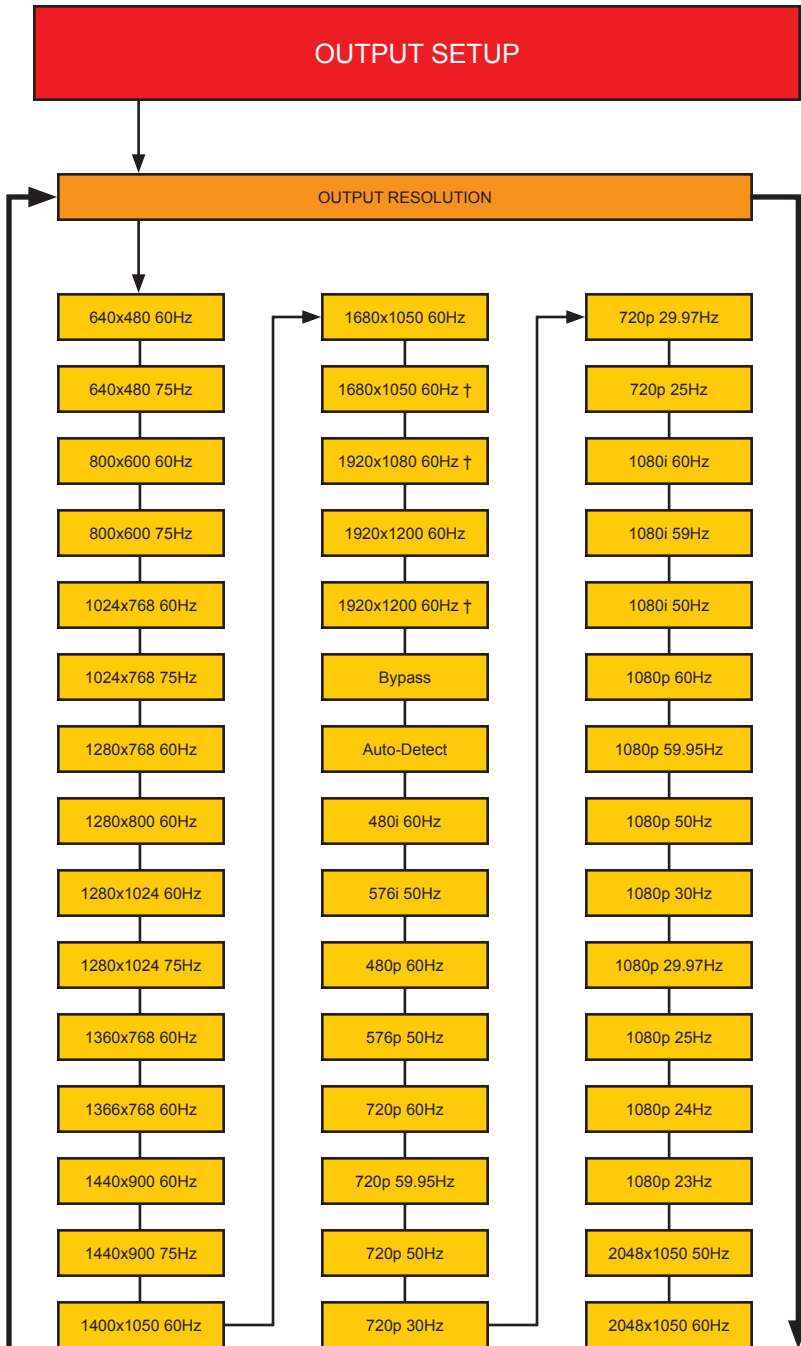



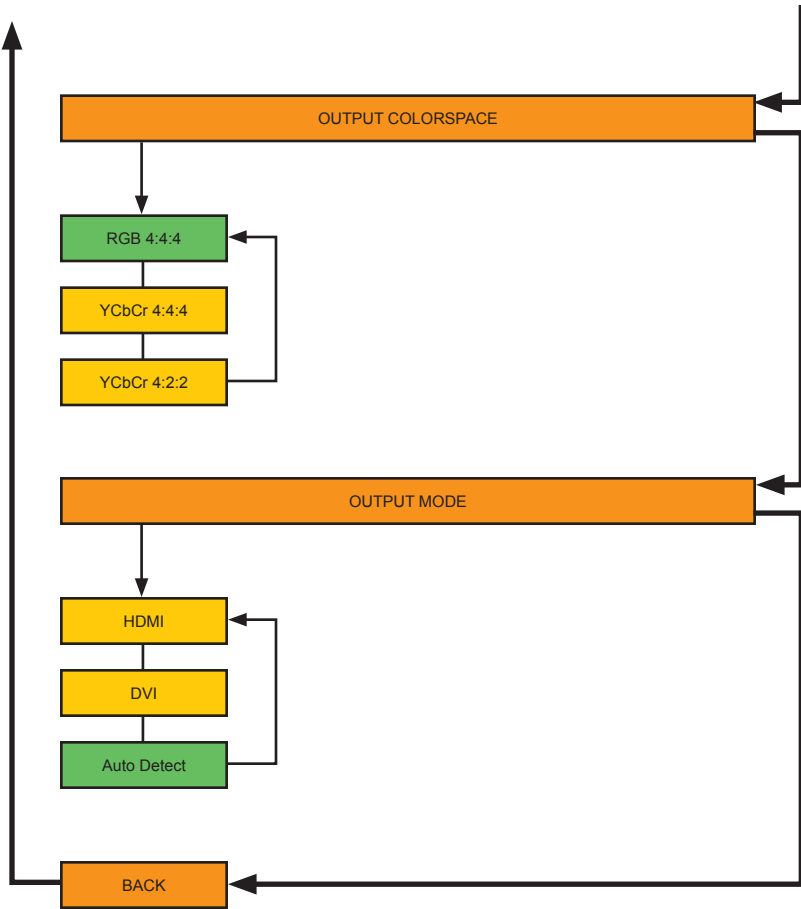

### Information

Note the following frequency information:

23 Hz = 23.98 Hz

29 Hz = 29.97 Hz

59 Hz = 59.94 Hz

† Denotes output resolution that supports reduced blanking.

Boxes in green indicate the default setting.

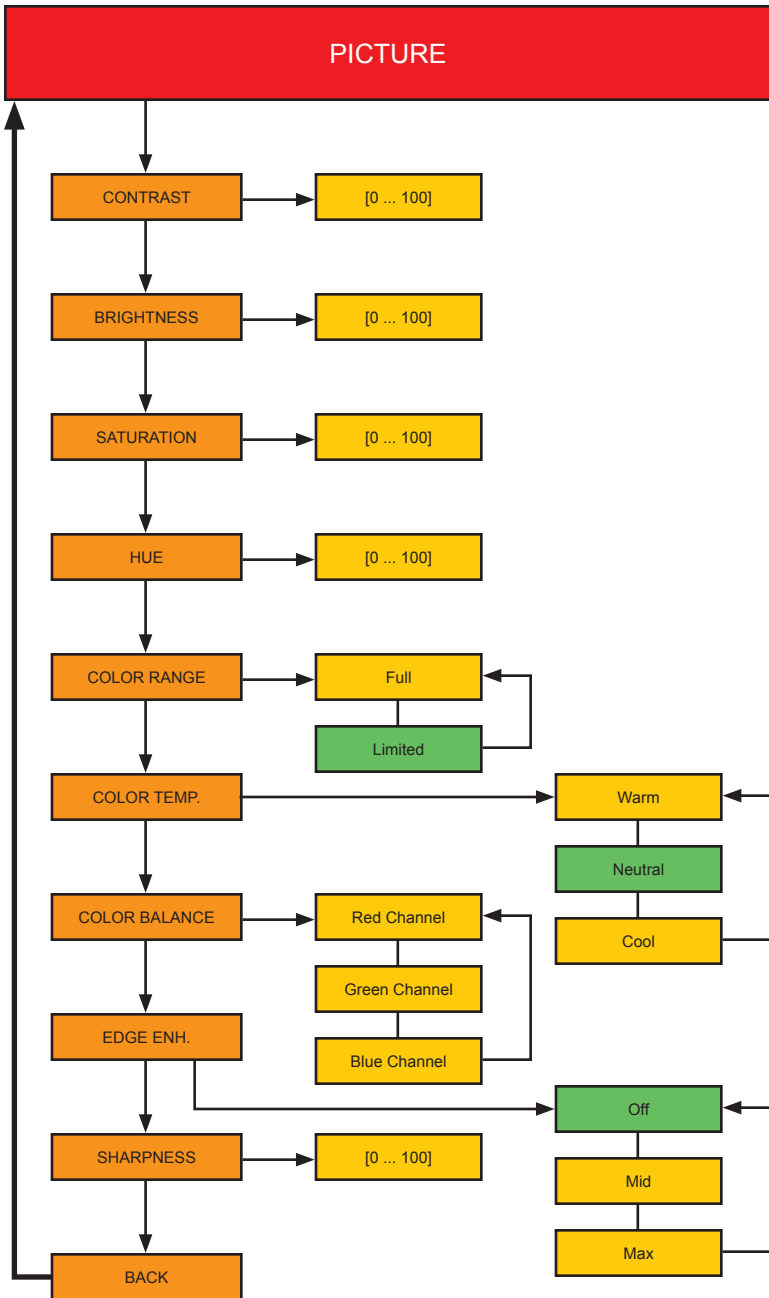

Boxes in green indicate the default setting.

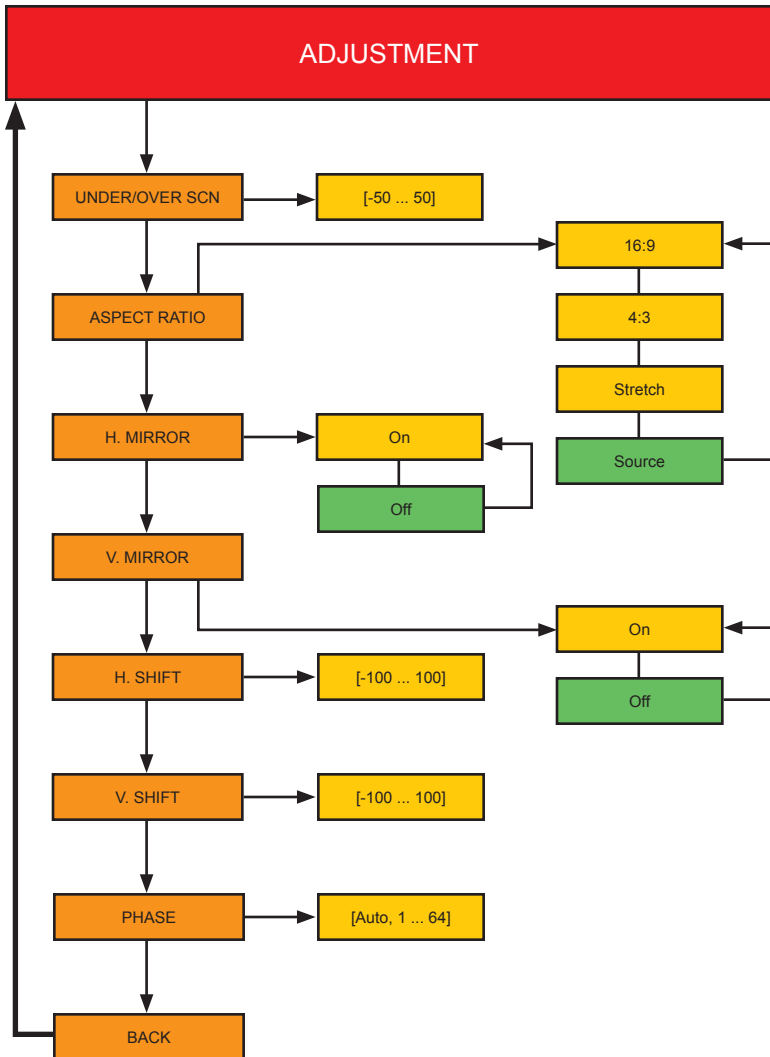

Boxes in green indicate the default setting.

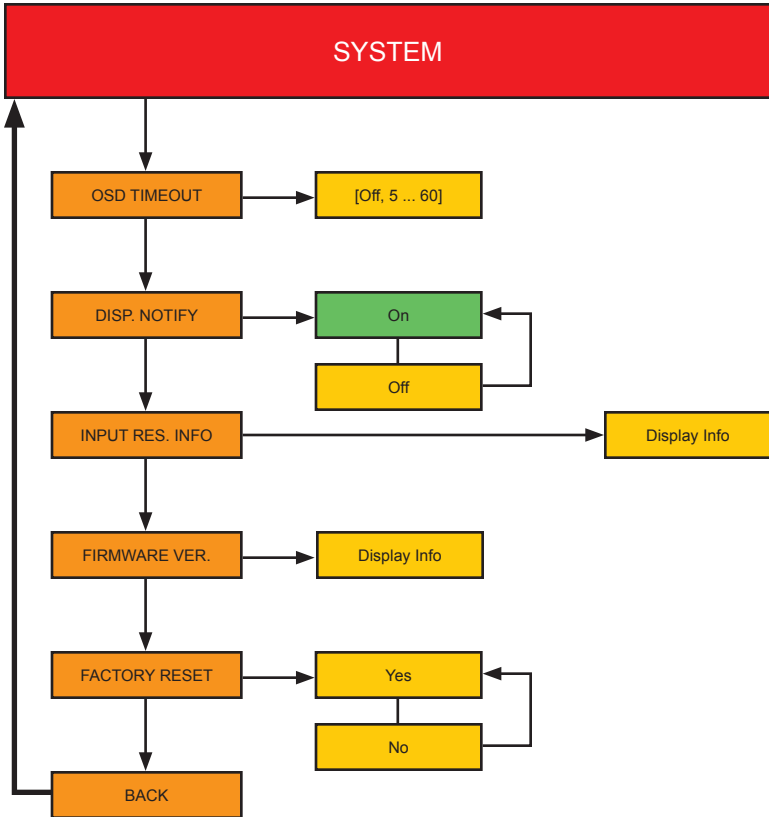

Boxes in green indicate the default setting.

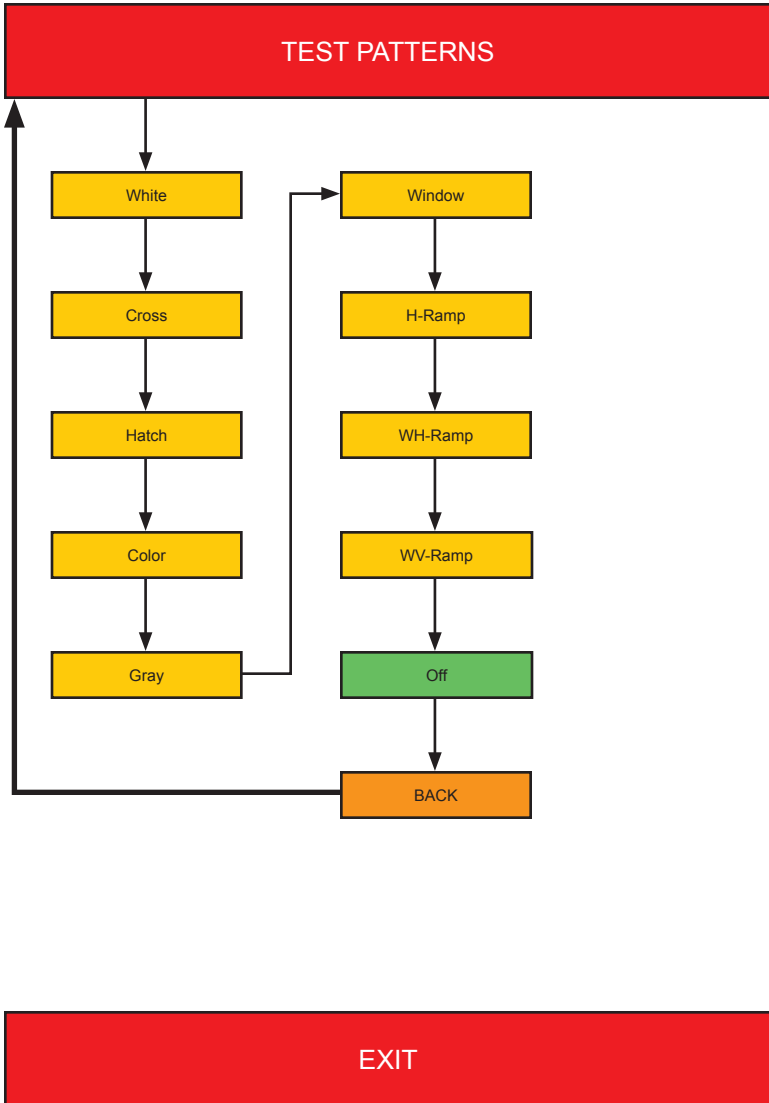

EXIT

Setting	Value
Aspect Ratio	Source
Brightness	50
Color Balance (Blue Channel)	50
Color Balance (Green Channel)	50
Color Balance (Red Channel)	50
Color Range	Limited
Color Temperature	Neutral
Contrast	50
Display Notifications	On
Edge Enhancement	Off
Horizontal Mirror	Off
Horizontal Shift	Off
Hue	50
OSD Timeout	5 seconds
Output Color Space	RGB 4:4:4
Output Mode	Auto-Detect
Output Resolution	Auto-Detect
Phase	Auto
Saturation	50
Sharpness	0
Test Patterns	Off
Under/Over Scan	Off
Vertical Mirror	Off
Vertical Shift	Off

# Surface Mounting Instructions

The Sender and Receiver units can be mounted on any flat surface, as shown below (screws not included). There should be an inch or two of clearance between the edges of the unit and any walls or vertical surfaces to allow for enough clearance for connection and disconnection of the DVI cables.

For installation on a drywall surface, use a #6 drywall screw. When installing, it is recommended to use the center hole on a stud.

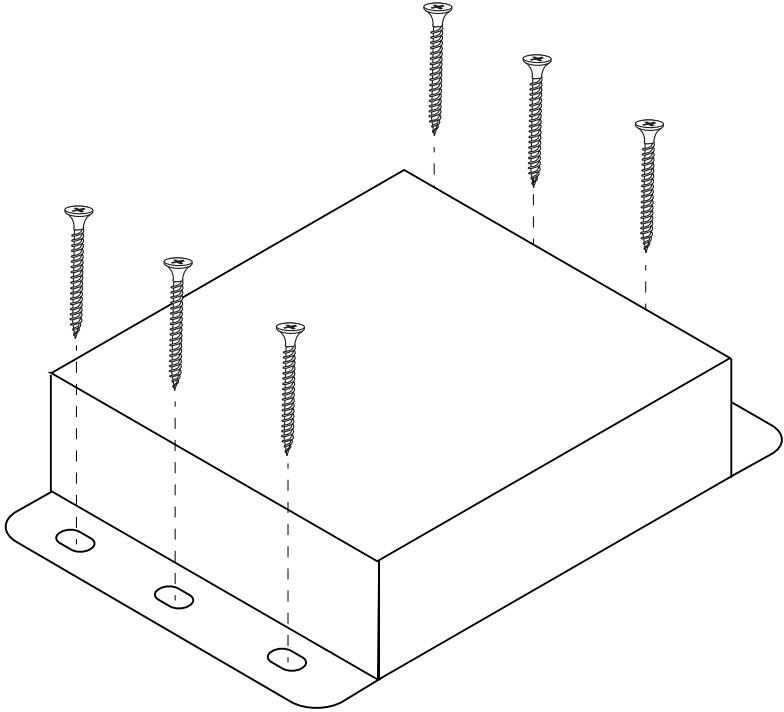

## Connectors, Controls, and Indicators

Video Input	• 1 x VGA HD-15, female
Video Output	• 1 x HDMI Type A 19-pin, female
Audio	• 1 x 3.5mm mini-stereo
USB	• 1 x USB Mini-B, female
Power Receptacle	• 3-pin, locking
Menu	• 1 x push button, tact-type
Up	• 1 x push button, tact-type
Dn	• 1 x push button, tact-type
Power Indicator	• 1 x LED, blue

## Operational

Maximum Pixel Clock	• 165 MHz
Maximum TMDS Clock	• 225 MHz
Power Input	• 12V DC (nominal) 6V to 24V DC operating range
Power Consumption	• 2.6W (max.)
Operating Temperature	• +32 to +122 °F (0 to +50 °C)
Operating Humidity	• 5% to 90% RH, non-condensing
Storage Temperature	• -4 to +185 °F (-20 to +85 °C)
Storage Humidity	• 0% to 95% RH, non-condensing
MTBF	• 50000 Hours

## Physical

Dimensions (W x H x D)	4.9" x 1" x 3.2" (123mm x 26mm x 82mm)
Unit Weight	0.4 lbs. (0.2kg)



**A**

## Active pixels

- horizontal* 95
- vertical* 114

## Aspect ratio 28, 55, 85

## Audio

- Input* 3

**B**

## Back porch

- horizontal* 96
- vertical* 115

## Brightness 19, 56, 86

**C**

## Color

- balance* 24, 87
- range* 22, 88
- saturation* 20, 110
- temperature* 23, 89

## Commands 50

- #factory\_reset* 53
- #fw\_upgrade* 54
- #get\_aspect\_ratio* 55
- #get\_brightness* 56
- #get\_color\_balance* 57
- #get\_color\_range* 57, 58
- #get\_color\_temp* 59
- #get\_contrast* 60
- #get\_display\_notify* 61
- #get\_edge\_enhance* 62
- #get\_firmware\_version* 63
- #get\_horizontal\_mirror* 64
- #get\_horizontal\_shift* 65
- #get\_hue* 66
- #get\_input\_resolution* 67
- #get\_osd\_timeout* 68
- #get\_output\_color* 69
- #get\_output\_mode* 70
- #get\_output\_res* 71, 72
- #get\_phase* 72
- #get\_picture\_settings* 73
- #get\_saturation* 74
- #get\_sharpness* 75
- #get\_test\_patterns* 76
- #get\_timing\_preset* 77

- #get\_uo\_scan* 78
- #get\_vertical\_mirror* 79
- #get\_vertical\_shift* 80
- #get\_video\_output* 80, 81
- #get\_video\_settings* 82
- #help* 83
- #reboot* 84
- #set\_aspect\_ratio* 85
- #set\_brightness* 86
- #set\_color\_balance* 87
- #set\_color\_range* 88
- #set\_color\_temp* 89
- #set\_contrast* 90
- #set\_display\_notify* 91
- #set\_edge\_enhance* 92
- #set\_horizontal\_mirror* 93
- #set\_horizontal\_shift* 94
- #set\_horz\_active* 95
- #set\_horz\_back\_porch* 96
- #set\_horz\_front\_porch* 97
- #set\_horz\_scan\_rate* 98
- #set\_horz\_sync\_polarity* 99
- #set\_horz\_sync\_width* 100
- #set\_horz\_total* 101
- #set\_hue* 102
- #set\_osd\_timeout* 103
- #set\_output\_color* 104
- #set\_output\_mode* 105
- #set\_output\_res* 106, 108
- #set\_phase* 108
- #set\_pixel\_clock* 109
- #set\_saturation* 110
- #set\_sharpness* 111
- #set\_test\_patterns* 112
- #set\_uo\_scan* 113
- #set\_vert\_active* 114
- #set\_vert\_back\_porch* 115
- #set\_vert\_front\_porch* 116
- #set\_vertical\_mirror* 121
- #set\_vertical\_shift* 122
- #set\_vert\_refresh\_rate* 117
- #set\_vert\_sync\_polarity* 118
- #set\_vert\_sync\_width* 119
- #set\_vert\_total* 120

## COM port

- installing* 48

## Contrast 18, 90

**D**

Default settings *132*  
 Display notify *37, 91*

**E**

Edge enhance *25, 92*

**F**

Factory reset. *See* Resetting the unit  
 Features *vi*  
 Firmware  
   *displaying 40*  
 Front porch  
   *horizontal 97*  
   *vertical 116*

**H**

Help *83*  
 Horizontal mirror *29, 93*  
 Horizontal shift *33, 94*  
 Hue *21, 102*

**I**

Input resolution *39*  
 Installation *4*

**M**

Menu system  
   *displaying 8*  
   *summary 126*  
   *using 9*  
 Mirror  
   *horizontal 29, 93*  
   *vertical 31*  
 Mounting Instructions *133*

**O**

Operating Notes *v*  
 OSD timeout *36, 103*  
 Output  
   *color 14, 104*  
   *mode 16, 105*  
   *resolution 12, 106, 108*  
   *video 80, 81*  
 Overscan *27, 113*

**P**

Packing list *vi*  
 Phase *35*  
 Picture settings *73*  
 Pixel  
   *active. See Active pixels*  
   *clock 109*  
   *total*  
     *horizontal 101*  
 Porch  
   *back. See Back porch*  
   *front. See Front porch*

**R**

Rebooting the unit *84*  
 Refresh rate  
   *vertical 117*  
 Resetting the unit *53*  
 Resolution. *See* Output: resolution  
   *input 39, 67*

**S**

Safety Instructions *ii*  
 Saturation. *See* Color: saturation  
 Scan rate  
   *horizontal 98*  
 Settings  
   *video 82*  
 Sharpness *26, 111*  
 Shift  
   *horizontal 33*  
   *vertical 34*  
 Specifications *134*

## Sync

*polarity**horizontal* 99*vertical* 118*width**horizontal* 100*vertical* 119**T**Table of Contents *viii*Technical Support *iv*

Test patterns 42, 112

Timing preset 77

**U**

Underscan 27, 113

Upgrading the firmware 54

USB interface 48

*COM port. See COM port: installing***V**

Vertical mirror 31, 121

Vertical shift 34, 122

Video settings. *See Settings: video***W**Warranty Information *iii*



20600 Nordhoff St., Chatsworth CA 91311  
1-800-545-6900 818-772-9100 fax: 818-772-9120  
[www.gefen.com](http://www.gefen.com) [support@gefen.com](mailto:support@gefen.com)