

Gefen

8x8 DVI Matrix

EXT-DVI-848

User Manual



www.gefen.com

1080P
PROGRESSIVE

HDMI
HIGH DEFINITION MULTIMEDIA INTERFACE

CDTV

HD DVD
RECORDERS

Blu-ray Disc™

ASKING FOR ASSISTANCE

Technical Support:

Telephone (818) 772-9100
(800) 545-6900

Fax (818) 772-9120

Technical Support Hours:

8:00 AM to 5:00 PM Monday thru Friday.

Write To:

Gefen Inc.
c/o Customer Service
20600 Nordhoff St
Chatsworth, CA 91311

www.gefen.com
support@gefen.com

Notice

Gefen Inc. reserves the right to make changes in the hardware, packaging and any accompanying documentation without prior written notice.

8x8 DVI Matrix is a trademark of Gefen Inc.

CONTENTS

- 1 Introduction
- 2 Operation Notes
- 3 Features
- 4 8x8 DVI Matrix Front Panel Layout
- 5 8x8 DVI Matrix Front Panel Descriptions
- 6 8x8 DVI Matrix Back Panel Layout
- 7 8x8 DVI Matrix Back Panel Descriptions
- 8 EXT-RMT-Matrix-848 Panel Layout
- 9 EXT-RMT-Matrix-848 Panel Descriptions
- 10 Connecting And Operating The 8x8 DVI Matrix
- 11 8x8 DVI Matrix Remote Description & Operation
- 12 RMT-848IR IR Channel Configuration
- 13 EXT-RMT-Matrix-848 Remote Operation
- 14 RMT-8-IR IR Channel Configuration
- 15 RS-232 Serial Control Interface
- 16 Network Cable Wiring Diagram
- 17 Appendix A
- 19 Appendix B
- 24 Specifications
- 25 Warranty

INTRODUCTION

Congratulations on your purchase of the 8x8 DVI Matrix. Your complete satisfaction is very important to us.

Gefen

Gefen delivers innovative, progressive computer and electronics add-on solutions that harness integration, extension, distribution and conversion technologies. Gefen's reliable, plug-and-play products supplement cross-platform computer systems, professional audio/video environments and HDTV systems of all sizes with hard-working solutions that are easy to implement and simple to operate.

The Gefen 8x8 DVI Matrix

Now you can easily combine eight cross-platform computers and eight digital displays without networking. Our 8x8 DVI Matrix provides a simple, reliable and highly effective method of creating multiple computer workstations, with each workstation capable of accessing any one of the computers or sources at any time by remote control. You also have the option of setting up the eight stations locally or extending them with a Gefen extender.

How It Works

The 8x8 Matrix has eight DVI inputs and eight DVI outputs. You simply connect your eight computer DVI ports to the 8x8 Matrix inputs, then connect your eight DVI displays to the 8x8 Matrix outputs.

OPERATION NOTES

READ THESE NOTES BEFORE INSTALLING OR OPERATING THE 8X8 DVI MATRIX

- The 8x8 DVI Matrix is not HDCP compliant
- By default, EDID routing is based on the first connected display to a source.

For example, if monitor A is the first display to connect to source 1 its EDID will be used. All other displays that connect to source 1 thereafter will have its EDID ignored. If display 1 switches to another source a hot-plug will be sent and the EDID from the next display that is connected, in numerical order, will be used.

- The Status Output display will only list the current display/source routing.
- There is no internal scaling in the 8x8 DVI Matrix. All of the attached monitors must be able to display the resolutions output by the source devices. For maximum compatibility it is recommended that only one compatible/common resolution be used by all of the source devices.

FEATURES

Features

- Increases your productivity by providing you with access to eight computers from eight workstations
- Maintains beautiful, sharp HDTV resolutions up to 1080p, 2K, and 1920x1200
- Discrete IR remote control included
- Long-distance remote control at distances of up to 330 feet using optional wired CAT5 cabled remotes
- Serial RS232 port for remote control via computer or a control automation device such as Crestron
- Supports DDWG standards for DVI monitors
- Not HDCP compliant; for computer use only.

Package Includes

- (1) 8x8 DVI Matrix
- (1) RMT-848IR IR Remote Control
- (1) 24V DC Power Supply
- (8) 6-foot DVI cables
- (1) Rack Ears
- (1) User's Manual

8X8 DVI MATRIX FRONT PANEL LAYOUT



8X8 DVI MATRIX FRONT PANEL DESCRIPTIONS

1 **LED Status Display**

This display will list the current display/source routes.

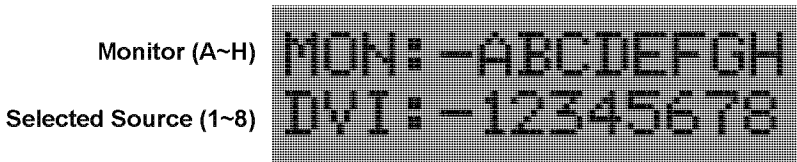

Monitor Output's are labeled 1 through 8 on the rear panel of the 8x8 DVI Matrix. These numbers correspond to the letters A through H on the LED Status Display. The top row of letters will remain static while each input number below will represent which source each of the displays are currently viewing.

2 **IR Receiver**

Use the included RMT-848IR remote control to route video to the different displays.

3 **Power LED Indicator**

This input indicator will become active once the included 24V DC power adapter has been properly connected.

8X8 DVI MATRIX BACK PANEL LAYOUT

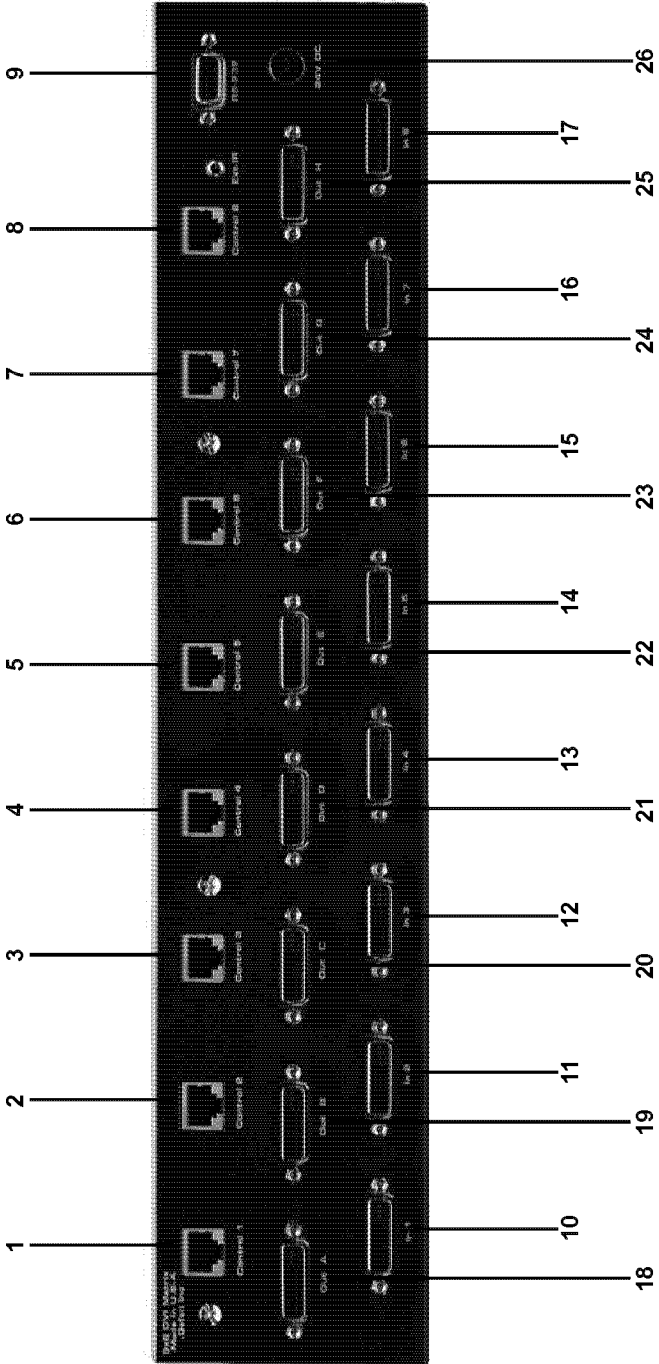

8X8 DVI MATRIX BACK PANEL DESCRIPTIONS

1-8 ***Optional Remote Switching Ports***

Ports 1 through 8 are used for remote switching using the optional component EXT-RMT-MATRIX-848.

9 ***RS-232 Serial Control Interface***

This port is used for serial communication for multiple functions. Access to certain features are only through the RS-232 interface.

10-17 ***DVI Input Ports***

Connect up to 8 DVI sources to DVI Input Ports 1 through 8.

18-25 ***DVI Output Ports***

Connect up to 8 DVI displays to DVI Output Ports 1 through 8. These output ports correspond to Monitors **A** through **H** on the LED Status Display.

26 ***24V DC Power Input***

Connect the included 24V DC power supply to this input.

EXT-RMT-MATRIX-848 PANEL LAYOUT

Front Panel

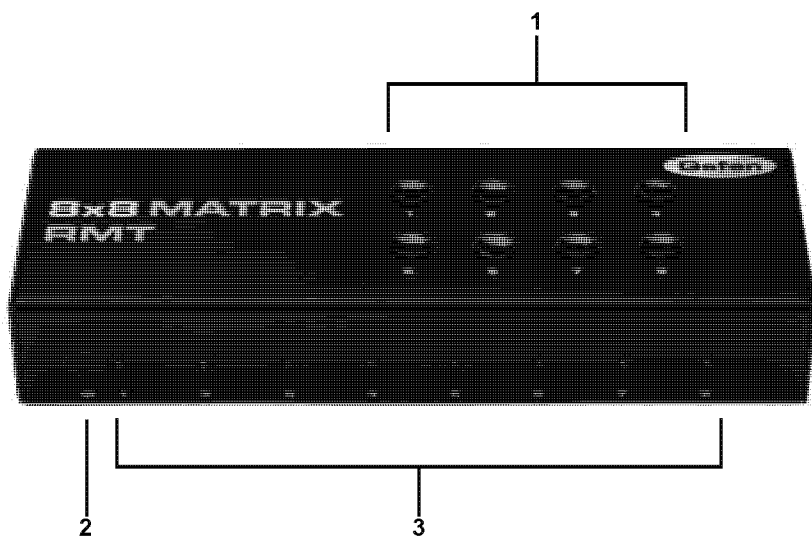

Back Panel

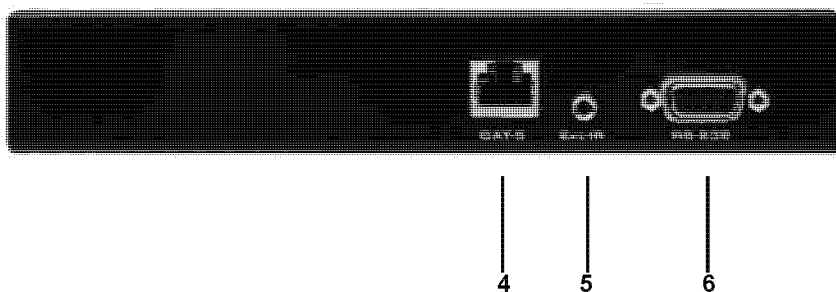

(PRODUCT SOLD SEPARATELY)

EXT-RMT-MATRIX-848 PANEL DESCRIPTIONS

1 Direct Select Buttons

When this unit is attached to a CAT-5 port that corresponds to a display on the 8x8 DVI Matrix, use buttons 1 through 8 to select what source that display will be viewing. Buttons 1 through 8 directly correspond to DVI source inputs 1 through 8 on the 8x8 DVI Matrix.

2 IR Receiver

This port will receive commands from an RMT-8-IR remote control for remote controlled switching at the extended location.

3 Active Input LED Indicator

1 through 8 LED indicators that will visually acknowledge which source is currently selected.

4 CAT-5 Input Port

Connect a CAT-5 cable between this port and the CAT-5 remote switching ports (Item 1 through 8 on page 6) for remote switching.

5 IR Extension Eye

Connect the optional IR Receiver Extension (part# EXT-RMT-EXTIR) to this port.

6 RS-232 Serial Control Port

This port can be used to control switching via RS-232 serial communication.

CONNECTING AND OPERATING THE 8X8 DVI MATRIX

How to Connect the 8x8 DVI Matrix

1. Connect up to 8 DVI sources to the DVI Input ports on the 8x8 DVI Matrix using the supplied DVI cables.
2. Connect up to 8 DVI displays to the DVI Output ports on the 8x8 DVI Matrix using user supplied DVI cables.
3. Optionally connect up to 8 remote switching units (Part# EXT-RMT-MATRIX-848) to the RJ-45 Input ports on the rear panel on the 8x8 DVI Matrix using user supplied CAT-5, CAT-5e or CAT-6.

NOTE: Maximum extension of the EXT-RMT-MATRIX-848 units are 330 Feet (100 Meters).

Operating the 8x8 DVI Matrix

There are 2 main ways to control the 8x8 DVI Matrix. Local and remote control. Local control is done using the included RMT-848IR remote control. Remote control is done using the optional EXT-RMT-MATRIX-848 switching units.

Local Control

To control the unit locally, please use the included RMT-848IR remote control. Please see page 12 for usage information.

Remote control

To control the unit remotely, please use the EXT-RMT-MATRIX-848 remote switcher. Each remote switcher has 8 direct select push-buttons that correspond to DVI inputs 1 through 8. Press the push-button corresponding to the desired source for viewing. There is also the option to use RS-232 switching via the RS-232 port located on the rear panel of the EXT-RMT-MATRIX-848.

8X8 DVI MATRIX REMOTE DESCRIPTION & OPERATION

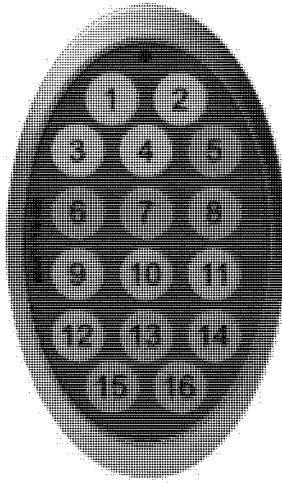

Buttons 1 through 8 on the RMT-16 IR remote control correspond to display outputs A through H. Buttons 9 through 16 correspond to source inputs 1 through 8. Please use the steps and chart below for instructions on how to route video sources to displays.

Output		Input	
Remote Button	Display	Remote Button	Source
1	A	9	1
2	B	10	2
3	C	11	3
4	D	12	4
5	E	13	5
6	F	14	6
7	G	15	7
8	H	16	8

Routing video to a particular display using the remote control is a 2 step process. The first input step is to select the display (Output column). The second input step is to select the source (Input column) that will be routed to the display that was chosen in the first step. The example below shows how to route input source number 7 to display C.

1. Press the remote button labeled 3 (display C) on the RMT-16 IR remote control.
2. Press the remote button labeled 15 (source 7) on the RMT-16 IR remote control.
3. The video from DVI Input 7 should now appear on the display connected to monitor output C.

Repeat these steps to route any video source to any display.

RMT-848IR IR CHANNEL CONFIGURATION

The RMT-848IR remote control has 4 discrete channels for use if the default IR code set conflicts with other remote control commands in your setup. There are 2 DIP Switches underneath the battery on the RMT-848IR remote control. These DIP Switches must match the IR channel in use on the 8x8 DVI Matrix. The underside of the 8x8 DVI has multiple banks of DIP Switches. Please see the diagram of the 8x8 DVI Matrix below for the correct bank and DIP Switches that are used for IR channel configuration. Information on the remaining DIP Switch banks can be found in Appendix A. See below for DIP Switch configurations for each of the available remote channels.

8x8 DVI Matrix DIP Switches

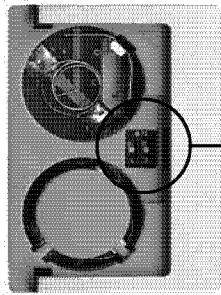
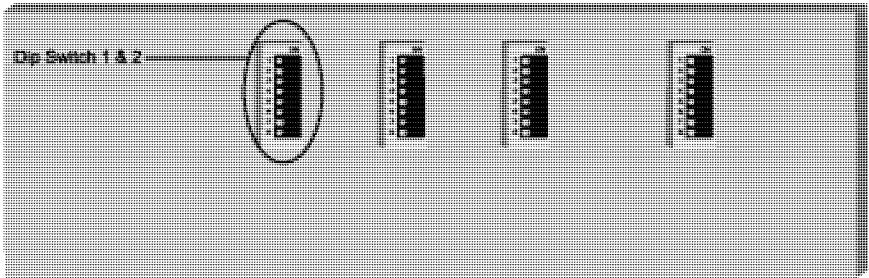

RMT-848IR DIP Switches

IR CHANNEL CONFIGURATION

RMT-848IR REMOTE CONTROL

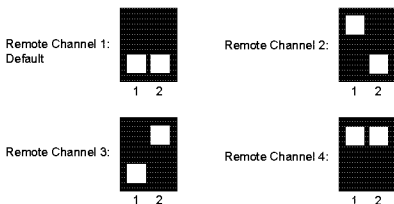

8x8 DVI Matrix

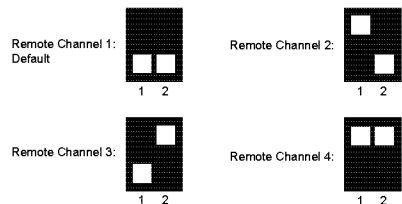

EXT-RMT-MATRIX-848 REMOTE OPERATION



(PRODUCT SOLD SEPARATELY)

Once the EXT-RMT-MATRIX-848 Remote is installed and connected to a remote output port on the 8x8 DVI Matrix, use the direct selection buttons to chose a source to view. Once a source is chosen, its corresponding LED should become active. Optionally, switching can be done using an RMT-8-IR remote control (sold separately) or through the RS-232 serial communications port on the rear panel.

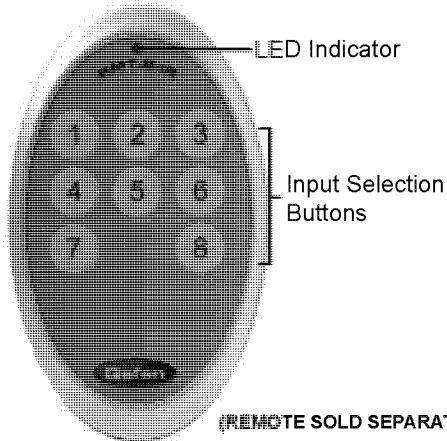

(REMOTE SOLD SEPARATELY)

The RMT-8-IR remote control can be used to select the source that will be displayed on the monitor connected to the EXT-RMT-MATRIX-848.

RMT-8-IR Button	DVI Source
1	1
2	2
3	3
4	4
5	5
6	6
7	7
8	8

RMT-8-IR IR CHANNEL CONFIGURATION

The RMT-8-IR remote control (sold separately) has 4 discrete IR channels for use if the default IR code set conflicts with other remote control commands in your setup. There are 2 DIP Switches underneath the battery on the RMT-8-IR remote control that must match DIP Switches on the EXT-RMT-MATRIX-848. There are 4 DIP Switches located on the underside of the EXT-RMT-MATRIX-848. DIP Switches 1 and 2 on the EXT-RMT-MATRIX-848 correspond to DIP Switches 1 and 2 on the RMT-8-IR remote control. See below for DIP Switch configuration of each of the available remote channels.

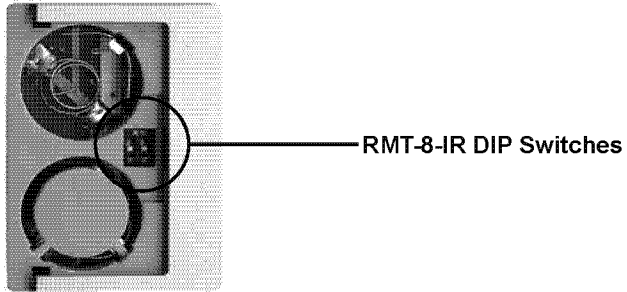

RMT-8-IR REMOTE CONTROL

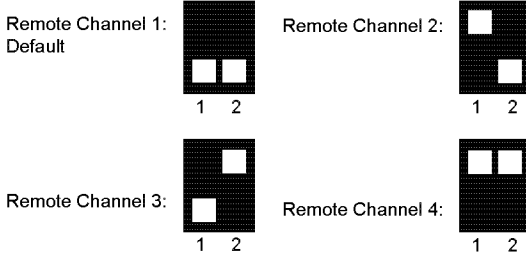

EXT-RMT-MATRIX-848

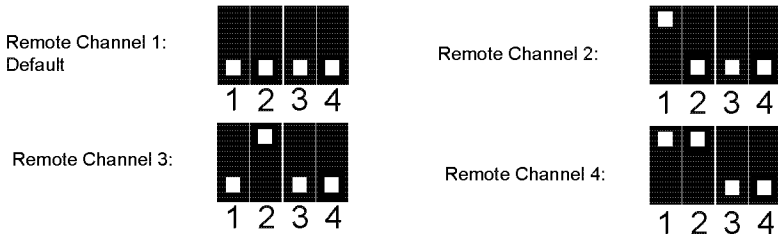

RS-232 SERIAL CONTROL INTERFACE

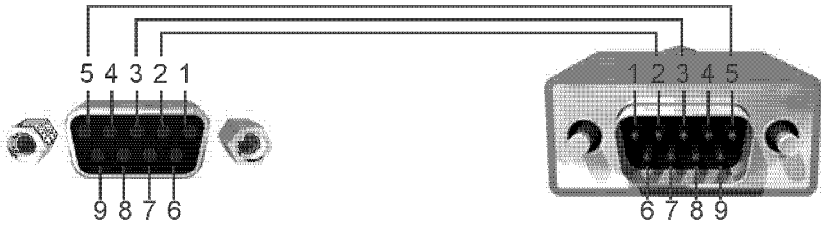

Only Pins 2 (RX), 3 (TX), and 5 (Ground) are used on the RS-232 serial interface

RS232 Settings

Bits per second 19200

Data bits 8

Parity None

Stop bits 1

Flow Control None

Please see Appendix B for information on the available RS-232 commands.

NETWORK CABLE WIRING DIAGRAM

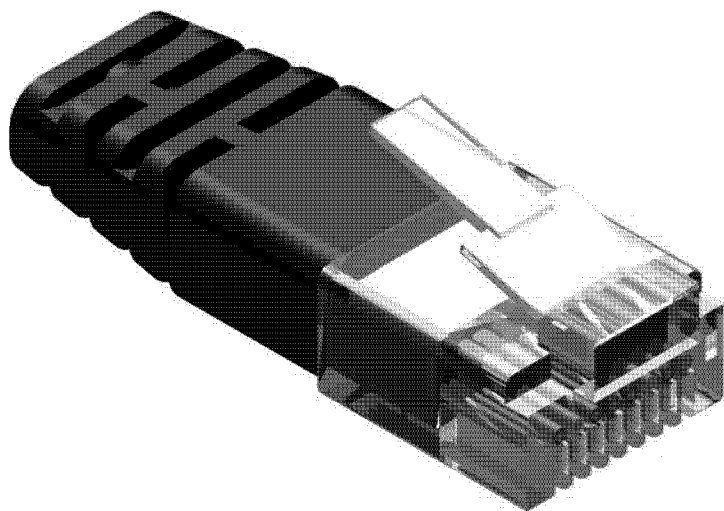

Gefen has specifically engineered their products to work with the TIA/EIA-568-B specification. Please adhere to the table below when field terminating cable for use with Gefen products. Failure to do so may produce unexpected results and reduced performance.

Pin	Color
1	Orange / White
2	Orange
3	Green / White
4	Blue
5	Blue / White
6	Green
7	Brown / White
8	Brown

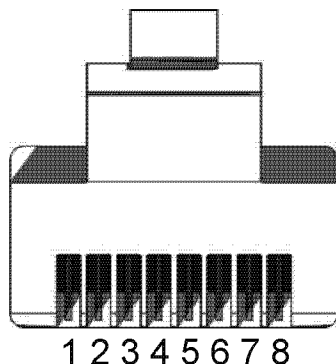

CAT-5, CAT-5e, and CAT-6 cabling comes in stranded and solid core types. Gefen recommends using solid core cabling. CAT-6 cable is also recommended for best results.

Each cable run must be one continuous run from one end to the other. No splices or use of punch down blocks.

APPENDIX A

The 8X8 DVI Matrix has 4 banks of DIP Switches located on the underside of the main unit. This section will outline the function of each DIP Switch bank.

DIP SWITCH BANKS

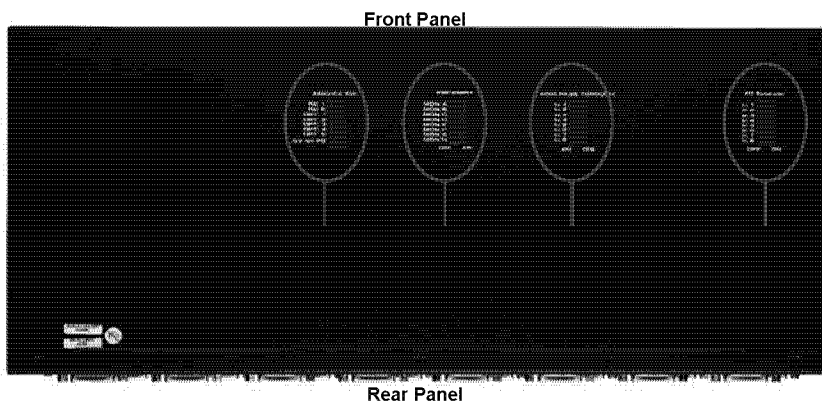

DIP Switch Bank	Description
A	<ul style="list-style-type: none"> • RMT-848IR channel configuration
B	<ul style="list-style-type: none"> • Monitor pre-emphasis
C	<ul style="list-style-type: none"> • For future implementation
D	<ul style="list-style-type: none"> • For future implementation

DIP SWITCH BANK A

DIP Switch	Description
1	RMT-848IR remote control channel configuration. This setting must match DIP Switch 1 on the RMT-848IR remote control.
2	RMT-848IR remote control channel configuration. This setting must match DIP Switch 2 on the RMT-848IR remote control.
3	NOT USED
4	NOT USED
5	NOT USED
6	NOT USED
7	NOT USED
8	For future implementation

APPENDIX A

DIP SWITCH BANK B

DIP Switch	Monitor	Description
1	A	[OFF] 0 db pre-emphasis, [ON] 6 db pre-emphasis
2	B	[OFF] 0 db pre-emphasis, [ON] 6 db pre-emphasis
3	C	[OFF] 0 db pre-emphasis, [ON] 6 db pre-emphasis
4	D	[OFF] 0 db pre-emphasis, [ON] 6 db pre-emphasis
5	E	[OFF] 0 db pre-emphasis, [ON] 6 db pre-emphasis
6	F	[OFF] 0 db pre-emphasis, [ON] 6 db pre-emphasis
7	G	[OFF] 0 db pre-emphasis, [ON] 6 db pre-emphasis
8	H	[OFF] 0 db pre-emphasis, [ON] 6 db pre-emphasis

DIP SWITCH BANK C

DIP Switch	Input	Description
1	1	For future implementation
2	2	For future implementation
3	3	For future implementation
4	4	For future implementation
5	5	For future implementation
6	6	For future implementation
7	7	For future implementation
8	8	For future implementation

DIP SWITCH BANK D

DIP Switch	Monitor	Description
1	1	For future implementation
2	2	For future implementation
3	3	For future implementation
4	4	For future implementation
5	5	For future implementation
6	6	For future implementation
7	7	For future implementation
8	8	For future implementation

APPENDIX B

The 8X8 DVI Matrix uses RS-232 serial communication for access to a number of features. Please us this section for EDID storing, calling, and routing functions.

REMOTE FUNCTION

The remote functions are used to modify the setting of the product, such as: Input to output routing, EDID memory management etc. These functions are available only by the serial communications port.

Modify By Shortcut

Switching Command

First character indicates the output monitor. Second character indicates the input number.

Example: 'A5' routes input 5 to output monitor A

Matrix Status Command

The 'M' or 'm' command will return the current routing state.

Shortcut Routing Command

This command sets the matrix routing state according to a preset routing state. First character is 'S' or 's', second character indicates the state that is set by

function #PSASRS or #MSASRS (please see page##)

Setting Function Menu

The 'P' or 'p' command will return the settings function menu.

Modify By Function

The syntax for each function is always the same. The '#' character is the start flag followed by the function name in capital letter and a space. The space tells the MCU that the function name is ending. Finally, the parameters required for each function are separated by a space and ending by the '\r' character or "Enter"

Example: #FunctionName_param1_param2_param3_param4...\r

RMT-848IR Address

This function set the remote channel that must match the GEFEN RMT-848IR remote control.

#RMT_param1\r

Parameter	Value
1	[0:3]

APPENDIX B

DS EDID Store In Locals Edid

This function reads EDID file from DS and store it in any input Locals EDID.

```
#EDIDDSTOLO_param1_param2[_param3][_param4][_param5] [_param6]  
[_param7][_param8][_param9]r
```

Parameter	Name	Value
1	MONITOR	[A:H]
2 (3-9 optionally)	INPUT	[1:8]

DS EDID Store In EDID Bank

This function reads EDID file from DS and store it in EDID bank.

```
#EDIDDSTOBA_param1_param2r
```

Parameter	Name	Value
1	MONITOR	[A:H]
2	EDID bank offset	[1:7]

EDID From Bank Store In Locals EDID

This function reads an EDID file from the EDID bank and stores it in any Input's local EDID.

```
#EDIDBATOLO_param1_param2[_param3][_param4][_param5][_param6]  
[_param7][_param8][_param9]r
```

Parameter	Name	Value
1	EDID bank offset	[1:7]
2 (3-9 optionally)	INPUT	[1:8]

APPENDIX B

Route Input DDC To Local EDID

This function routes the Input DDC to the Local EDID.

#DDCTOLO_param1r

Parameter	Name	Value
1	INPUT	[1:8]

Print DS EDID

This function reads the DS EDID file and sends it to the serial port.

#PRDSEDID_param1_param2r

Parameter	Name	Value
1	MONITOR	[A:H]
2	Send BIN file	0
	Send TXT file	1

Print Local EDID

This function reads the Input Local EDID file and sends it to the serial port.

#PRLOEDID_param1_param2r

Parameter	Name	Value
1	INPUT	[1:8]
2	Send BIN file	0
	Send TXT file	1

Print EDID Bank

This function reads the EDID file from the EDID bank and send it to the serial port.

#PRBAEDID_param1_param2r

Parameter	Name	Value
1	EDID bank offset	[1:7]
2	Send BIN file	0
	Send TXT file	1

APPENDIX B

Print EDID Setting

This function sends the EDID setting table to the serial port.

```
#PRSEEDIDr
```

Load EDID To Locals EDID

These functions will load an EDID file through the serial port and store it in any Input's Local EDID.

```
#LOEDIDTOLO_param1_param2_param3[_param4][_param5][_param6]  
[_param7][_param8][_param9][_param10]r
```

Parameter	Name	Value
1	Semi echo mode	0
	Full echo mode	1
2	EDID.bin file (256 bytes)	1
	EDID.bin file (256 bytes)	2
3 (4-10 optionally)	INPUT	[1:8]

Load EDID To EDID Bank

This function loads an EDID through the serial port and store it in the EDID bank.

```
#LOEDIDTOBA_param1_param2r
```

Parameter	Name	Value
1	Semi echo mode	0
	Full echo mode	1
2	EDID.bin file (256 bytes)	1
	EDID.bin file (256 bytes)	2
3	EDID bank offset	[1:7]

Set Output Pre Emphasis

This function will set output Pre Emphasis in db.

```
#PE_param1_param2r
```

Parameter	Name	Value
1	MONITOR	[A:H]
2	Pre Emp level [db]	[0,2,4,6]

APPENDIX B

Set Default Setting

This function will set the product back to its default setting.

1. Routing state will be INPUT1-MONA, INPUT2-MONB, ...,
2. All the features with default to how the hardware switches are set.

#DEF\r

Set Preset Routing State

This function enables the user to determine up to 10 routing states to save in memory.

#PSASRS_param1_param2_param3_param4_param5_param6_param7_
param8_param9\r

Parameter	Name	Value
1	Routing state	[0:9]
2	Input route to MONITOR A	[1:8]
3	Input route to MONITOR B	[1:8]
4	Input route to MONITOR C	[1:8]
5	Input route to MONITOR D	[1:8]
6	Input route to MONITOR E	[1:8]
7	Input route to MONITOR F	[1:8]
8	Input route to MONITOR G	[1:8]
9	Input route to MONITOR H	[1:8]

Set Current Matrix As Routing State

#MSASRS_param1\r

Parameter	Name	Value
1	Routing state	[0:9]

Print Routing State Table

#PRRS\r

SPECIFICATIONS

Video Amplifier Bandwidth	165 MHz per channel
Single Link Range	1080p (HDTV) / 1920x1200 (PC)
Input Video Signal	1.2 Volts p-p
Input DDC Signal	5 Volts p-p (TTL)
Remote Control Ports	One RS232 female, One mini-stereo
Rack mountable	2U rack space, rack ears included
DVI Connector	DVI-I 29 Pin Female (digital only)
Power Supply	24V DC
Power Consumption	60 Watts (max)