



CPLUS-V11PI

4K UHD+ HDMI Audio Inserter



Operation Manual

DISCLAIMERS

The information in this manual has been carefully checked and is believed to be accurate. Cypress Technology assumes no responsibility for any infringements of patents or other rights of third parties which may result from its use.

Cypress Technology assumes no responsibility for any inaccuracies that may be contained in this document. Cypress also makes no commitment to update or to keep current the information contained in this document.

Cypress Technology reserves the right to make improvements to this document and/or product at any time and without notice.

COPYRIGHT NOTICE

No part of this document may be reproduced, transmitted, transcribed, stored in a retrieval system, or any of its part translated into any language or computer file, in any form or by any means—electronic, mechanical, magnetic, optical, chemical, manual, or otherwise—without express written permission and consent from Cypress Technology.

© Copyright 2018 by Cypress Technology.

All Rights Reserved.

TRADEMARK ACKNOWLEDGMENTS

All products or service names mentioned in this document may be trademarks of the companies with which they are associated.





SAFETY PRECAUTIONS

Please read all instructions before attempting to unpack, install or operate this equipment and before connecting the power supply.

Please keep the following in mind as you unpack and install this equipment:

- Always follow basic safety precautions to reduce the risk of fire, electrical shock and injury to persons.
- To prevent fire or shock hazard, do not expose the unit to rain, moisture or install this product near water.
- Never spill liquid of any kind on or into this product.
- Never push an object of any kind into this product through any openings or empty slots in the unit, as you may damage parts inside the unit.
- Do not attach the power supply cabling to building surfaces.
- Use only the supplied power supply unit (PSU). Do not use the PSU if it is damaged.
- Do not allow anything to rest on the power cabling or allow any weight to be placed upon it or any person walk on it.
- To protect the unit from overheating, do not block any vents or openings in the unit housing that provide ventilation and allow for sufficient space for air to circulate around the unit.

REVISION HISTORY

VERSION NO.	DATE	SUMMARY OF CHANGE
RDV1	25/11/16	Preliminary release
VS1	12/02/18	Final technical review



CONTENTS

1. Introduction	1
2. Applications	1
3. Package Contents	1
4. System Requirements	1
5. Features	2
6. Operation Controls and Functions	3
6.1 Front Panel.....	3
6.2 Rear Panel.....	4
6.3 Virtual COM Port Control	4
6.4 EDID Commander.....	6
6.4.1 EDID Controller Tab.....	7
6.4.2 EDID Creator Tab	8
6.4.3 System Tab.....	9
7. Connection Diagram	10
8. Specifications	11
8.1 Technical Specifications	11
8.2 Video Specifications.....	12
8.3 Audio Specifications.....	13
9. Acronyms	14





1. INTRODUCTION

This HDMI Audio Inserter is designed to insert an external audio signal (analog or digital) into any HDMI or DVI source signal to generate an HDMI compliant output with new audio. Both stereo LPCM 2.0 and multi-channel Bitstream audio is supported for insertion and the preferred source can be selected with a simple switch.

Both the input and output HDMI ports support 4K UHD resolutions up to 4K@60Hz (4:4:4, 8-bit) and are capable of providing high quality audio and video performance. This unit supports passthrough of HD and standard Bitstream formats as well as LPCM 7.1 with audio sampling rates up to 192kHz. Built-in EDID management support allows the user select from multiple EDIDs and, with the use of optional PC software, to upload, download, or edit EDID files.

2. APPLICATIONS

- Combines external audio and DVI video (via DVI to HDMI adaptor) to be output as an HDMI signal
- Replaces audio in the original HDMI signal with an external audio source
- AV system integration and home theater installation
- HDMI/DVI EDID management

3. PACKAGE CONTENTS

- 1×HDMI Audio Inserter
- 1×5V/2.6A DC Power Adapter
- 1×Operation Manual

4. SYSTEM REQUIREMENTS

- HDMI source equipment such as a media player, video game console or set-top box.
- HDMI receiving equipment such as an HDTV, monitor or audio amplifier.
- The use of “Premium High Speed HDMI” cables is highly recommended.

5. FEATURES

- HDMI input and output with 18Gbps (600MHz) 4K UHD support
- DVI 1.0 compatible with the use of an HDMI-DVI adaptor
- HDCP 1.4 and 2.2 compliant
- Supports HD resolutions up to 3840×2160@60 Hz (4:4:4, 8-bit) & 4096×2160@60 Hz (4:4:4, 8-bit)
- Supports 48-bit Deep Color up to 1080p@60Hz
- Supports passthrough of LPCM 7.1, Bitstream and HD Bitstream audio formats over HDMI
- Supports embedding external audio sources (analog stereo or digital S/PDIF) into an existing HDMI source, or adding audio to a DVI source (output as HDMI)
- Supports HDMI audio sampling rates up to 192kHz
- Supports the following S/PDIF audio sampling rates: 32kHz, 44.1kHz, 48kHz, 88.2kHz, 96kHz, 192kHz
- Provides EDID management with EDID bypass and 2 user modifiable EDIDs
- PC based EDID management tool support
- Outputs a 720p60 color bar pattern when no input is connected
- Supports RS-232 style control via a Virtual COM port over USB

6. OPERATION CONTROLS AND FUNCTIONS

6.1 Front Panel

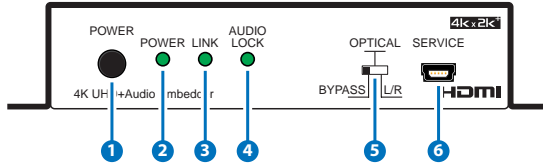

- 1 POWER:** Press this button to power the unit on or off.
- 2 POWER:** This LED will be lit when the unit is receiving power.
Note: Press and hold the Power button for 3 seconds (until the LEDs begin flashing) to perform a factory reset.
- 3 LINK:** This LED will illuminate to indicate that a live source has been detected on the input port. When no source is detected the LED will remain off.
- 4 AUDIO LOCK:** The LED will illuminate when a live non-LPCM source (typically Bitstream) has been detected.
Note: When this LED is lit, please ensure that the connected HDMI display device supports the Bitstream audio format being inserted.
- 5 BYPASS/OPTICAL & L/R:** This switch selects the source of the audio to be embedded in the HDMI output. "BYPASS" passes the audio directly from the HDMI input to the HDMI output without modification. "OPTICAL" embeds the audio from the optical S/PDIF audio input (LPCM 2.0 or Bitstream). "L/R" embeds the audio from the analog stereo inputs (LPCM 2.0 only).
- 6 SERVICE:** This slot is for EDID management, control and firmware update use. Connect directly to your PC/laptop using a standard Mini-USB cable to connect using the PC software or to send commands (via virtual COM port).

6.2 Rear Panel

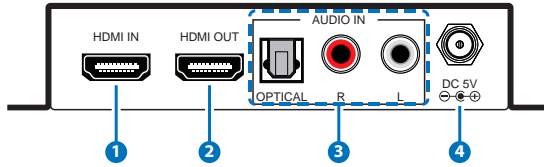

- 1 **HDMI IN:** Connect to HDMI source equipment such as a media player, game console or set-top box.
- 2 **HDMI OUT:** Connect to an HDMI TV, monitor or amplifier for digital video and audio output (LPCM up to 7.1, Bitstream, HD Bitstream).
- 3 **OPTICAL IN:** Connect to the optical audio output of a device such as an AV receiver, CD player, or DVD player.
L/R IN: Connect to the stereo analog output of a device such as a CD player, PC or DVD player.
- 4 **DC 5V:** Plug the 5V DC power adapter into the unit and connect it to an AC wall outlet for power.

6.3 Virtual COM Port Control

COM PORT SETTINGS	
Baud rate	115200
Data bits	8
Parity	None
Stop bits	1
Flow control	None

COMMAND	DESCRIPTION & PARAMETERS
?	Show the full command list.
HELP	Show the full command list.
P1	Power the unit on.
P0	Power the unit off (Stand-by mode).
P?	Show the current power state.

COMMAND	DESCRIPTION & PARAMETERS
SOURCEDET	Show the current input source detection state.
SINKINFO	Show information about the currently connected display.
HDCPIN N1	Set the HDCP handling mode for the HDMI input. Available values for N1 : 1 [Follow Input] 2 [Follow Output] 3 [Apple Mode]
HDCPIN ?	Show the current HDCP handling mode.
EDIDIN N1	Set the EDID to use with the HDMI input. Available values for N1 : 1 [FHD/2CH] 2 [FHD/MCH] 3 [4K UHD/2CH] 4 [4K UHD/MCH] 5 [4K UHD+/2CH] 6 [4K UHD+/MCH] 7 [User EDID] 8 [Sink's EDID]
EDIDIN ?	Show the current EDID selection.
ECHO N1	Set the console text echo mode behavior. Available values for N1 : 0 [Text echoing is off] 1 [Text echoing is on]
ECHO ?	Show the current text echoing mode.
FADEFAULT	Reset the unit to the factory defaults.
VER	Show the unit's current firmware version.
REBOOT	Reboot the unit.

Note: Commands will not be executed unless followed by a carriage return. Commands are not case-sensitive.

6.4 EDID Commander

- (1) This unit uses an EDID Management application which allows the user to copy the EDID from an attached display, edit an existing EDID file stored on the PC or create a basic EDID from scratch. The EDID can then be uploaded to the unit for use.
- (2) Please obtain the EDID Management software from your authorized dealer and save it in a directory where you can easily find it.
- (3) Before connecting the unit to your PC, please install the appropriate Virtual COM Port Driver depending on your Windows version. Next, install the EDID Management software.
- (4) After the installation has successfully completed, an icon for it will appear on the windows desktop. Launch the software by double-clicking on the icon and the EDID Management device detection window will open up on your screen.

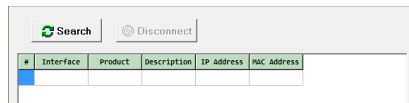

- (5) After launching the software, power the unit on and then connect it to the PC/laptop using a USB cable. Click on the "  Search" button and any detected units will be displayed in the list. Clicking on a detected unit will open the EDID Commander window.

6.4.1 EDID Controller Tab

- **Mode Select:** The currently selected EDID is displayed here and can be changed by selecting from any of the available EDID options.

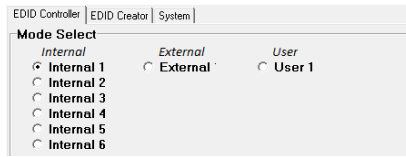



- There are six pre-defined “Internal” EDIDs, an “External” EDID which passes the EDID from the connected display, and a “User” EDID which is user-replaceable.
- To return the User EDID to its original value, please perform a factory reset on the unit.
- The six Internal EDIDs are:
 - **FHD/2CH**..... 1080p@60Hz with LPCM 2.0
 - **FHD/MCH** 1080p@60Hz with LPCM 7.1 & Bitstream
 - **4K UHD/2CH**..... 4K@30Hz with LPCM 2.0
 - **4K UHD/MCH**..... 4K@30Hz with LPCM 7.1 & Bitstream
 - **4K UHD+/2CH**..... 4K@60Hz (4:4:4, 8-bit) with LPCM 2.0
 - **4K UHD+/MCH** 4K@60Hz (4:4:4, 8-bit) with LPCM 7.1 & Bitstream
- **Save/Upload/Analysis:** EDIDs may be saved to a PC, uploaded from a PC or analyzed.





- **Save:** Any EDID from the unit or the connected HDMI display can be saved to your PC as a *.bin file by selecting the EDID source from the drop down menu and then clicking the “ Save” icon.
- **Upload:** Previously saved EDID files (*.bin format) can be re-uploaded into the unit by selecting the User EDID to replace from the dropdown and then clicking the “ Upload” icon. Before accepting the upload, the software will check and verify that the EDID’s header and checksum values are acceptable.

- **Analysis:** To analyze any EDID stored within the unit, select the EDID to view from the dropdown and click on the “ Analysis” icon.

6.4.2 EDID Creator Tab

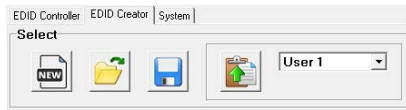
- **Select:** Click on the EDID Creator tab to begin designing a new EDID from scratch (select the “ New” icon), to modify an existing EDID stored on the PC as a .bin file (select the “ Load” icon) or to edit an EDID copied from the unit via the EDID Analyzer's edit option.



- Selecting “ New” will automatically populate the various EDID fields with basic information that can be easily edited to match the user’s preferences.
- Clicking on the “ Load” icon will open a file load window and after the *.bin file has been selected and loaded the EDID fields will be populated with the information from that file. The same will happen when the EDID is copied from the EDID Analyzer window.
- **Edit:** The following tabs provide access to a wide range of EDID information which can be edited:

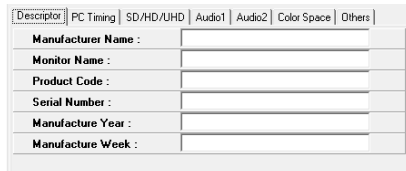

- **Descriptor:** This tab allows for the editing of various description and information fields within the EDID file such as Manufacturer Name, Monitor Name, etc.
- **PC Timing & SD/HD/UHD:** These tabs allow for the selection of the resolutions and refresh rates that the EDID will report as supported.
- **Audio1 & Audio2:** These tabs allow for the selection of which audio formats, audio frequencies, channels and speaker locations are supported.
- **Color Space:** This tab allows for the selection of which color formats and bit depths are supported, including BT.2020 and HDR

support options.

- **Others:** This tab contains options for supporting 3D and defining the CEC Address.

Once the user is finished editing or creating an EDID it can be saved to a *.bin file locally or uploaded directly to the unit using the “ Save” and “ Upload” icons respectively.

6.4.3 System Tab

- **Configuration & Firmware:** Select the System tab to edit the unit’s description (select the “ Rename” icon), to reset the unit to factory defaults (select the “ Reset” icon) and to view the unit’s current hardware and firmware version information.

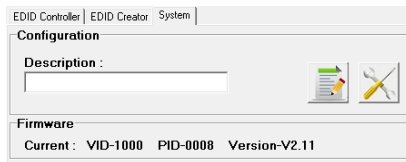

7. CONNECTION DIAGRAM

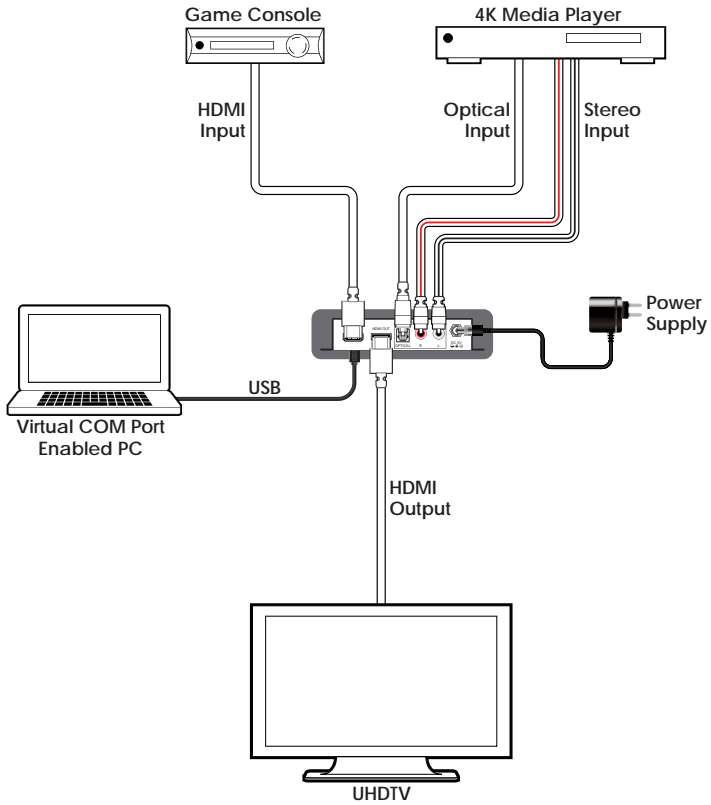



8. SPECIFICATIONS

8.1 Technical Specifications

HDMI Bandwidth	600MHz/18Gbps
Input Ports	1×HDMI 1×Optical (S/PDIF) 2×RCA (Stereo)
Output Port	1×HDMI
Control Interface	1×USB Mini-B
HDMI Cable Length	10m (1080p@60Hz, 12-bit) 3m (4K@60Hz, 4:4:4, 8-bit)
Baud Rate	Up to 115200bps
Power Supply	5V/2.6A DC (US/EU standards, CE/FCC/UL certified)
ESD Protection	Human Body Model: ±8kV (Air Discharge) ±4kV (Contact Discharge)
Dimensions	128mm×25mm×108mm (W×H×D) [Case Only] 128mm×25mm×118mm (W×H×D) [All Inclusive]
Weight	358g
Chassis Material	Metal
Silkscreen Color	Black
Operating Temperature	0°C - 40°C/32°F - 104°F
Storage Temperature	-20°C - 60°C/-4°F - 140°F
Relative Humidity	20 - 90% RH (Non-condensing)
Power Consumption	3.78W

8.2 Video Specifications

Standard Resolution Support		Input	Output
640×480	60, 72, 75, 85	✓	✓
800×600	56, 60, 72, 75, 85	✓	✓
1024×768	60, 70, 75, 85	✓	✓
1280×720	50, 60	✓	✓
1280×768	60, 75, 85	✓	✓
1280×800	60	✓	✓
1280×1024	60	✓	✓
1360×768	60	✓	✓
1600×1200	60	✓	✓
1920×1200	60 (RB)	✓	✓
720×480p	60	✓	✓
720×576p	50	✓	✓
1280×720p	60	✓	✓
1920×1080i	50, 60	✓	✓
1920×1080p	24, 25, 30, 50, 60	✓	✓
3840×2160p (YUV 4:2:0)	50, 60	✓	✓
4096×2160p (YUV 4:2:0)	50, 60	✓	✓
3840×2160p	24, 25, 30, 50, 60	✓	✓
4096×2160p	24, 25, 30, 50, 60	✓	✓



8.3 Audio Specifications

Input/Output Audio Analysis:

Measurement	Input Connector		
	HDMI	Optical	Analog
Level	0dBfs	0dBfs	2Vrms
Frequency	1kHz	1kHz	1kHz

Measurement	Output Connector
	HDMI
Output Level	0~-1dB
THD+N	<0.01%
Frequency Response	±1dBFS
SNR	>80dB
Crosstalk	<-80dB

Audio Sampling Rates:

HDMI	32, 44.1, 48, 88.2, 96, 176.4, 192kHz (Passthrough)
S/PDIF	32, 44.1, 48, 88.2, 96, 192kHz (Passthrough)

9. ACRONYMS

ACRONYM	COMPLETE TERM
3D	Three-Dimensional
ARC	Audio Return Channel
CEC	Consumer Electronics Control
COM	Communication
DAC	Digital-to-Analog Converter
DVI	Digital Visual Interface
EDID	Extended Display Identification Data
HD	High-Definition
HDCP	High-bandwidth Digital Content Protection
HDMI	High-Definition Multimedia Interface
HDR	High Dynamic Range
LED	Light-Emitting Diode
LPCM	Linear Pulse-Code Modulation
PC	Personal Computer
S/PDIF	Sony/Philips Digital Interface Format
SD	Standard-Definition
UHD	Ultra-High-Definition
USB	Universal Serial Bus



CYPRESS TECHNOLOGY CO., LTD.

www.cypress.com.tw