

an introduction to
the projector

CR series
User Manual



1 Contents of this User's Guide

1	Introduction	6
1.1	Thank you	
1.2	Features	
2	Safety Instructions	9
2.1	SAFETY	
2.2	GENERAL WARNINGS	
2.2.1	INFORMATION AND WARNING ABOUT POTENTIAL HEALTH ISSUES RELATED TO MERCURY VAPOR (UHP lamps only)	
2.2.2	HEAVY DUTY AND CONTINOUS USE (UHP lamps only)	
2.2.3	SERVICE PERSONNEL INFORMATION WARNING (UHP lamps only)	
2.2.4	REMOTE CONTROL WARNING	
2.2.5	WARNING SYMBOLS	
2.3	FCC	
2.4	WEEE INFORMATION	
2.4.1	Turkey RoHS compliance	
2.5	ENVIRONMENTAL INFORMATION	
2.5.1	Disposal Information	
2.5.2	Disposal of batteries in the product	
2.6	SERVICE INFORMATION	
3	What's in the box?	13
4	Getting to know the projector	15
4.1	Overview	
4.2	Indicators	
4.2.1	The status indicator	
4.2.2	Keypad	
4.2.3	Remote control	
4.3	Connectivity	
4.4	Graphical User Interface (GUI)	
5	Basic setup	21
5.1	Lens	
5.1.1	Lens and lens mount	
5.1.2	Inserting a lens	
5.1.3	Replacing a lens	
5.2	Adjusting on screen image size and position	
5.3	Lamp operation	
5.4	Projector rotation	

- 5.5 Ceiling mount
 - 5.5.1 Ceiling mount cover (optional)
 - 5.5.2 Attaching the ceiling cover
- 5.6 Connection and cables
 - 5.6.1 Setting up a video source
 - 5.6.2 Setting up a computer source
 - 5.6.3 Connecting command and control interfaces
 - 5.6.4 Attaching X-PORT™ modules
- 5.7 Using X-PORT™ modules
 - 5.7.1 X-PORT DCC120
 - 5.7.2 X-PORT 3G-SDI
- 5.8 Image alignment
- 5.9 Setting image orientation
- 5.10 Using source scan
- 5.11 Limiting OSD messages
- 5.12 Changing the language of the menu system
- 5.13 Identifying system status
 - 5.13.1 Getting information about the active source
- 5.14 Using the dual lamp system (UHP models only)
- 5.15 Image size

- 6 Advanced setup 31
 - 6.1 Controlling multiple projectors with remote control ID (RCID)
 - 6.2 Protecting the projector with a pin code
 - 6.3 Using dual head input
 - 6.4 Setting custom color space and digital level
 - 6.5 Disabling IR receivers
 - 6.6 Controlling screens with triggers
 - 6.7 Setting aspect trigger behavior
 - 6.8 Automatic power on/off
 - 6.8.1 Using the timer
 - 6.8.2 Using DPMS (Display Power Management Signaling)
 - 6.9 Disabling LED indicators
 - 6.10 Setting the background color
 - 6.11 Selecting the startup logo
 - 6.12 Setting OSD menu timeout
 - 6.13 Selecting the startup logo

- 7 Optimising the picture 35
 - 7.1 Calibration data
 - 7.1.1 Updating RealColor™ calibration data
 - 7.2 Working with RealColor™
 - 7.2.1 Setting the BrilliantColor™ correctly
 - 7.2.2 Gamma
 - 7.2.3 RealColor™ operating modes
 - 7.2.4 Setting a white point or color temperature
 - 7.2.5 Defining the system color gamut

- 8 Maintenance 41
 - 8.1 Software upgrades
 - 8.2 Lamp replacement (UHP units only)

- 9 Technical specifications 43
 - 9.1 Product details

1 Introduction

1.1 Thank you

Thank you for purchasing this projector.

When referring to the term CR-series in this document, it means that the content is applicable for following Barco products:

- CRPN-52B • CRPN-62B
- CRWQ-62B • CRWQ-72B

The CR series projectors set an industry benchmark for projectors in its size and performance category. Featuring high resolution DLP technology, high performance optics and lenses, updated signal processing and built-in frame-lock synchronisation makes it the ideal projector for multi-channel visualisation and simulation applications, where realism and reliability are key criteria.

1.2 Features

- panorama (2560x1080) or WQXGA (2560 x 1600) resolution single chip DLP® technology
- Patented Dual Architecture or LED illumination system and optics
- RealColor advanced colour management suite
- Fail safe, hot swap Dual Lamp architecture or longlife LED illumination
- Dual optomechanical IRIS for customizable brightness and contrast
- Full powered horizontal and vertical lens shift, allows direct stacking
- Full 12-bit colour resolution for minimised artefacting and high accuracy
- BrilliantColor™ technology with six-colour processing for accurate colours
- Elevated contrast levels for unmatched image dynamics
- High brightness for large screen applications
- Range of application specific colour wheel options
- Wide range of projection lenses
- Highly versatile colour management and calibration options
- Built-in real time clock for timed operations
- Sigma Designs™ technology video de-interlacing and processing
- Economy mode for reduced power consumption and prolonged lamp life
- Small and ergonomic footprint, with low weight
- Direct view status monitor and lamp function indicators
- Multiple video and graphics inputs for virtually any video and data source
- Dual Link DVI (330 MHz)
- HDMI ver. 1.3a
- LAN and RS232 for control and monitoring

Symbols used in this documentation

 **WARNING:** Used to point out potential danger to people or equipment when using this product or peripheral equipment.

 **NOTE:** Used to point out essential handling requirements for the projector, which if not acted on may cause product malfunctioning.

 **TIP:** Used to give advice which benefits the projector usage or conditions related to projector performance.

The specifications and functionality of this projector may change without prior notice

2 Safety Instructions

This device complies with safety regulations for Information Technology Equipment for use in an office environment. Before using the device for the first time, please read the safety instructions thoroughly.

2.1 SAFETY

This user guide contains important information about safety precautions and the set-up and use of the projector. Please read the manual carefully before you operate the projector.

2.2 GENERAL WARNINGS

Use only the cables and cords supplied with the projector or original replacement cables. Using other cables or cords may lead to malfunction and permanent damage of the unit.

Always use 3-prong / grounded power cord to ensure proper grounding of the unit. Never use 2-prong power cords, as this is dangerous and could lead to electrical shock.

Never open the unit. The projector contains no user serviceable parts. Refer all repairs to qualified personnel only. Make sure that no objects enter into the vents and openings of the set.

Do not spill any liquids on the projector or into the vents or openings of the unit.

Always remove lens cap before switching on the projector. If the lens cap is not removed, it may melt due to the high energy light emitted through the lens. Melting the lens cap may permanently damage the surface of the projection lens.

Do not look into the projection lens when the projector is switched on. The strong light may permanently damage sight. Do not look into the laser beam when activated on the remote control. Laser light may permanently damage sight.

Do not point laser beam at people or animals.

Only place the projector on a stable surface, or mount it securely using an approved ceiling-mount.

Do not drop the projector.



Always operate the projector according to the rotation guidelines. Operating the unit in other positions may reduce lamp life significantly, and may lead to overheating, resulting in malfunctioning.

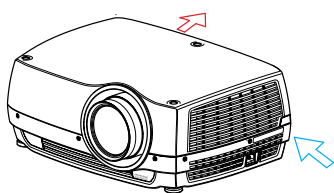

Always allow ample airflow through the projector. Never block any of the air vents. Never cover the unit in any way while running. Allow for sufficient distance to walls and ceilings to avoid overheating.

Minimum safety distance to any side of the unit is 50 cm / 20" in any direction.

Hot air is exhausted from the rear vent. Do not place objects that are sensitive to heat nearer than 50cm / 20" to the exhaust vent.

The projector is designed for indoor use only. Never operate the unit outdoors.

Do not operate the projector outside its temperature and humidity specifications, as this may result in overheating and malfunctioning.



Connecting sources to a powered projector may result in product failure. It is recommended that the power cable connector (projector-end) or the mains power socket are accessible while the product is in use to enable mains power to be disconnected or switched off when connecting source devices. This should be considered during product installation.

Only connect the projector to signal sources and voltages as described in the technical specification. Connecting to unspecified signal sources or voltages may lead to malfunction and permanent damage of the unit.

In order to prevent damage to the projector caused by overvoltages (e.g. lightning), we recommend connection to a line (mains) circuit which has overvoltage protection.

Allow lamp to cool down before changing. One lamp may be changed while the other lamp is operating (hot-swap). **USE ONLY ORIGINAL LAMPS.**

2.2.1 INFORMATION AND WARNING ABOUT POTENTIAL HEALTH ISSUES RELATED TO MERCURY VAPOR (UHP lamps only)

This projector uses a very powerful UHP™ lamp for illumination to produce an extremely bright image.

This technology is similar to other high-pressure discharge lamps that are extensively used in cars, street lights and other lighting appliances today. These lamps, like fluorescent lighting, contain small amounts of mercury. The amount of mercury present in a lamp is far below the limits of danger. It is very important that lamps containing mercury are treated properly to minimize potential health hazards.

The UHP™ lamp, like any other high brightness projector lamp, is under high-pressure when operating. While the lamp and the projector are carefully designed to minimize the probability of lamp rupture, the lamp may break while operating and small amounts of mercury vapor may be emitted from the projector. The probability of rupture increases when the lamp reaches its expected lifetime. It is therefore highly recommended that the lamp is replaced when the rated lifetime is reached.

As a general precaution, secure good ventilation in the room when operating the projector. If lamp rupture occurs, evacuate the room and secure good ventilation. Children and pregnant women in particular should leave the room.

When replacing a worn lamp, dispose of the used lamp carefully by proper recycling.

Mercury is a naturally occurring, stable metallic element that may pose a safety risk to people under certain conditions. According to the Public Health Statement for Mercury published by the Agency for Toxic Substances and Disease Registry (“ATSDR”, part of the United States Public Health Service), the brain, central nervous system and kidneys are sensitive to the effects of mercury, and permanent damage can occur at sufficiently high levels of exposure. Acute exposure to high concentrations of mercury vapor can cause conditions such as lung and airway irritation, tightness in the chest, a burning sensation in the lungs, coughing, nausea, vomiting and diarrhea. Children and fetuses are particularly sensitive to the harmful effects of metallic mercury to the nervous system.

Seek medical attention if any of the above symptoms are experienced or if other unusual conditions are experienced following lamp rupture.





2.2.2 HEAVY DUTY AND CONTINUOUS USE (UHP lamps only)

The projector contains moving parts (such as cooling fans) that have limited life-expectancies. When the projector has been used for 8 000 hours, and when the unit is used in mission-critical applications, it is recommended that the projector is given preventive maintenance by a qualified service person. A message will appear on the screen when the projector is due for preventive maintenance. This will help ensure long term stable operation.

2.2.3 SERVICE PERSONNEL INFORMATION WARNING (UHP lamps only)







Use UV radiation eyes and skin protection during servicing.

2.2.4 REMOTE CONTROL WARNING

-  Laser radiation class II product; wavelength 670nm; maximum output 1mW.
-  Remote control complies with applicable requirements of 21 CFR 1040.10 and 1040.11.
-  Remote control complies with applicable requirements of EN/IEC 60825-1/2007
-  **Use of controls or adjustments, or performance of procedures other than those specified in the User Guide, may result in hazardous radiation exposure.**

2.2.5 WARNING SYMBOLS

Here is a list of warning symbols found on the product label(s):

-  **READ USER GUIDE Attention!** Read the user guide for further information!
-  **DANGEROUS VOLTAGE Danger!** High voltage inside the product!
-  **HOT Warning!** Hot surfaces!
-  **WAIT Warning!** Wait until cooled down!
-  **MERCURY Warning!** Lamp contains mercury! Recycle properly, do not dispose of in ordinary waste!
-  **UV Warning!** UV radiation inside the product!
-  **RECYCLE Warning!** Recycle properly, do not dispose of in ordinary waste!

2.3 FCC

FCC regulations provide that changes or modifications not expressly approved by the party responsible manufacturer could void your authority to operate the equipment.

-  **This equipment has been tested and found to comply with the limits for a Class A digital device, pursuant to part 15 of the FCC Rules. These limits are designed to provide reasonable protection against harmful interference when the equipment is operated in a commercial environment. This equipment generates, uses, and can radiate radio frequency energy and, if not installed and used in accordance with the instruction manual, may cause harmful interference to radio communications. Operation of this equipment in a residential area is likely to cause harmful interference in which case the user will be required to correct the interference at his own expense.**

This device complies with part 15 of the FCC Rules. Operation is subject to the following two conditions:

- (1) This device may not cause harmful interference, and
- (2) this device must accept any interference received, including interference that may cause undesired operation.

CANADA

This Class A digital apparatus complies with Canadian ICES-003. / Cet appareil numérique de la classe A est conforme à la norme NMB- 003 du Canada.

WARNING

-  **This is a Class A product. In a domestic environment this product may cause radio interference, in which case the user may be required to take adequate measures.**

2.4 WEEE INFORMATION

This product conforms to all requirements of the EU Directive on waste electrical and electronic equipment (WEEE). This product shall be recycled properly. It can be disassembled to facilitate proper recycling of its individual parts. This product is using projection lamps that shall be recycled properly. Consult your dealer or relevant public authority regarding drop-off points for collection of WEEE.

2.4.1 Turkey RoHS compliance



Türkiye Cumhuriyeti: EEE Yönetmeliğine Uygundur.
(Republic of Turkey: In conformity with the EEE Regulation)

2.5 ENVIRONMENTAL INFORMATION

2.5.1 Disposal Information

Waste Electrical and Electronic Equipment



This symbol on the product indicates that, under the European Directive 2002/96/EC governing waste from electrical and electronic equipment, this product must not be disposed of with other municipal waste. Please dispose of your waste equipment by handing it over to a designated collection point for the recycling of waste electrical and electronic equipment. To prevent possible harm to the environment or human health from uncontrolled waste disposal, please separate these items from other types of waste and recycle them responsibly to promote the sustainable reuse of material resources.

For more information about recycling of this product, please contact your local city office or your municipal waste disposal service.

For details, please visit the Barco website at: <http://www.barco.com/en/AboutBarco/weee>

2.5.2 Disposal of batteries in the product



This product contains batteries covered by the Directive 2006/66/EC which must be collected and disposed of separately from municipal waste.

If the battery contains more than the specified values of lead (Pb), mercury (Hg) or cadmium (Cd), these chemical symbols will appear below the crossed-out wheeled bin symbol.

By participating in separate collection of batteries, you will help to ensure proper disposal and to prevent potential negative effects on the environment and human health.

2.6 SERVICE INFORMATION

This product contains no user serviceable parts. If the product fails to function as expected, please first check that all connections are properly made, and that the power cord is properly connected. Please check that the projector as well as the video and computer sources are all switched on. Cables and cords may break over time. Try to change cables and cords, in case there is a bad or intermittent connection. Check if the circuit breaker or fuse of your mains is intact. In the event of product failure, please contact your reseller. You should prepare a description of the symptoms of failure you experience. Please also state product number and serial number as printed on the label on the bottom of the projector.

3 What's in the box?

The following components are standard delivery:

Projector



Power Cable (Country Dependent)



Remote Control



User Documentation



Additional accessories available for the projector:

DVI-cable



Please verify that you have all components upon unpacking the unit, and its contents. Check next page for additional accessories.



Please save packaging materials for future use, should it be necessary to ship the unit.

4 Getting to know the projector

4.1 Overview

- A Lens
- B IR sensor
- C1 Ventilation - Air flow IN
- C2 Ventilation - Air flow OUT
- D Lens release
- E Power connector
- F Keypad
- G Connector panel
- H LCD
- I Lamp lids*
- J Adjustable feet
- K Security lock
- L Ceiling mount

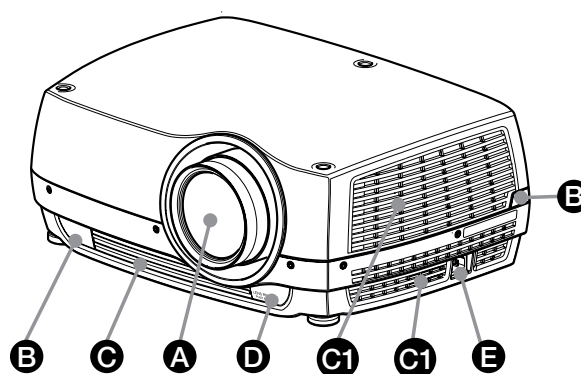

Figure 4-1. - Projector front view

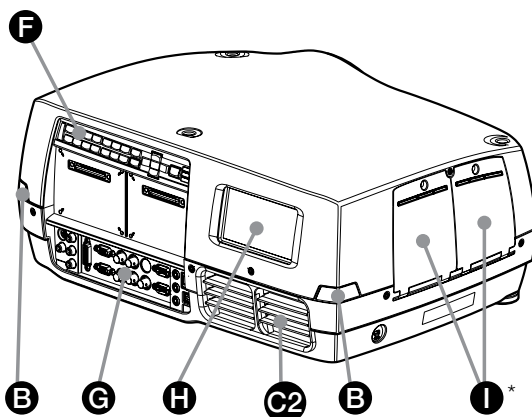

Figure 4-2. - Projector rear view

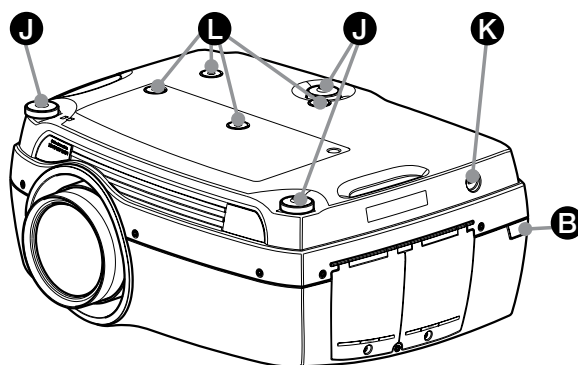

Figure 4-3. - Projector bottom view

* Features in the user guide pictures/drawings may be different from your projector depending on model/version.

4.2 Indicators

System status indicators are located right of the keypad on the back of the projector. Figure 4-4 shows the three status indicators – one for each lamp and one for the system status.



* Pictures show backpanel of projector with UHP lamps.
LED illumination projectors have one indicator lamp (LED), instead of two (LAMP 1, LAMP 2).

Figure 4-4. The lamp indicators

For the lamp indicators the following apply:

- PERMANENT GREEN LIGHT: The lamp is on and operating normally.
- PERMANENT YELLOW LIGHT: The lamp is off. The lamp may be disabled in the menu or the system is in standby.
- PERMANENT RED LIGHT: Lamp life has expired, lamp is not igniting or lamp door is open. If the lamp life has expired, please change projection lamp immediately. Failing to change lamp may lead to lamp explosion. Please replace with original projectiondesign replacement lamp.
- FLASHING YELLOW LIGHT: The lamp is cooling down. The total cooling down time is approx. 45 seconds.
- NO LIGHT: No lamp inserted.

! **The replacement lamps must be purchased from an authorized projectiondesign dealer for the warranty of the product to be valid. Using lamps from any other after market supplier will void the warranty.**

4.2.1 The status indicator

- PERMANENT GREEN LIGHT: The projector is turned on and in normal operation.
- PERMANENT YELLOW LIGHT: The projector is in standby mode. If the projector was powered off by the power saving feature (DPMS), it will automatically power on when you connect a valid source.
- FLASHING YELLOW LIGHT: Please wait. The yellow light will flash a period after power cord is connected (20-30 sec.), and a period after going to standby mode while lamp is cooling down (approximately 45 sec.). The projector may not be turned on again until the light has turned to permanent yellow.
- FLASHING RED LIGHT: Projector is overheated. Turn off immediately! Check if air inlets are covered or if ambient temperature is outside specifications. The projector cannot be restarted until the power cord is disconnected and reconnected again. If the projector continues to flash red, you will need to return the unit for service.

4.2.2 Keypad

The projector has an illuminated keypad on the back of the unit. Figure 4-5 shows the keypad.



Figure 4-5. Projector keypad

* Pictures show backpanel of projector with UHP lamps.
LED illumination projectors have one indicator lamp (LED), instead of two (LAMP 1, LAMP 2).

The keypad is used to:

- navigate the menu system
- scroll the information in the LCD panel
- directly select input sources
- enter pin code (if enabled)
- power on/off
- adjust basic image functions

The keypad is illuminated for operation in dark environments. Available functions are illuminated in yellow while selected (active) functions are illuminated in green. Functions that are not available are not illuminated.

4.2.3 Remote control

The remote control allows flexible access to the projector settings, either through direct keys, or through the menu system. The remote control is backlit for use in dark environments. It also has a data-jack that allows for wired connection to the projector. When the wire is connected, the IR (infra-red) beam and internal batteries are switched off.

! The direct sources buttons for VGA1, VGA2, X-Port 2 and YPbPr are not available for all versions of the product. If your product does not have these inputs implemented the OSD will display “not available” when pressing these buttons.



! Do not look into the laser beam when activated on the remote control. Laser light may permanently damage eyesight. Avoid pointing the laser beam at people or animals.

! Only use the supplied remote control, otherwise the result may be malfunction.

Figure 4-6. Remote control

4.3 Connectivity

The projector features a wide range of video inputs and command/control connectors. Figure 4-7 shows the connector panel.

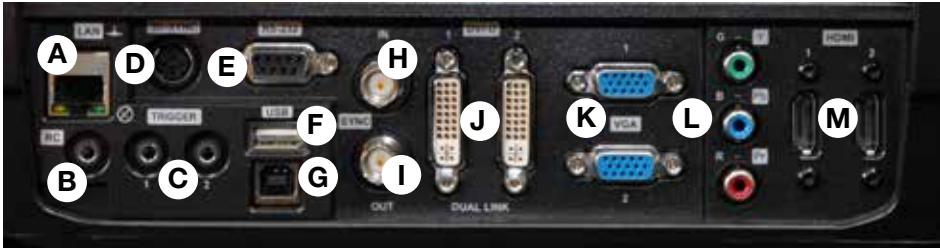

Figure 4-7. Connector panel

- A** LAN: 10/100 Mbit Ethernet connector for command, control and software upgrade.
- B** RC INPUT: 3.5mm mini-jack connector. Allows connection of external IR receiver or wired remote control.
- C** TRIGGERS: 3.5mm mini-jack connector triggers. Used for controlling peripheral equipment like motorized screens.
- D** Not used
- E** RS-232: Allows for wired remote control and monitoring of many projector functions used in installation environments.
- F** USB-A: Allows for software upgrades using a standard USB memory stick.
- G** USB-B: Reserved for future use.
- H** SYNC-IN: Allows for taking an external vertical sync signal and using that with the select video input. This is mainly used in multiple projector installations with requirement of video synchronization between the units.
- I** SYNC-OUT: Constantly outputs the vertical sync signal of the active video input. This is mainly used in multiple projector installations with requirement of synchronization between the units.
- J** DVI-D: Two Dual Link DVI-D connectors with bandwidth up to 330 Mhz total. These connectors can also be used to form one uniform image by feeding half of the image into each connector. HDCP compliant for sources up to 165 Mhz.
- K** VGA: Two VGA connectors with bandwidth up to 170 Mhz
- L** YPbPr: Analog video input supporting YPbPr and RGB (sync-on-green) video standard up to 1080i.
- M** HDMI 1.3: Two HDMI 1.3a connectors with bandwidth up to 165 Mhz each. These connectors can also be used to form one uniform image by feeding half of the image into each connector. HDCP compliant. All video formats specified by the HDMI 1.3a are supported.

4.4 Graphical User Interface (GUI)

The projector has an easy-to-use on screen display (OSD) system for controlling the extensive number of features implemented. Figure 4-8. Top level OSD menu, shows the top level of the OSD menu.



Figure 4-8. Top level OSD menu

Activate the menu by pressing the “MENU” button on either the keypad or the remote control. Navigate the menu using the arrow keys.

The various functions in OSD menu is described in Chapter “5 Basic setup”.

5 Basic setup

5.1 Lens

5.1.1 Lens and lens mount

A range of fixed and zoom lenses is available to cover most applications, both both for front and rear projection. The lenses are powered and fitted with a bayonet mount for ease of installation.



Switch off all equipment before setting-up for proper function.

When mounting and changing lenses, be aware that the optical system is exposed to dust and foreign particles as long as the lens is not attached to the system. Do not leave the lens mount open longer than necessary to change lens. If a lens is not mounted, always insert the protection lid to avoid dust and foreign particles entering the internal optics.



Never run the projector without lens mounted.

5.1.2 Inserting a lens

To insert a lens please follow this procedure:

- A** Remove the protection lid from the bayonet mount by turning the knob anti-clockwise.
- B** Remove the rear lens cap.
- C** Attach the projection lens using the bayonet mount, observing the red insertion marks.
- D** Turn the lens firmly clockwise until it stops with a click.
- E** Remove the lens cap from the projection lens. If you switch the projector on with the lens cap in place, the lens cap may melt, damaging not only the lens cap, but also the projection lens and surrounding parts.

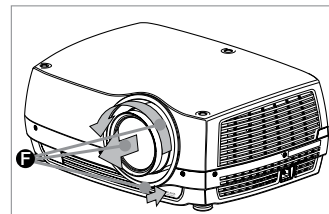
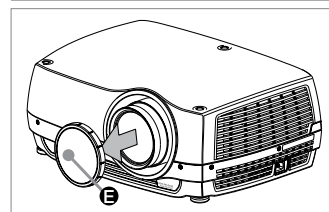
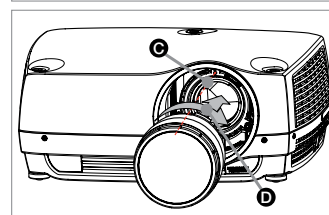
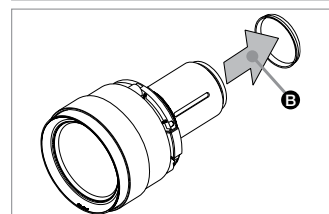
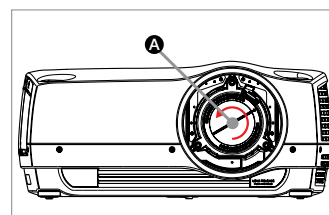

5.1.3 Replacing a lens

To replace a lens please follow this procedure:

- A** To change lens, first remove the current lens by pushing the release button and twisting the lens counter-clockwise until it comes loose. Pull the lens out.
- B** Insert the new lens as described in above.

5.2 Adjusting on screen image size and position

Adjusting the placement of the image on screen can be done using the:

1. Adjustable feet (E in Figure 5-1).
2. Lens shift mechanism controlled from the keypad, the remote control, RS-232 or LAN (A in Figure 9).
3. Zoom (for lenses with zoom) in the lens controlled from the keypad, the remote control, RS-232 or LAN (B in Figure 5-1).

After the correct image size and position is found, please adjust the image focus using the keypad, the remote control, RS-232 or LAN. (C in Figure 5-1).

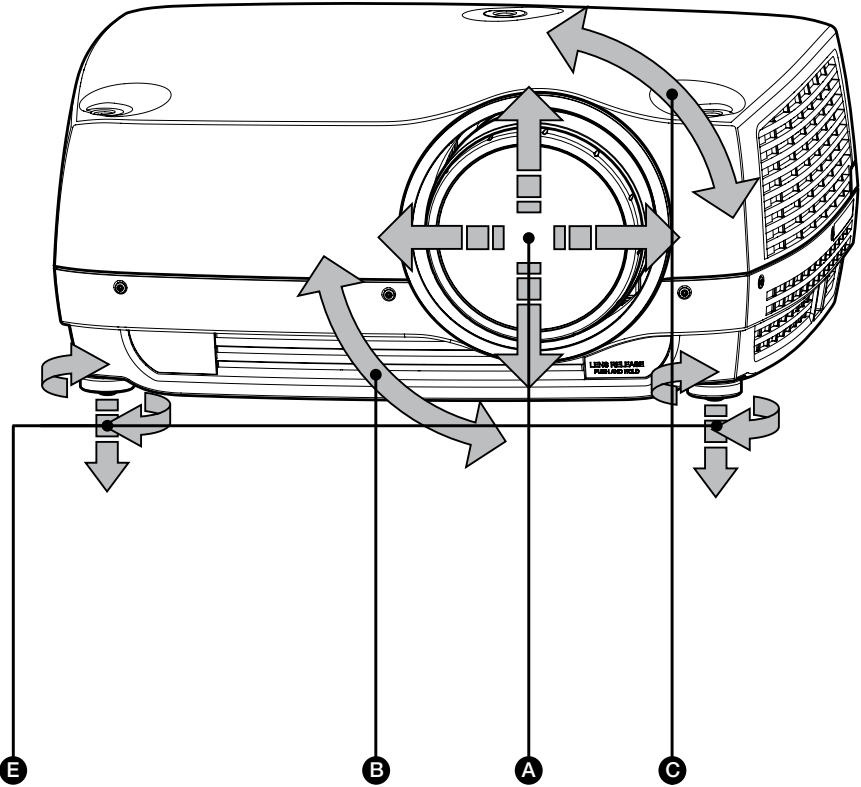

Figure 5-1. Image size and position adjustment

5.3 Lamp operation

The projector is fitted with two individual projection lamps* that can be run in various modes. In addition, lamps can be replaced as needed separately. This ensures an optimized cost of ownership. Individual lamp timers are maintained for each lamp.

Lamp operation mode is controlled in the INSTALLATION > LAMPS sub menu.

* UHP lamp projectors only. LED projectors have only one lamp.

5.4 Projector rotation

Always operate the projector horizontally, within the range of the adjustable front and rear feet. The projector may be rotated so that the lens points downwards. It may not be rotated around the through-the-lens axis.

! Operating the unit in other positions may reduce lamp life significantly, and may lead to overheating, finally resulting in malfunctioning.

5.5 Ceiling mount

The projector can be ceiling mounted using an approved UL tested/ listed ceiling mount fixture, with a capacity of minimum 60 kg / 130 lbs. For ceiling mount use M6 screws that penetrate maximum 15 mm / 0.6" into the projector body. Figure 5-2. Ceiling mount, gives detailed information about the alignment of the ceiling mount screw holes in the projector.

! For proper ventilation the minimum distance from ceiling/ rear wall should be: 30/ 50 cm, 12/ 20 inch.

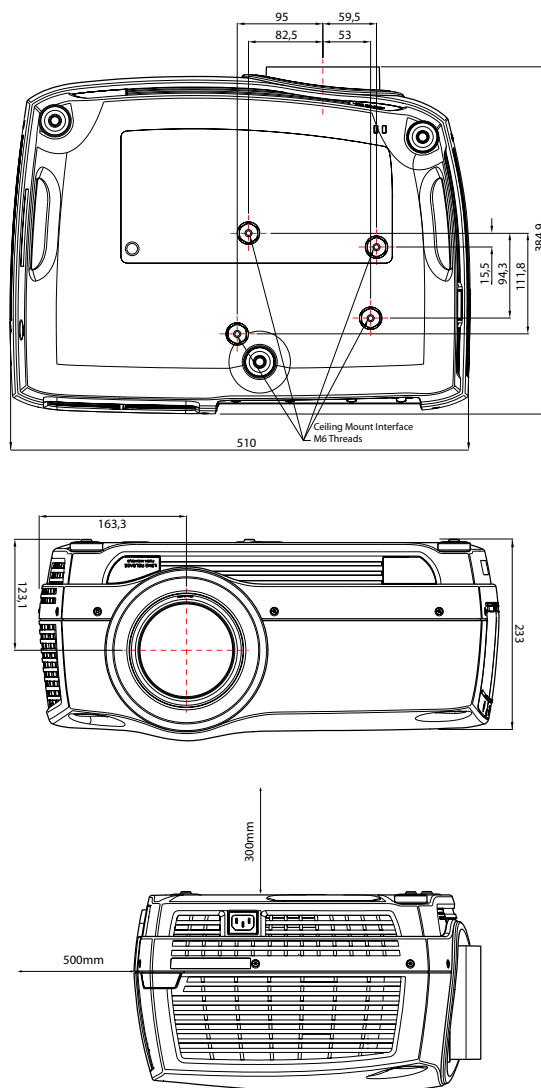

Figure 5-2. Ceiling mount

5.5.1 Ceiling mount cover (optional)

The optional auxiliary cable cover can be mounted on the projector to conceal the interface cables and power cord when the unit is ceiling mounted. Connect all cables and fix them in place before the cable cover is attached to the projector. Figure 5-3 shows the ceiling mount cover.

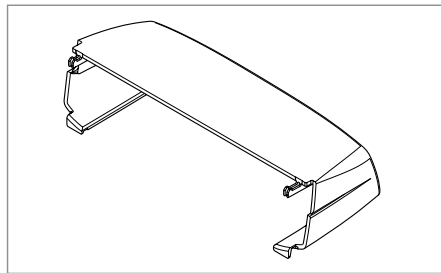
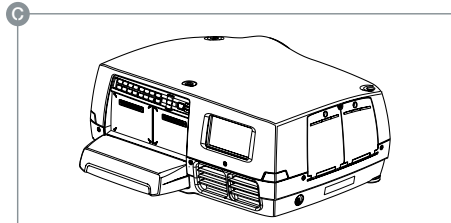
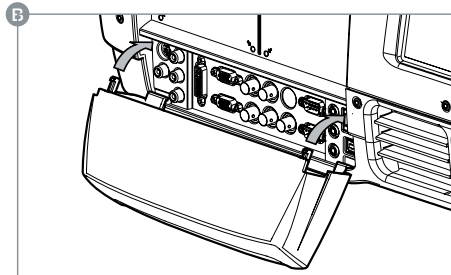
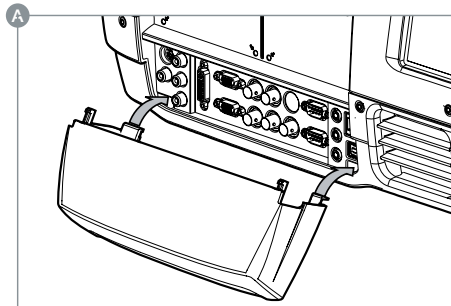

Figure 5-3. The ceiling mount cover

5.5.2 Attaching the ceiling cover

To attach the ceiling mount cover, please follow this procedure:

- A** Attach the cable cover to the projector by inserting the horizontal hooks on the cover in the horizontal slots on the rear of the projector.
- B** Turn the cover until the vertical hooks on the cover are inserted into the vertical slots on the rear of the projector.
- C** The cover will snap in place, to release pull the vertical hooks on the cover out of the slots, letting the cover hinge on the horizontal hooks.



5.6 Connection and cables

! Before setting up, switch off all equipment and disconnect the power cord. In order to prevent damage to the projector caused by overvoltages (e.g. lightning), connect to a line (mains) circuit which has overvoltage protection when installing.

5.6.1 Setting up a video source

For best quality video, connect a digital video source using the HDMI 1.3a interface (O) Connecting a video source in Figure 5-4. The HDMI input is HDCP copy protection compliant. Depending on cable quality, the projector is supporting the use of cables with lengths up to 20 meters (65 feet).



Figure 5-4. Connecting a video source

5.6.2 Setting up a computer source

The projector may be connected to up to six computer sources simultaneously, using the HDMI (O), DVI-D (J) or VGA (K) interfaces, shown in Figure 5-4/Figure 5-5. The digital interfaces (DVI/HDMI) will yield a projected image with very low noise. Both DVI and HDMI are HDCP compliant with sources up to 1920x1200@60Hz (single link source up to 165 Mhz). Additional functionality may be achieved using additional X-PORT connectors like 3G-SDI, DisplayPort 1.1a (se separate sections).



Figure 5-5. Connecting a computer source

! HDCP is not supported on higher resolution sources like 2560x1600@60Hz (WQXGA). Connect the power cord after the other cables have been inserted properly.

5.6.3 Connecting command and control interfaces

The projector is supporting RS-232 and LAN command and control interfaces. Use the ASCII based protocol to communicate with the projector. A detailed description of the ASCII protocol is available for download at www.projectiondesign.com. Connect the power cord after the command and control cables are inserted properly.



Figure 5-6. Connecting command interfaces

5.6.4 Attaching X-PORT™ modules

! X-PORT™ modules are separately available for purchase and not included with the base projector.

! Switch off projector and disconnect power cord before attaching X-PORT™ module. Before attaching any X-PORT module, please make sure you have the latest SW running on the projector. Please go to www.projectiondesign.com to download the current SW and update the projector accordingly. See chapter 8 for details on how to upgrade the projector SW.

The projector supports up to two X-PORT™ modules simultaneously:

- X-PORT™ 1 for additional image processing (X-PORT™ DCC120*). Left hand side.
- X-PORT™ 2 for additional connectivity (X-PORT™ 3G-SDI, X-PORT™ DisplayPort 1.1a and X-PORT™ HDMI 3D*). Right hand side.

**X-PORT™ modules subject to availability.*

To attach an X-PORT™ module, please follow this procedure:

- A** Remove cover plate, by removing the four screws.
- B** Attach module. Observe X-PORT™ 1 and 2 positions are different. Attaching X-PORT™ modules in the wrong position will leave the module non-functional, but it is not destructive.
- C** Fix the four mounting screws securely.

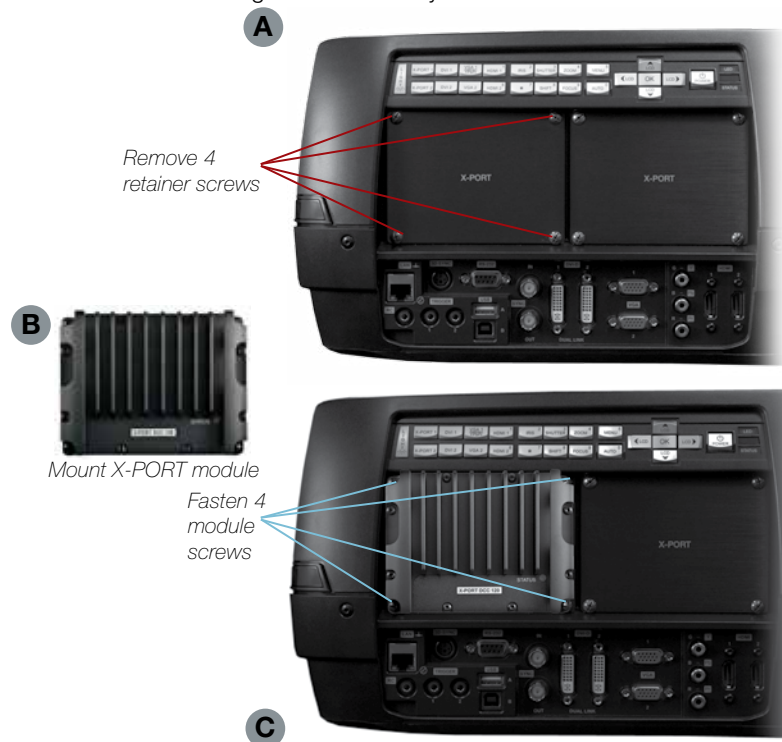

** Features in the user guide pictures/drawings may be different from your projector depending on model/version.*

Finally connect power cord and switch on projector.

! The first time after a module is attached, the projector will automatically update and configure the module. This may take a few minutes. Please ensure that power remains on during this period.

5.7 Using X-PORT™ modules

X-PORT™ modules allows for extra functionality with the projector. This includes more connectivity as well as additional image processing.

Functionality may include extended connectivity (like 3G-SDI).

5.7.1 X-PORT DCC120

X-PORT DCC120 is an X-PORT 1 module (post processing) adding multi-projector synchronization capabilities to the system.

5.7.2 X-PORT 3G-SDI

The X-PORT 3G-SDI module is an X-PORT2 interface module to support all SDI, HD-SDI and 3G-SDI formats.

5.7.2.1 Connectivity

PARAMETER	VALUE
Main connectors	2xBNC-F Input A1, Input B1
Redundancy connectors	2xBNC-F Input A2, Input B2
Video formats	- SDI (SMPTE 259M, up to 360 Mbps) - HD-SDI (SMPTE 292M, up to 1.485 Gbps) - 3G-SDI (SMPTE 424M/425M, up to 3.0 Gbps)
Nominal impedance	75 Ohms
Scan format	Interlaced or progressive
Return loss	<-15 dB, DC @ 1 MHz to 1.5 GHz
Clock rate	Up to 3 Gbit/s (3G-SDI)
Maximum resolution	1920x1080p@60Hz

5.7.2.2 Cable Lengths

PARAMETER	VALUE
3G-SDI	Max 100 m (RG-5 18 AWG/1694A)
HD-SDI	Max 110 m (RG-5 18 AWG/1694A)
SDI	Max 400 m (RG-5 18 AWG/1694A)

5.8 Image alignment

For easier alignment of the projector, test images are built into the system.

To enable test images, go to the menu entry **INSTALLATION > TEST IMAGE**. Cycle the various test images using the arrow keys. When a test image matching the aspect ratio of your screen has been found, use the zoom, focus, lens shift and physical projector alignment to match the screen.

5.9 Setting image orientation

In relation to the screen, the projector supports the following installation orientations:

- Desktop front (default)
- Ceiling front
- Desktop rear
- Ceiling rear

To set the image orientation go to menu entry **INSTALLATION > IMAGE ORIENTATION**

5.10 Using source scan

The projector can automatically scan through all the input connectors for a valid signal. If a valid signal is found, the image will set up. This is called source scan.

Source scan is default disabled. When disabled, the projector will only search the selected input connector for a valid signal. Use the keypad, remote control or any command and control interface to change in selected input interface.

To set the source scan setting, go to menu entry **INSTALLATION > SOURCE SCAN**

5.11 Limiting OSD messages

When detecting sources and using the various features of the projector, OSD messages will appear on the screen. Which messages that are appearing can be partially controlled by the user. The OSD can run in these modes:

- ON. All messages, warning and information OSDs are displayed.
- OFF. No messages are shown.
- Only warnings. Only critical warning messages like temperature overheating will be shown.

Go to menu entry **INSTALLATION > OSD ENABLE** to control the OSD behavior.

5.12 Changing the language of the menu system

The projector menu system has a total of 11 user-selectable languages embedded for easier use all over the world. The default language is English.

The available languages are:

- English
- French
- German
- Spanish
- Russian
- Norwegian
- Swedish

- Korean
- Japanese
- Chinese Simplified
- Chinese Traditional
- Portuguese
- Italian

To change the language of the menu system, just select “LANGUAGE” from the top menu and select your desired language.

5.13 Identifying system status

For ease of use, the projector has a complete menu available for system status. It is easily accessible from the top menu. From this menu the following information can be read:

- Part number
- Serial number
- The year/week the projector was manufactured
- Current software version
- Runtime and remaining time for both lamps
- Total number of operating hours
- All network information
- Current lens mounted
- Currently active source

5.13.1 Getting information about the active source

By selecting STATUS > SOURCE INFORMATION basic information about currently active source is displayed.

If a deeper analysis is required for the currently active source, select STATUS > SOURCE INFORMATION > ADVANCED. This menu provides detailed timing information for the currently active source.

5.14 Using the dual lamp system (UHP models only)

The projector is fitted with two individual projection lamps* that can be run in various modes.

5.15 Image size

2560 x 1600 (WQXGA) / 2560 x 1080 (panorama)

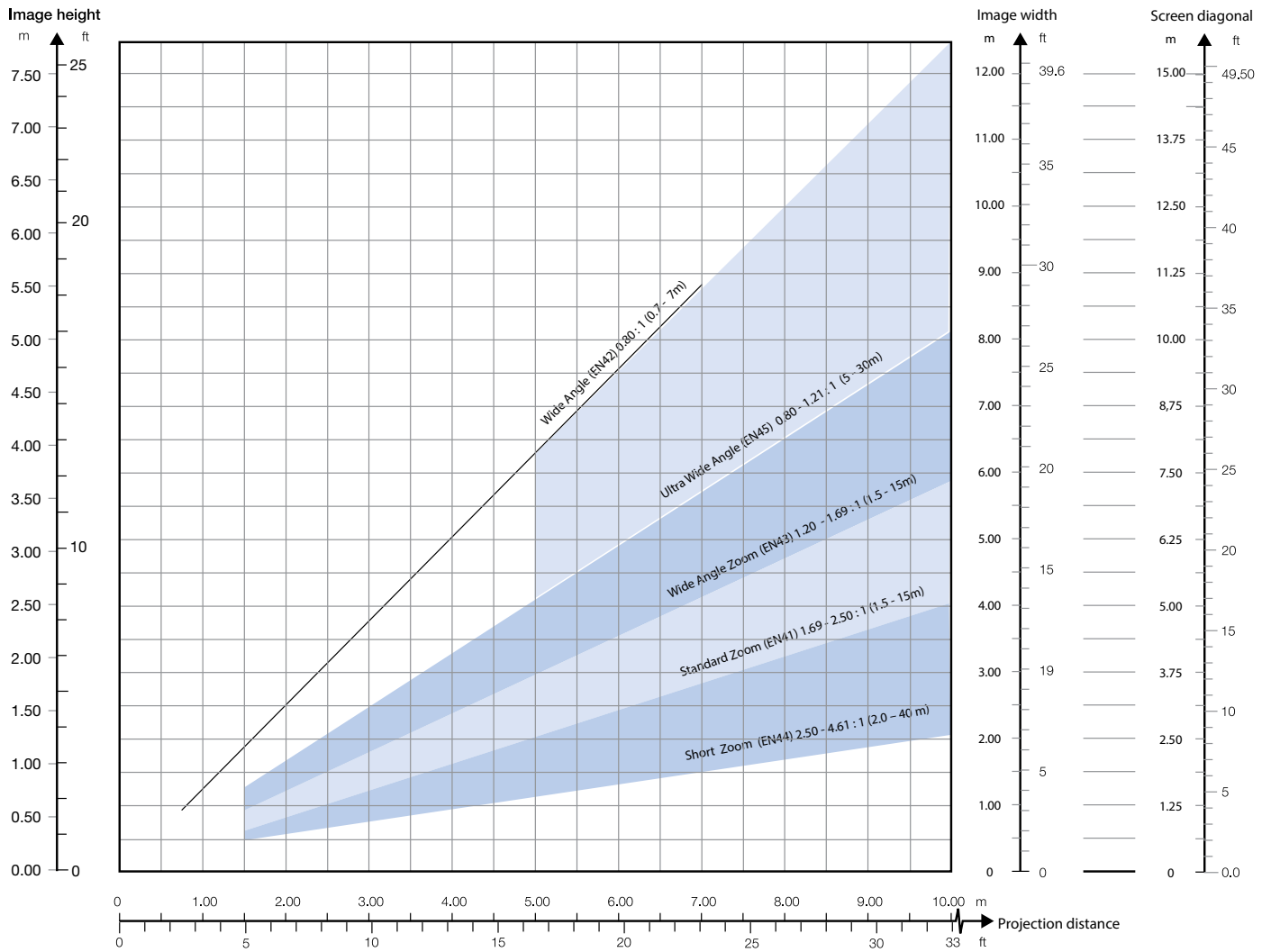

6 Advanced setup

6.1 Controlling multiple projectors with remote control ID (RCID)

The remote control can be operated either in 'broadcast mode', or 'individual mode'. When several projectors are in use in an installation, individual control may be convenient. Individual control is available either by wired remote control, using the data-jack, or by using an individual number code. For individual control, first set the individual RC ID code using the projector menu system, see the SETTINGS sub menu. Then, to select a specific projector to control, first press the '*' button in the lower keypad area, then the code as set in the target projector. A code can be in the range '0'..'99'. '0' is reserved for broadcast. To select another target, repeat the process by pressing '*' and a new code. To exit individual control, press '***' twice or press '*' and '0'.

6.2 Protecting the projector with a pin code

The projector may be controlled by a PIN (Personal Identification Number) code. The PIN code is 4 digits, and if the PIN code is activated, you must enter the correct code to unlock the projector. Factory set PIN (1234).

To activate, deactivate or change the PIN code, see the SETTINGS > PIN CODE sub menu.



**If an incorrect PIN code is entered, you may try again two times.
If you fail three times in a row, a PUK (unlock) code is needed.
The PUK code is supplied with the product.**



Entering the puk code correctly is the customers responsibility

If you also fail three times with the PUK code, the projector locks up permanently, and can only be unlocked by a special service unlock code.

To access this code, you will need to contact your dealer or a service station. The service unlock code will be generated based on a secure, encrypted number that is produced by the projector itself. The projector will produce a new number every time.



To unlock the projector, proof of ownership must be provided by the customer

6.3 Using dual head input

For extended flexibility to connect high resolution sources with a pixel clock over 165 MHz, the projector is supporting a dual head input mode. In this mode the left and right half of the image can be connected to the DVI 1/DVI 2 or HDMI 1/HDMI 2 interfaces respectively (Figure 6-1).

To enable this mode, go to the menu INSTALLATION > DUAL HEAD SETUP. Side-by-side is the only available option at this time.

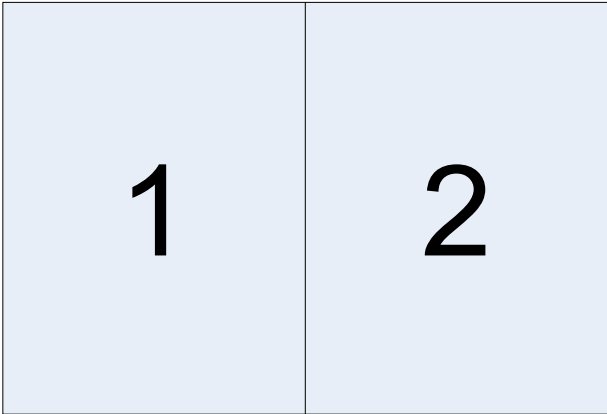

Figure 6-1. Dual input mode

An example of this is feeding a WUXGA (1920 x1200) 120Hz source with 960 x 1200 - 120Hz source resolutions on each the DVI interfaces.

When enabling this mode, the EDID data on each of the DVI connectors will automatically be changed from WUXGA (1920 x 1200) 120Hz to 960 x 1200 - 120Hz.

- !** For the image to be displayed in this mode, the resolution must be exactly the same on both connectors.
- !** In this mode the two connected sources must have exactly the same timing. A drift in timing between the inputs will result in a visible split in the center of image.
- !** Some graphic cards have problems with detecting the change from single head to dual head mode. If problems occur, disconnect both signal cables before enabling or disabling the dual mode in the menu.

6.4 Setting custom color space and digital level

The projector will automatically try to set the correct color space and digital drive level based on information from the source.

To manually override the automatically detected color space and digital level go to menu entry PICTURE -> ADVANCED. Set the "digital color space and level" to manual and select your color space and digital drive level.

6.5 Disabling IR receivers

The projector has 3 IR receivers as shown in chapter "4.1 Overview".

These receivers can be individually disabled if necessary. Go to menu entry INSTALLATION > IR FRONT / IR REAR to disable the receivers.

6.6 Controlling screens with triggers

The projector has two programmable triggers with 3.5 mm mini-jack connectors. These can be used to enable or disable screens, curtains or other peripheral equipment.

To change trigger settings, go to menu entry INSTALLATION > TRIGGER

By default:

- Trigger 1 is set to control a screen depending on whether projector is powered on or not.
- Trigger 2 is set to control a screen depending on the aspect ratio of currently active source.

Both triggers can be manually overridden both in the menu system and by using the command and control protocol through RS-232 or LAN.

6.7 Setting aspect trigger behavior

To customize the aspect trigger functionality, go to menu entry INSTALLATION > TRIGGER > ASPECT TRIGGER BEHAVIOR. In this sub-menu it is selectable for which input aspect ratios the trigger will be enabled.

6.8 Automatic power on/off

The projector can be automatically powered on or off by using the internal timer function or DPMS.

6.8.1 Using the timer

The projector features a real-time clock that enables timing control. This means that the projector can be programmed to switch on and off at certain pre-set times during a weekly cycle.

To allow for a flexible schedule, 10 'programs' are available. With each program, you can define the switch on or switch off time for a single day (Monday to Sunday), all work days (Monday through Friday), or week-end (Saturday and Sunday). One, several or all programs can be active at the same time as desired. In this way, a flexible scheme can be established. Observe the 24 hour time format. For more information, see the SETTINGS > TIMER menu.

The following example illustrates a case where the projector turns on at 08:00 in the morning (8 am) and switches off at 20:00 (8 pm) on weekdays (Monday through Friday). Weekends (Saturdays and Sundays), it turns on at 10:00 (10 am) and off at 18:00 (6 pm). VGA is used as the source. For this, four programs are needed, 2 for on and two for off.

6.8.2 Using DPMS (Display Power Management Signaling)

The projector is enabled for DPMS (Display Power Management Signaling). When enabled, the projector will automatically switch to standby mode after a specified time if there is no valid source present at its inputs. When a valid source is reconnected, the projector will start up again.

To enable or disable DPMS, go to menu entry **SETTINGS > DPMS**. The desired DPMS timeout is set in the **DPMS > DPMS TIMEOUT** menu entry.

DPMS is disabled by default.

6.9 Disabling LED indicators

In certain installations it may be desirable to completely disable the LED indicator in the keypad of the projector. To disable the LED indicators, go to menu entry **SETTINGS > LED INDICATORS MUTE**.

If the LED indicators are enabled, the timeout period can be set in the menu under **SETTINGS > BACKLIGHT TIMEOUT**.

6.10 Setting the background color

The background color displayed when the projector is searching for a source can be set to a set of predefined colors. Go to menu entry **SETTINGS > BACKGROUND** to set the desired color. Default is black. Setting OSD menu timeout

If the OSD menu is open and not used for a defined period of time, it will automatically be disabled. The default time is 30 seconds. This timeout interval can be controlled from 5 seconds to 60 seconds. The timeout can also be set to "never" for the OSD menu to never timeout. Go to menu entry **SETTINGS > MENU TIMEOUT** to change this setting.

6.11 Selecting the startup logo

When the projector is starting up, a logo is displayed in the entire image. The logo can also be set to "black" if it is desirable to disable the manufacturer's default logo. Go to menu entry **SETTINGS > SPLASH** to change this setting.

6.12 Setting OSD menu timeout

If the OSD menu is open and not used for a defined period of time, it will automatically be disabled. The default time is 30 seconds. This timeout interval can be controlled from 5 seconds to 60 seconds. The timeout can also be set to "never" for the OSD menu to never timeout. Go to menu entry **SETTINGS > MENU TIMEOUT** to change this setting.

6.13 Selecting the startup logo

When the projector is starting up, a logo is displayed in the entire image. The logo can also be set to "black" if it is desirable to disable the manufacturer's default logo. Go to menu entry **SETTINGS > SPLASH** to change this setting.

7 Optimising the picture

The projector has power features for picture optimization. This chapter describes details in using these features. All color calibration is done using projectiondesign's proprietary RealColor™ solution.

7.1 Calibration data

All projectiondesign projectors are measured and calibrated with high precision equipment at the factory for the best out-of-box experience. Over the lifetime of the lamps the characteristics of the projector might change slightly. The same applies when replacing lamps.

7.1.1 Updating RealColor™ calibration data

For accurate results with the RealColor™ system, accurate measurement data is required.

RealColor™ calibration data can be found under the menu entry PICTURE > CALIBRATION > REALCOLOR CALIBRATION > MEASURED VALUES

X, Y and relative luminance values for red, green, blue, white and BrilliantColor™ 1 is entered in this menu. The BrilliantColor™ should all be set to 0.000 for the VizSim (RGBRGB) color wheel. All values can also be updated using the communications protocol over RS-232 or LAN.

 **Before setting these values, it is important to select the desired BrilliantColor™ setting. Go to menu entry PICTURE > REALCOLOR > BRILLIANTCOLOR to select the desired BrilliantColor™ look.**

Measurements must be done on the built in test patterns. This is in particularly important for the BrilliantColor™ 1 test pattern since it is impossible to generate this pattern correctly using a computer source. In the user menu these patterns can be accessed through PICTURE > CALIBRATION > REALCOLOR CALIBRATION > CALIBRATION TESTIMAGE. Use the arrow keys to cycle through the images.

 **Performing a factory reset of the projector will restore the measured values to the values measured in the factory.**

 **When measuring data, a high quality measurement instrument is highly recommended for accurate results. Spectrometers (like PhotoResearch PR-655) are preferred.**

 **For an easier calibration procedure, automated calibration can be achieved using projectiondesign's software package ProNet. A license for the calibration software package of ProNet must be purchased separately.**

7.2 Working with RealColor™

7.2.1 Setting the BrilliantColor™ correctly

The BrilliantColor™ setting is used to control how color boost is applied in the image. It can operate in four modes:

- Computer Native (Default): This give max brightness and color boost. Recommended for non-video applications, like CAD and visualization.
- Computer Balanced: Gives the same brightness as Computer Native, but has a less aggressive color boost profile.
- Video Native: Gives less brightness than computer, but will appear with significantly less noise in video content.
- Video Balanced: Same brightness as Video Native, but with a smoother color boost profile.
- Off: Only recommend for applications requiring a pure red, green, blue mix of colors. No secondary color or white are added to the mix.

7.2.2 Gamma

The projector features a set of 6 built in gamma curves: Film 2.2, Film 2.8, Video 1, Video 2, Computer 1, Computer 2. The different gamma curves are displayed below.



The names of the curves are descriptive for their recommended use. Use any of the computer curves for video applications will results in significant image noise.

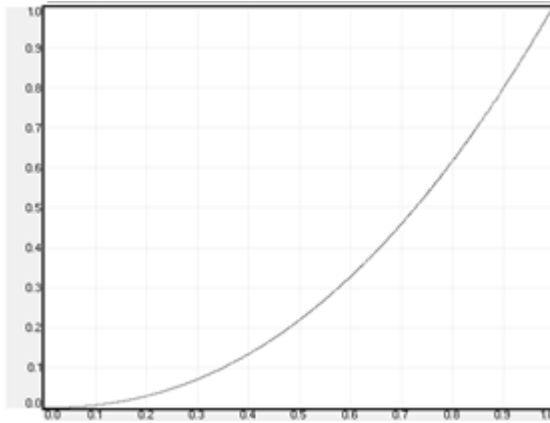

Figure 7-1. Film 2.2 gamma

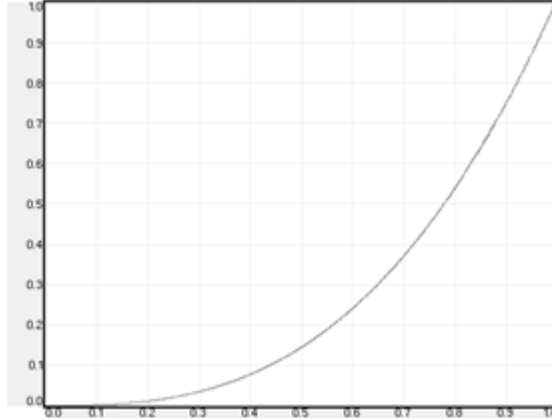

Figure 7-2. Film 2.8 gamma

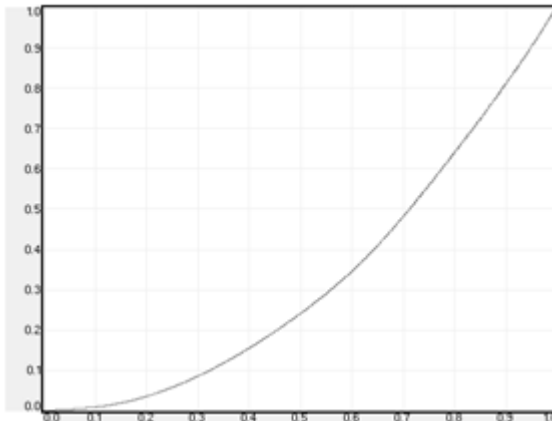

Figure 7-3. Video 1 gamma

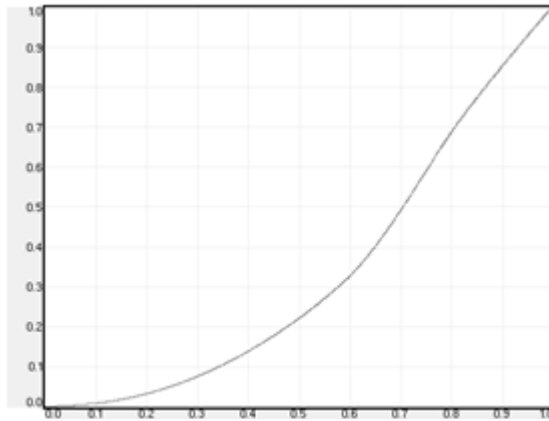

Figure 7-4. Video 2 gamma

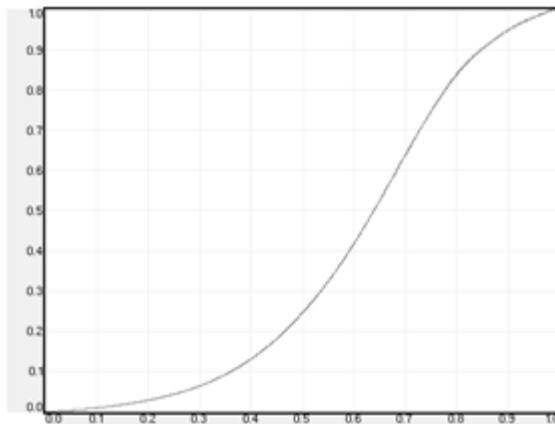

Figure 7-5. Computer 1 gamma

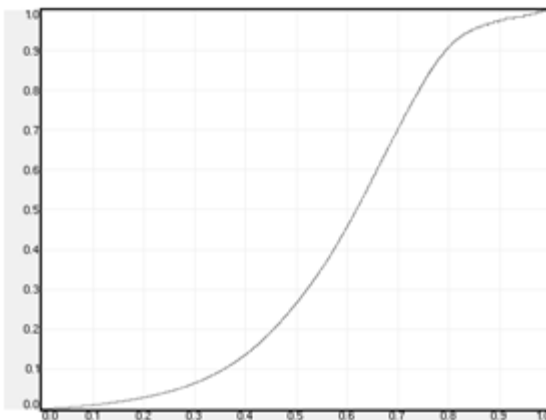

Figure 7-6. Computer 2 gamma

7.2.3 RealColor™ operating modes

Before any color correction is applied to the image, the feature must be enabled. Go to menu entry PICTURE > REALCOLOR > COLOR CORRECTION to enable RealColor™.

RealColor™ can operate in 3 modes:

- Color temperature/white point correction only.
- Red, Green, Blue, White correction. In this mode optimal color coordinates for Cyan, Magenta and Yellow will be computed automatically.
- Red, Green, Blue, Cyan, Magenta, Yellow, White. In this mode color points and intensity for each color can be manipulated separately.

To change the RealColor™ mode, please go the menu entry PICTURE > REALCOLOR > DESIRED VALUES > DESIRED COORDS MODE.

7.2.4 Setting a white point or color temperature

After enabling RealColor™, set the color temperature in the menu entry PICTURE > REALCOLOR > COLOR TEMPERATURE. Values between 3200K and 9300K can be selected. These color temperatures are tracking the “black body curve”- the black curved line in the center of CIE Chart in Figure 7-7. The default is the D65 illuminant at 6500K.

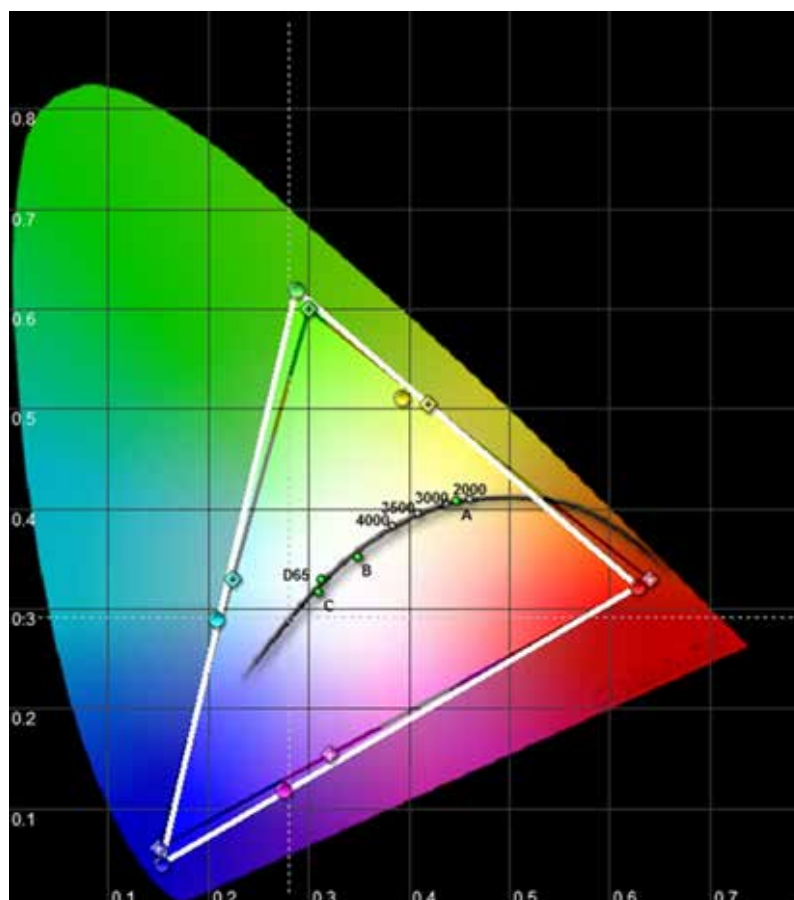

Figure 7-7. CIE Chart with the black body curve

The white point can also be set to a custom value defined by an x, y coordinate not linked to the black body curve. Go to menu entry PICTURE > REALCOLOR > X-COORDINATE and PICTURE > REALCOLOR > Y-COORDINATE to change the white point.

7.2.5 Defining the system color gamut

All colors visible to the eye are defined by CIE Chart in Figure 7-7. The boundary of the colors the projector can display is called the system color gamut. The white triangle in Figure 7-7 is an example of a system color gamut. By default the projector has the widest possible system gamut, which is limited by the color wheel selected for the system. The VizSim color wheel has the widest color gamut and the High Brightness color wheel has the smallest.



The system color gamut cannot be expanded outside color gamut defined by the color wheel.

It may be desirable to change the system color gamut of the projector to:

- Color match multiple projectors.
- Meet defined color standards, like REC 709.
- Create a special “look” to the image.

Before the system color gamut can be change the desired RealColor™ mode has to be defined. To change the RealColor™ mode, please go the menu entry PICTURE > REAL-COLOR > DESIRED VALUES > DESIRED COORDS MODE.

RealColor™ has to be enabled for the desired system gamut to be applied. Go to menu entry PICTURE > REALCOLOR > COLOR CORRECTION to enable RealColor™.

After RealColor™ is enabled and the desired color correction mode is selected, please go the menu entry PICTURE > REALCOLOR > DESIRED VALUES to change the color points to the your desired system color gamut.



For graphical visualization of the system color gamut and easy color management for a single or multiple projectors, the ProNet software package could be used. A license for the calibration software package of ProNet must be purchased separately.

8 Maintenance

8.1 Software upgrades

In order to upgrade your projector, please follow the method and sequence described below.

- You will need a USB memory stick set up with a FAT-file system to perform this upgrade
- Access the upgrade software from the following web-address;
www.projectiondesign.com
- Download and save the firmware.zip-file to your PC desktop
- Unzip and extract the firmware file to the root of a memory stick
PS! Important that the USB is safely removed from computer, using the eject function on your PC.
- Set the projector in standby mode
- Insert the memory stick in the projector and wait for a few seconds
- The LCD display will indicate that it has detected an upgrade file on the memory stick.
Wait a few seconds while the file is validated
- Remove the memory stick when the LCD display instructs you to do so.
- Do not remove the power cord while the upgrade is still in progress
- The projector may restart several times during the upgrade

The upgrade has finished successfully when the ordinary LCD display returns.

Please refer to our website to download the required files or seek other information

8.2 Lamp replacement (UHP units only)

The LAMP indicators on the keypad will turn red when lamp life expires or if the lamp fails.

Change the lamp when lifetime expires. Always replace lamp with the same type and rating. **USE ORIGINAL LAMPS ONLY.**

The lamp includes an electronic lamp timer that is tracking the life time of the lamp.

Allow lamp to cool down before changing. One lamp may be changed while the other lamp is operating (hot-swap).

Release the screw (LAMP 1) or (LAMP 2) depending on which lamp that needs to be replaced.

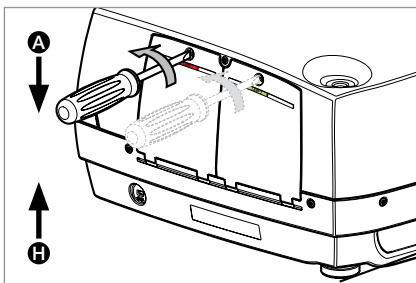

! Be careful not to touch the protective glass when replacing the lamp, this may cause the protective glass to overheat and break while in use.

! Be extremely careful when removing the lamp module. In the unlikely event that the bulb ruptures, small glass fragments may be generated. The lamp module is designed to contain these fragments, but use caution when removing the lamp module.

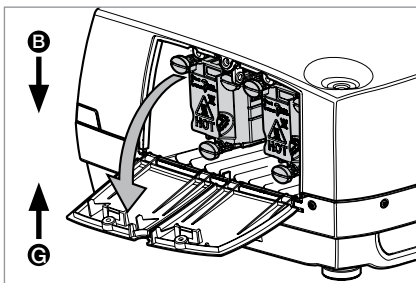

A Open the lamp lid(s).

B Turn the three locking screws a quarter turn anti-clockwise.

C Pull the lamp out.

D Replace with a new lamp in reverse order.

E Insert a new lamp. Observe the guide pins.

F Turn the tree locking screws a quarter turn clockwise.

G Close the lamp lid.

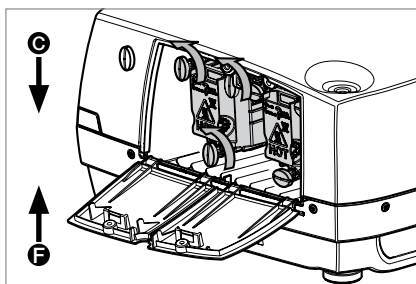

H Turn the locking screw clockwise.

! In the unlikely event of a lamp rapture, a limited amount of mercury vapor may be emitted into the room. To avoid inhaling this mercury vapor (which is toxic, and can be harmful for lungs and nervous system) the room should be thoroughly ventilated for a period of at least 30 minutes. There are no known health hazards from exposure to lamps that are intact and which are used within an enclosed fixture. No adverse effects are expected from occational exposure to broken lamps. As a matter of good practise, avoid prolonged or frequent exposure to lamps unless there is adequate ventilation. The major hazard from broken lamps is the possibility of sustaining glass cuts.

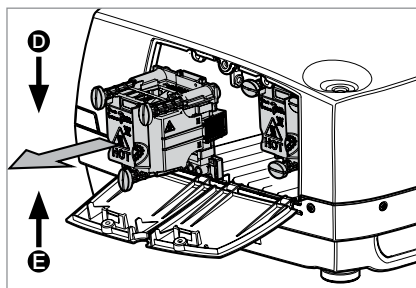

9 Technical specifications

9.1 Product details

technology	single chip DMD™ (Digital Micromirror Device™)
concept	sealed, all-glass optical design with lens shift
available resolutions	WQXGA (2560 x 1600) PANORAMA (2560 x 1080)
connectivity	<i>please refer to section 4.3 Connectivity for complete list</i>
dimensions (dwh)	376 x 510 x 223 mm (ex. lens)
weight	about 12.6 kg (ex. lens)
environmental	RoHS, WEEE
power requirements	8.4A ~100-240V 50-60Hz <1050W power consumption (UHP) <325W power consumption (LED)
BTU/hr	<2750 (UHP) / <1100 (LED)
operating temperature	0 – 40°C / 32 – 104°F, 0 – 1500 m 0 – 35°C / 32 – 95°F, 1500 – 3000 m
conformances	CE, FCC Class A and cCSAus
UHP lamp	2 x 300W UHP™
lamp life	2000/2500 hrs full/eco (5000 hrs in auto switch eco mode*)
lamp part no.	400-0500-00
LED lamp	LED illumination
lamp life	Up to 100000 hours (Full power) Up to 100000 hours (Eco mode)
lamp part no.	n/a

* Option in lamp sub menu: One lamp will be lit at the time and the projector will automatically switch between the lamps in a specified interval (1hr to 24hr).



For a more extensive and up to date overview of technical specifications, please refer to the product page on our home page.

投影机简介

CR series
用户手册



1 本用户手册目录

1	简介	7
1.1	感谢您	
1.2	特征	
1.3	本文中使用的符号	
2	安全说明	9
2.1	安全性	
2.2	常规警告	
2.2.1	关于汞蒸气的相关潜在健康问题的信息和警告（仅适用于超高压汞灯）	
2.2.2	耐用和持续使用（仅适用于超高压汞灯）	
2.2.3	服务人员信息和警告（仅适用于超高压汞灯）	
2.2.4	遥控器警告	
2.2.5	警告标志	
2.3	FCC	
2.3.1	WEEE 信息	
2.4	回收利用	
2.5	服务信息	
2.6	处置信息	
2.6.1	处置信息	
2.6.2	产品中电池的处置	
2.7	服务信息	
3	包装清单	13
4	了解投影机	15
4.1	概观	
4.2	指示灯	
4.2.1	状态指示灯	
4.2.2	键盘	
4.2.3	遥控器	
4.3	连接	
4.4	图形用户界面（GUI）	
5	基本设置	21
5.1	镜头	
5.1.1	镜头和镜头接口	
5.1.1	插入镜头	
5.1.1	更换镜头	
5.2	调节屏幕上的图像尺寸和位置	

- 5.3 灯泡运作
- 5.4 投影机旋转
- 5.5 吊装支架
 - 5.5.1 吊装支架罩（选配）
 - 5.5.1 连接吊装支架罩
- 5.6 连接和电缆
 - 5.6.1 安装视频来源
 - 5.6.2 安装电脑来源
 - 5.6.3 连接命令与控制接口
 - 5.6.4 连接 X-PORT™ 模块
- 5.7 使用 X-PORT™ 模块
 - 5.7.1 X-PORT DCC120
 - 5.7.2 X-PORT 3G-SDI
- 5.8 图像对齐
- 5.9 设置图像取向
- 5.10 使用来源扫描
- 5.11 限定 OSD 消息
- 5.12 更改菜单系统的语言
- 5.13 确定系统状态
 - 5.13.1 获取有关活动来源的信息
- 5.14 使用双灯泡系统（仅适用于超高压型号）
- 5.15 图像尺寸

- 6 高级设置 31
 - 6.1 使用遥控器 ID (RCID) 控制多台投影机
 - 6.2 使用 PIN 码保护投影机
 - 6.3 双屏显示输入
 - 6.4 设置自定义色彩空间和数字电平
 - 6.5 禁用 IR 接收器
 - 6.6 使用触发器控制屏幕
 - 6.7 设置纵横比触发器行为
 - 6.8 自动开机/关机
 - 6.8.1 使用定时器
 - 6.8.2 使用 DPMS（显示能源管理信号）
 - 6.9 禁用 LED 指示灯
 - 6.10 设置背景颜色
 - 6.11 选择启动徽标
 - 6.12 设置 OSD 菜单超时
 - 6.13 选择启动徽标

- 7 优化图片 35
 - 7.1 校准数据
 - 7.1.1 更新 RealColor™ 校准数据

7.2	使用 RealColor™	
7.2.1	正确设置 BrilliantColor™	
7.2.2	伽玛	
7.2.3	RealColor™ 操作模式	
7.2.4	设置白点或色温	
7.2.5	定义系统色域	
8	维护	41
8.1	软件升级	
8.2	灯泡更换（仅适用于超高压汞灯投影机）	
9	技术规范	43
9.1	产品细节	

1 简介

1.1 感谢您

本文所用术语 xxx-系列的说明

在本文中提及术语 xxx-系列时，即表明这部分内容适用于以下 Barco 产品：

- CRPN-52B • CRPN-62B
- CRWQ-62B • CRWQ-72B

感谢您购买这款投影机。

CR 投影机为相同尺寸和性能类别的投影机树立了行业标杆。这款投影机具备高分辨率 DLP 技术、高性能光学元件和镜头、更新的信号处理和内置帧锁相同步，非常适合多通道可视化和仿真应用，在这些应用中现实和可靠性是关键标准。此外，1080p 和 WUXGA 版本具备极佳的图像表现，适合主动立体 3D。

1.2 特征

- 全景 (2560x1080) 或 WQXGA (2560 x 1600) 分辨率单芯片 DLP® 技术
- 专利双结构或 LED 照明系统和镜片
- RealColor 高级色彩管理组件
- 防故障、热插拔双灯结构或长寿命 LED 照明
- 双光机光圈，可供自定义光亮度和对比度
- 配置全功能水平和垂直镜头位移功能，可直接叠放
- 全 12 位颜色清晰度可实现最小失真和高精确度
- BrilliantColor™ 技术，可进行六色处理以获取精确颜色
- 提高了不匹配图像的动态对比度级别
- 适用于大屏幕应用程序的高亮度
- 应用程序特定的色轮选项范围
- 各种投影机镜头
- 多种多样的色彩管理和校准选项
- 内置实时时钟，可用于定时操作
- Sigma Designs™ 技术视频取消隔行扫描并进行处理
- 经济模式，可降低功耗和延长灯泡寿命
- 轻巧并符合人体工程学的封装
- 直接查看状态监视器和灯泡功能指示灯
- 用于任何可能的视频和数据源的多视频和图形输入
- 双连接 DVI (330 MHz)
- HDMI 1.3a
- LAN 和 RS232 用于控制和监控

1.3 本文档中使用的符号



警告：用于指明在使用此产品或外部设备时会对人或设备产生潜在危险。



注意：用于指明投影机的基本操作要求，如果未遵照执行，可能导致产品出故障。



提示：用于对投影机使用或与投影机性能相关的状况提供有益的建议。

本投影机的规格和功能可能有所更改，恕不提前通知。

2 安全说明

本设备符合在办公环境中使用信息技术设备的安全性规定。首次使用设备之前，请仔细阅读安全说明。

2.1 安全性

本用户指南包含有关安全预防措施及安装和使用投影机的重要信息。操作投影机之前请仔细阅读本手册。

2.2 常规警告

仅使用投影机随附的电缆电线或原装更换电缆。
使用其他电缆或电线可能会导致本机故障和永久性损坏。

始终使用三相/接地电源线，以确保设备正确接地。切勿使用两相电源线，因为此类电源线很危险，可能会导致电击事故的发生。

切勿打开本机。本投影机不含任何用户可以自行维修的零件。所有维修工作仅可交由合格的人员处理。请确保无任何物品进入装置的通风口和开口内。

请勿将任何液体溅落到投影机或本机的通风口或开口内。

在打开投影机之前先卸下镜头盖。如果未卸下镜头盖，则可能会被镜头放射的高能量光线融化。融化的镜头盖可能会对投影机镜头表面造成永久性损坏。

请勿在打开投影机时朝投影机镜头里面看。强烈的光线可能对视力造成永久性损伤。请勿直视遥控器上已激活的激光束。激光可能可能对视力造成永久性损伤。

请勿将激光束指向人或动物。

仅可将投影机放置在稳固的表面上，或使用可靠的天花板吊装支架进行安全安装。

请勿摔落投影机。



始终根据旋转指南操作投影机。在其他位置操作本机会极大地降低灯泡寿命，并会导致过热，从而引起故障。

始终允许足够的气流通过投影机。切勿阻塞任何通气口。切勿在本机运行时以任何方式进行覆盖。使本机与墙壁和天花板之间保持足够的距离，以免过热。

本机各个方向的最小安全距离为 50 厘米/20 英寸。

后通风口排放热空气。请勿将热敏物品放置在距离排气口小于 50 厘米/20 英寸的范围内。

本投影机仅限于室内使用。切勿在室外操作本机。

请勿在超出投影机温度和湿度规格的环境中进行操作，因为这可能导致机器过热并发生故障。

将输入源连接到已通电的投影机可能导致产品发生故障。建议将电源线连接器（投影机端）或主电源插座放置在易接近的位置，以便在连接输入源设备时可方便地断开或关闭电源。在产品安装时就应考虑到这种情况。

仅将投影机连接到技术规范中所述的信号源和电压。若连接到非指定的信号源或电压，可能导致本机发生故障并造成永久性损坏。

为了防止由于过压（如闪电）而对投影机造成损坏，我们建议将投影机连接至具备过压保护的线路（干线）。

待灯泡冷却之后再更换。可在使用另一个灯泡的同时更换灯泡（热插拔）。只能使用原装灯泡。

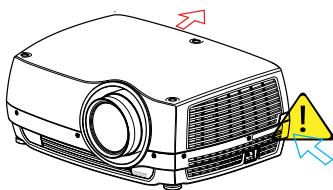

2.2.1 关于汞蒸气的相关潜在健康问题的信息和警告（仅适用于超高压汞灯）

本投影机使用大功率 UHP™ 灯泡进行照明，以产生极其明亮的图像。

此技术与现今汽车、街灯和其他照明电器中广泛应用的其他高压放电管类似。这些灯泡（如荧光灯）含有少量的汞。灯泡中的汞含量远远低于危险限制范围。正确处理含汞灯泡，从而最大限度地降低潜在健康危害，这一点十分重要。

与其他高光亮度投影机灯泡一样，UHP™ 灯泡在运作时将处于高压之下。虽然灯泡和投影机经过巧妙设计，可最大程度降低灯泡破裂的可能性，但灯泡在运作时仍可能破裂，并且投影机中可能会放射出少量的汞蒸气。当灯泡达到其预期使用寿命时，破裂的可能性将增加。因此强烈建议您更换达到额定寿命的灯泡。

作为一般预防措施，请确保投影机运行时室内通风良好。如果灯泡发生破裂，请撤离房间并确保良好通风。特别是儿童和孕妇更应离开房间。

通过正确回收利用来仔细处理使用过的灯泡。

汞是一种自然产生、稳定的金属元素，在某些情况下可能存在安全风险。根据有毒物质和疾病登记署（“ATSDR”，美国公共卫生署的一个部门）发布的针对汞使用的公共健康声明，大脑、中枢神经系统和肾脏容易受到汞的影响，暴露在高浓度的汞蒸气中可能会造成永久伤害。急性接触高浓度的汞蒸气可引起诸如肺癌和呼吸道刺激、胸闷、肺部烧灼感、咳嗽、恶心、呕吐和腹泻等症状。在金属汞对神经系统的有害影响方面，儿童和胎儿尤其敏感。

如果灯泡破裂后发生上述任何症状，或者发生其他不寻常症状，请送医治疗。

2.2.2 耐用和持续使用（仅适用于超高压汞灯）

投影机包含具有有限预期寿命的移动零件（如冷却风扇）。当投影机使用 8000 小时后，当投影机在关键任务应用中使用时，建议由合格的服务人员定期检修。当投影机需要预防性检修时，屏幕上会显示一条消息。这将有助于确保长期稳定的操作。

2.2.3 服务人员信息和警告（仅适用于超高压汞灯）

在维修过程中，使用防紫外辐射的眼睛和皮肤保护设备。

2.2.4 遥控器警告



激光辐射 2 级产品；波长为 670nm；最大输出功率为 1mW。

遥控器符合 21 CFR 1040.10 和 1040.11 的适用要求。







遥控器符合 EN/IEC 60825-1/2007 的适用要求。



采取本用户指南说明之外的控制、调整或执行步骤可能导致危险的辐射暴露。

2.2.5 警告标志

下面是产品标签上找到的警告标志列表：

-  阅读用户手册注意事项！请阅读用户指南获取更多信息！
-  危险电压危险示意！产品内含高压电！
-  高温警告！热表面！
-  等待警告！等待，直至冷却！
-  汞警告！灯泡含汞！适当回收利用，请勿按照普通废物处理方式进行处理！
-  紫外线警告！产品内含紫外线辐射！
-  回收利用警告！适当回收利用，请勿按照普通废物处理方式进行处理！

2.3 FCC

在 FCC 规定中，任何未经制造商责任方明确批准的更改或修改，都将导致用户使用本设备的权利失效。



此设备经测试证明符合 FCC 规则第 15 部分中 A 级数字设备的限制规定。这些限制旨在对设在商业环境的设备所发出的有害干扰提供合理保护。本设备会产生、使用及发出射频能量，如不按照说明安装及使用，可能对无线电通信造成有害干扰。在住宅区操作本设备可能导致有害干扰，在此情况下将要求用户自费消除此干扰。

本设备符合 FCC 规则第 15 部分的规定。须在以下两种条件下操作：

- (1) 本设备不会造成有害干扰，且
- (2) 本设备必须能承受任何干扰，包括会造成意外操作的干扰。

加拿大

本 A 级数字设备符合加拿大 ICES-003 规定。/ Cet appareil numérique de la classe A est conforme à la norme NMB-003 du Canada.

警告



本产品为 A 级产品。在住宅环境中，本产品可能导致无线电干扰，在此情况下将要求用户采取足够的措施。

2.3.1 WEEE 信息

本产品符合欧盟对于报废电子电气设备 (WEEE) 指令的所有要求。应正确回收利用本产品。它可以拆卸，以便正确回收利用各零件。本投影机使用的投影机灯泡应正确加以回收利用。关于收集 WEEE 的收集点，请咨询您的经销商或相关公共机构。

2.4 回收利用

本产品含有加州当局已知可导致出生缺陷或生殖系统受损的化学成分（包括铅）。适当回收利用，请勿按照普通废物处理方式进行处理！

2.5 服务信息

此产品不含任何用户可以自行修理的零件。如果产品无法按预期操作，请首先检查是否已正确连接了所有零件，然后检查电源线是否正确连接。请检查全部打开了投影机以及视频和电脑来源。电缆和电线可能随着时间流逝破损。如果连接不良或断断续续，请尝试更换电缆和电线。请检查断路器和干线的保险丝是否完好无损。如果产品出现故障，请联系您的经销商。您应该准备对所遭遇的故障症状的说明。此外，请说明投影机底部标签上打印的产品编号和序列号。

2.6 处置信息

2.6.1 处置信息

报废电子电气设备



产品上的这个标志表明，根据适用于电子电气设备报废的欧洲指令 2002/96/EC 的规定，此产品不准与其他城市垃圾一起处置。处置您的报废设备时，应将它交到专门回收利用报废电子电气设备的指定回收点。为了防止由于不受控制的废物处理而对环境或人类造成危害，请将这些报废设备与其他类型的废弃物分开处理，并负责地对它们进行回收利用，从而促进物质资源的可持续性重复利用。

有关此产品回收利用的更多信息，请联系当地市政府办公室或城市废物处理服务部门。

欲知详情，请访问 Barco 网站，网址为：

<http://www.barco.com/en/AboutBarco/weee>

2.6.2 产品中电池的处置



此产品所含电池受指令 2006/66/EC 的管制，必须与城市垃圾分开收集和处置。

如果电池所含铅 (Pb)、汞 (Hg) 或镉 (Cd) 超过规定值，则这些化学符号将显示在打叉带轮垃圾桶符号下面。

通过参与电池分类收集活动，有助于确保电池得到妥善处置，以及防止对环境和人类健康产生潜在的负面影响。

2.7 服务信息

此产品不含任何用户可以自行修理的零件。如果产品无法按预期操作，请首先检查是否已正确连接了所有零件，然后检查电源线是否正确连接。请检查全部打开了投影机以及视频和电脑来源。电缆和电线可能随着时间流逝破损。如果连接不良或断断续续，请尝试更换电缆和电线。请检查断路器和干线的保险丝是否完好无损。如果产品出现故障，请联系您的经销商。您应该准备对所遭遇的故障症状的说明。此外，请说明投影机底部标签上打印的产品编号和序列号。

3 包装清单

以下组件是标准配置：

投影机



电源线（不同国家/地区的电源线有区别）



遥控器



用户文档



投影机的其他配件：

DVI 线缆



在拆开包装时，请确认所有组件和配件均包含在包装内。查看下一页以了解包装内包含的其他附件。



如果以后需要装运投影机，请保留包装材料以备将来使用。

4 了解投影机

4.1 概观

- A 镜头
- B IR 传感器
- C1 通风口 - 空气流入
- C2 通风口 - 空气流出
- D 镜头释放钮
- E 电源连接器
- F 键盘
- G 连接器面板
- H LCD
- I 灯泡盖*
- J 可调式支脚
- K 防盗锁
- L 吊装支架



图 4-1. - 投影机前视图



图 4-2. - 投影机后视图

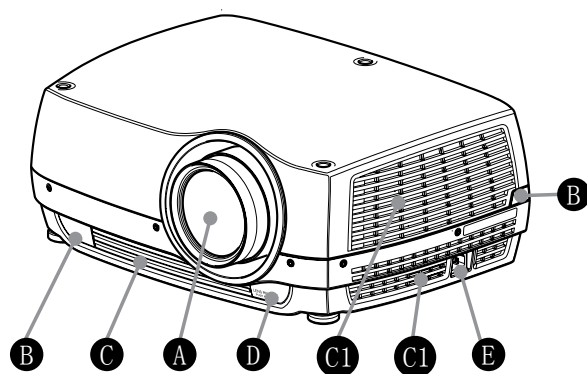

图 4-3. - 投影机底视图

* 由于型号/版本不同，用户手册配图/插图中显示的产品特征可能与您的投影机上的实际情况存在差异。

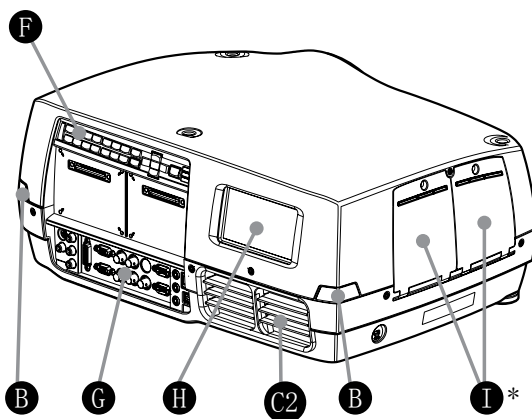
4.2 指示灯

系统状态指示灯位于投影机背面的键盘右侧。图 4-4 显示三个状态指示灯 - 两个灯泡各有一个指示灯，另一个是系统状态指示灯。

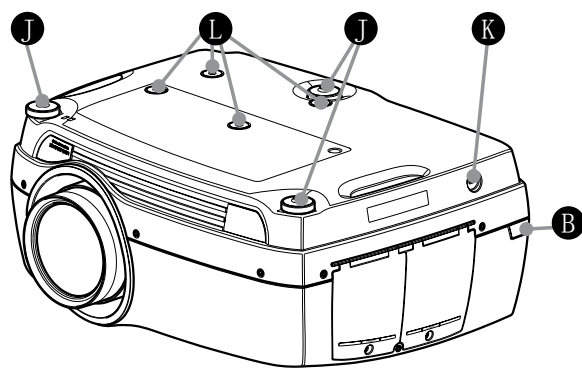

* 图片显示配有超高压汞灯的投影机背面板。
LED 照明投影机只有一个指示灯 (LED)，而不是两个 (LAMP 1、LAMP 2)。

图 4-4. 灯泡指示灯

灯泡指示灯的状态如下所示：

- 常亮绿灯：灯泡点亮且正常工作。
- 常亮黄灯：灯泡关闭。灯泡可能已在菜单中设置为禁用，或者系统处于待机状态。
- 常亮红灯：灯泡寿命已过期、灯泡未亮起或灯罩处于打开状态。如果灯泡寿命已过期，请立即更换投影灯泡。不更换灯泡可能导致灯泡爆炸。请使用原装 projectiondesign 替换用灯泡来替换。
- 闪烁黄灯：灯泡正在冷却。总计冷却时间大约为 45 秒。
- 没有显示任何灯：未插入灯泡。

! 替换用灯泡必须从授权 projectiondesign 经销商处购买，否则产品保修将无效。使用来自任何其他售后市场供应商的灯泡将使产品保修无效。

4.2.1 状态指示灯

- 常亮绿灯：投影机已打开并且运作正常。
- 常亮黄灯：投影机处于待机模式。如果投影机是由节电功能 (DPMS) 关闭的，则当您连接有效来源时它将自动打开。
- 闪烁黄灯：请等待。在连接电源线后，黄灯将闪烁 20-30 秒，进入待机模式片刻后灯泡开始冷却时，黄灯将闪烁约 45 秒。在灯变为常亮黄色之前，不得再次打开投影机。
- 闪烁红灯：投影机过热。立即关闭！检查通风口是否被覆盖或者周围温度是否超出规定。除非电源线切断并重新连接，否则投影机无法重新启动。如果投影机继续闪烁红灯，则需要将本机返修。

4.2.2 键盘

投影机的背面配有可发光键盘。图 4-5 显示键盘。



图 4-5. 投影机键盘

* 图片显示配有超高压汞灯的投影机背面板。
LED 照明投影机只有一个指示灯 (LED)，而不是两个 (LAMP 1、LAMP 2)。

键盘用于：

- 导航菜单系统
- 滚动 LCD 面板中的信息
- 直接选择输入源
- 输入 PIN 码（如果启用）
- 开机/关机
- 调节基本图像功能

键盘可发光以便在黑暗的环境中运作。可用功能以黄色光表示，已选（激活）功能以绿色光表示。不可用功能无亮光。

4.2.3 遥控器

遥控器允许通过直接键或菜单系统灵活访问投影机设置。背光式遥控器可在黑暗环境中使用。此外，它还具有一个数据插孔，允许通过有线方式连接到投影机。连接导线后，IR（红外线）光束和内部电池将关闭。

! VGA1、VGA2、X-Port 2 和 YPbPr 的直接来源按钮并非适用于产品的所有版本。如果您的产品无法实现这些输入功能，则在按下这些按钮时 OSD 将显示“不适用”。



! 请勿直视遥控器上已激活的激光束。激光可能对视力造成永久性损伤。避免将激光束指向人或动物。

! 仅使用随附的遥控器，否则可能会出现故障。

图 4-6. 遥控器

4.3 连接

该投影机配备各种视频输入和命令/控制连接器。
图 4-7 显示连接器面板。



图 4-7. 连接器面板

- A LAN: 10/100 Mbit 以太网连接器用于命令、控制和软件升级。
- B RC 输入: 3.5mm 微型接口连接器。允许连接外部 IR 接收器或有线遥控。
- C 触发器: 3.5mm 微型接口连接器触发器。用于控制外部设备 (如电动幕)。
- D ----
- E RS-232: 允许有线遥控和监视安装环境中使用的众多投影机功能。
- F USB-A: 允许使用标准 USB 记忆棒执行软件升级。
- G USB-B: 保留以供将来使用。
- H 同步输入: 允许获取外部垂直同步信号并与所选视频输入一起使用。这主要用于需要在多台投影机之间保持视频同步的情况。
- I 同步输出: 持续输出有效视频输入的垂直同步信号。这主要用于需要在多台投影机之间保持同步的情况。
- J DVI-D: 两个双连接 DVI-D 连接器, 总计带宽高达 330 Mhz。可通过将图像的一半分别输送到这两个连接器, 然后组成一张统一的图像。符合 HDCP, 用于高达 165 Mhz 的来源。
- K VGA: 两个 VGA 连接器, 带宽高达 170 Mhz。
- L YPbPr: 模拟视频输入, 支持高达 1080i 的 YPbPr 和 RGB (绿同步) 视频标准。
- M HDMI 1.3: 两个 HDMI 1.3a 连接器, 每个带宽高达 165 Mhz。可通过将图像的一半分别输送到这两个连接器, 然后组成一张统一的图像。符合 HDCP。HDMI 1.3a 指定的所有视频格式均受支持。

4.4 图形用户界面 (GUI)

投影机有一个易用的屏幕显示 (OSD) 系统, 用于控制大量的功能实现。图 4-8. 顶层 OSD 菜单 显示 OSD 菜单的顶层菜单。

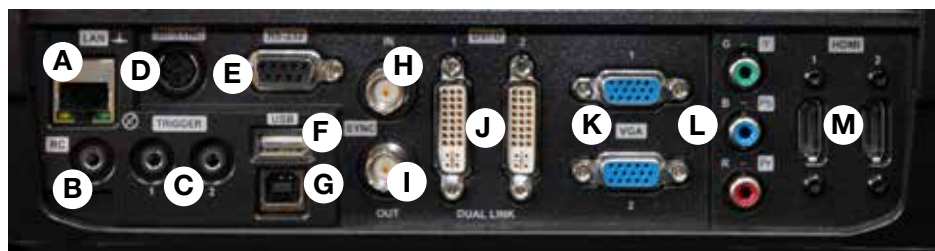

图 4-8. 顶层 OSD 菜单

按下键盘或遥控器上的“MENU (菜单)”按钮激活菜单。使用箭头键导航菜单。OSD 菜单中的各种功能在第“5 Basic setup”章介绍。

5 基本设置

5.1 镜头

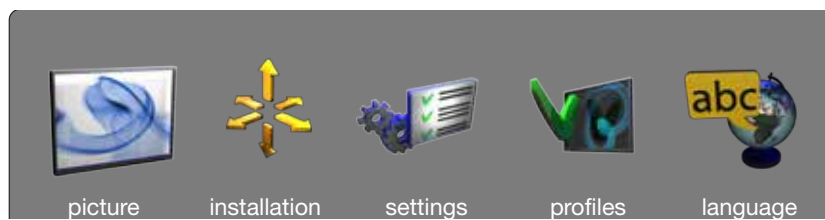
5.1.1 镜头和镜头接口

提供各种固定及变焦镜头，可涵盖大部分应用（前投影和背投影）。镜头配有插刀式接口，便于安装。



安装之前请关闭所有设备，以使本机正常运作。

安装和更换镜头时，要注意只要镜头未连接到系统，光学系统就可能暴露在尘土和异物中。打开镜头接口的时间不得超过更换镜头所需的时间。在未安装镜头的情况下，应始终插入护盖以免尘土和异物进入内部光学系统。



切勿在未安装镜头的情况下运行投影机。

5.1.1 插入镜头

如需插入镜头，请遵循以下步骤：

- A 通过反向旋转旋钮从插刀式接口卸下护盖。
- B 卸下后镜头盖。
- C 使用插刀式接口连接投影机镜头，同时观察红色插入标记。
- D 顺时针方向用力旋转镜头，直至镜头“咔”的一声停止旋转。
- E 从投影机镜头上卸下镜头盖。如果在未卸下镜头盖的情况下打开投影机，则镜头盖可能被融化，这不仅会损坏镜头盖，还会损坏投影机镜头和周围零件。

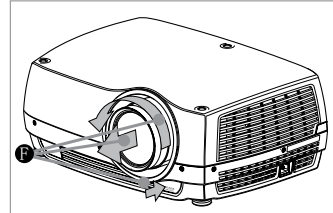
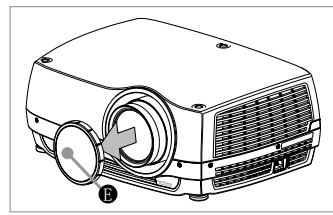
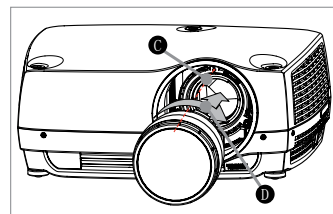
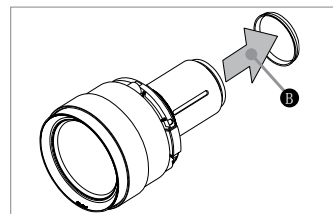
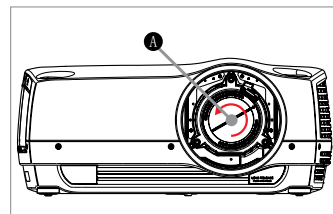

5.1.1 更换镜头

如需更换镜头，请遵循以下步骤：

- A 要更换镜头，首先通过按下释放钮并反向旋钮镜头直至其松动为止，卸下当前的镜头。将镜头拔出。
- B 按上述说明插入新镜头。

5.2 调节屏幕上的图像尺寸和位置

调节屏幕上的图像布置可通过以下方法完成：

1. 可调式支脚（图 5-1 中的 E）。
2. 通过键盘、遥控器、RS-232 或 LAN 进行控制的镜头位移机械装置（图 9 中的 A）。
3. 通过键盘、遥控器、RS-232 或 LAN 进行控制的镜头变焦（适用于带变焦的镜头）（图 5-1 中的 B）。

找到适合的图像尺寸和位置之后，请使用键盘、遥控器、RS-232 或 LAN 调节图像焦点。（图 5-1 中的 C）。



图 5-1. 图像尺寸和位置调节

5.3 灯泡运作

投影机配有两个独立投影灯泡*，可以在各种模式下运作。此外，灯泡可以根据需要单独更换。这确保购买成本最优化。每个灯管均配有各自的灯管定时器。

灯泡运作模式在“安装 > 灯泡”子菜单中进行控制。

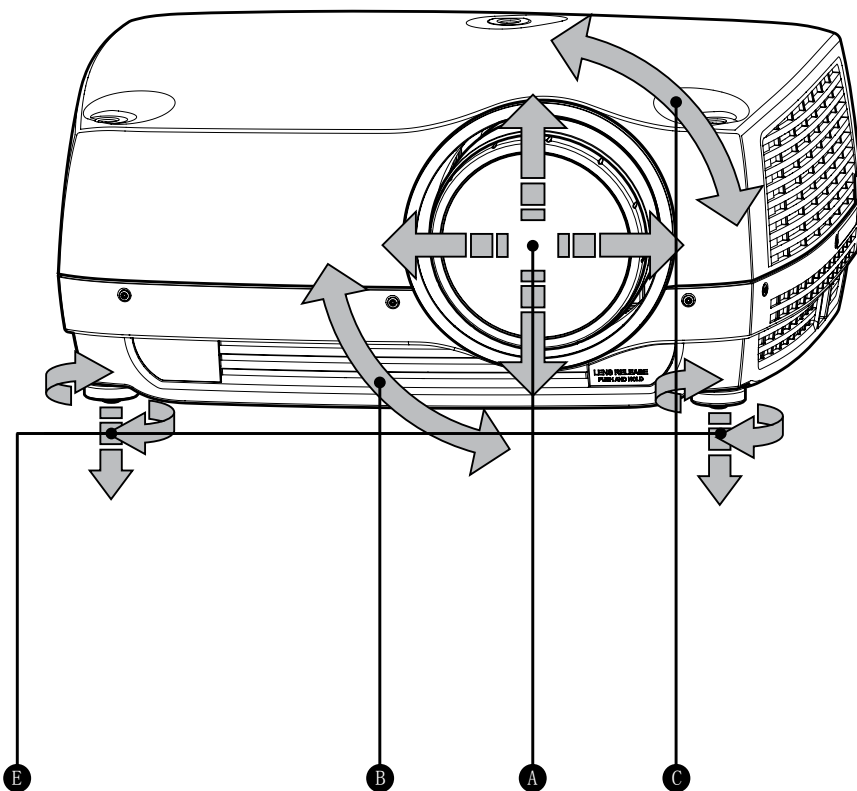
* 仅适用于超高压汞灯投影机。LED 投影机只有一个灯泡。

5.4 投影机旋转

始终在可调整的前后底脚范围内水平操作投影机。投影机可以旋转，以使镜头点降低。不得围绕穿过镜头的轴进行旋转。

在其他位置操作本机可能会极大地降低灯泡寿命，并会导致过热，从而引起故障。

5.5 吊装支架



投影机可使用许可的 UL 测试/列出的吊装支架安装在天花板上，该支架最低可支撑 60 千克/130 磅。使用 M6 螺钉将吊装支架穿进投影机主机，最多可穿进 15 毫米/0.6 英寸。图 5-2. 吊装支架 显示了投影机中的吊装支架螺钉孔的详细对准信息。



从天花板/后墙到适当的通风口的最小距离应为：
30/50 厘米，12/20 英寸。



图 5-2. 吊装支架

5.5.1 吊装支架罩（选配）

投影机进行吊装支架安装时，选配的辅助电缆盖可安装在投影机上以掩盖接口电缆和电源线。在将电缆盖连接至投影机前，请连接所有的电缆并将它们固定好。图 5-3 显示了吊装支架罩。

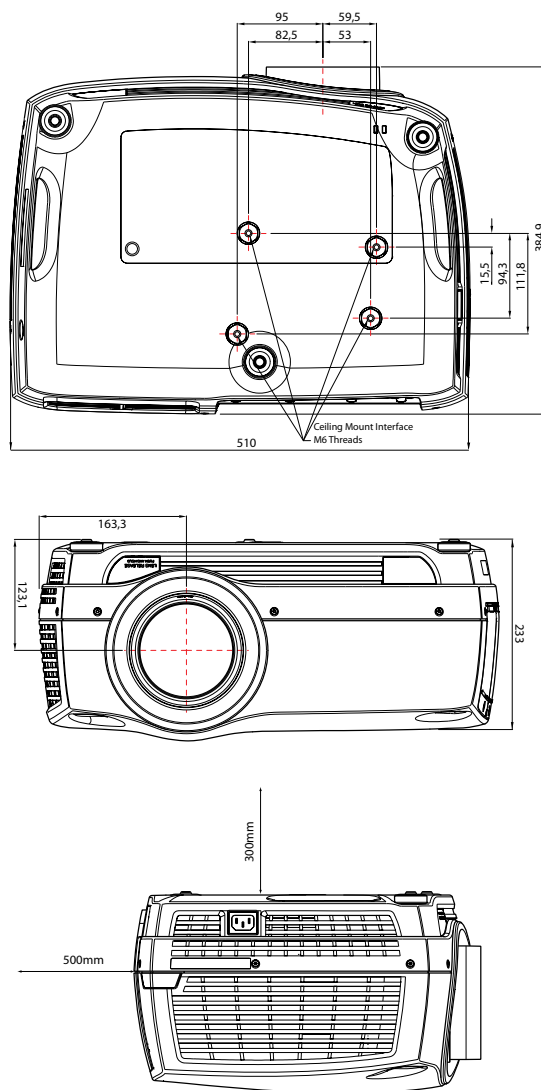

图 5-3. 吊装支架罩

5.5.1 连接吊装支架罩

如需连接吊装支架罩，请遵循以下步骤：

- A 通过在投影机后部的水平插槽中插入横钩，将电缆盖连接至投影机。
- B 旋转盖子直到盖子上的垂直钩插入投影机后部的垂直插槽。
- C 盖子会自动打开或关闭，从插槽中拔出盖子上的垂直钩，使盖子成为横钩的合页。

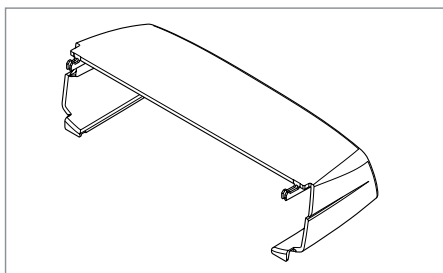
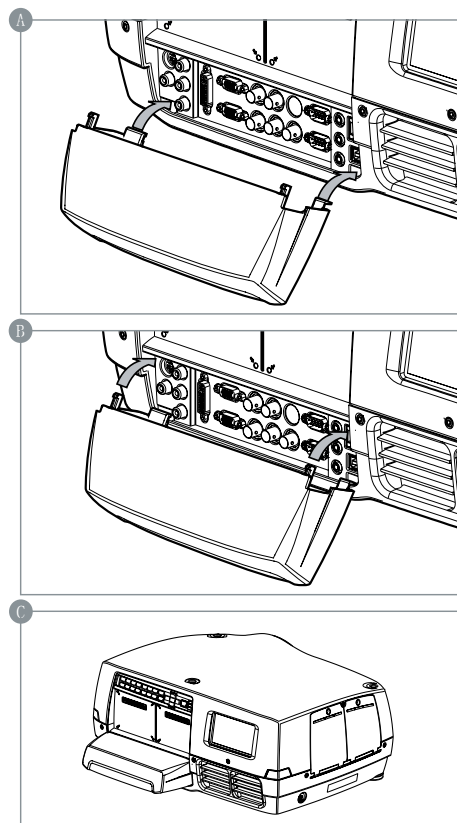

5.6 连接和电缆

! 在安装之前，请关闭所有设备并断开电源线。为了防止由于过压（如闪电）而对投影机造成损坏，请在安装时连接至具备过压保护的线路（干线）。

5.6.1 安装视频来源

为获得最佳品质的视频，请使用 HDMI 1.3a 接口 (O) 连接数字视频来源，如 图 5-4 中的连接视频来源 所示。HDMI 输入符合 HDCP 复制保护。如电缆质量足够好，投影机可支持使用长达 20 米（65 英尺）的电缆。



图 5-4. 连接视频来源

5.6.2 安装电脑来源

使用如 图 5-4/图 5-5 中所示的 HDMI (O)、DVI-D (J) 或 VGA (K) 接口，该投影机可同时连接多达六个电脑来源。数字接口 (DVI/HDMI) 将生成噪音极低的投影图像。DVI 和 HDMI 均符合 HDCP，可使用高达 1920x1200@60Hz（单链接源高达 165 Mhz）的来源。使用 3G-SDI、DisplayPort 1.1a 和 HDMI 3D（请参见单独章节）等附加 X-PORT 连接器可实现附加功能。



图 5-5. 连接电脑来源

! 更高分辨率来源（如 2560x1600@60Hz (WQXGA)）不支持 HDCP。
正确接入其他电缆之后再连接电源线。

5.6.3 连接命令与控制接口

该投影机支持 RS-232 和 LAN 命令与控制接口。使用基于 ASCII 的协议与投影机通信。ASCII 协议的详细说明可在 www.projectiondesign.com 下载。正确接入命令与控制电缆之后再连接电源线。



图 5-6. 连接命令接口

5.6.4 连接 X-PORT™ 模块

! X-PORT™ 模块需单独购买，未包括在基本投影机内。

! 在连接 X-PORT™ 模块之前先关闭投影机并断开电源线。在连接任何 X-PORT 模块之前，请确保已拥有在投影机上运行的最新软件。请转至 www.projectiondesign.com 网站下载最新软件并相应地更新投影机。参见第 8 章，了解有关如何升级投影机软件的详细信息。

该投影机支持同时使用两个 X-PORT™ 模块：

- X-PORT™ 1 用于附加图像处理 (X-PORT™ DCC120*)。左侧。
- X-PORT™ 2 用于附加连接 (X-PORT™ 3G-SDI、X-PORT™ DisplayPort 1.1a 和 X-PORT™ HDMI 3D*)。右侧。

*X-PORT™ 模块视情况而定。

如需连接 X-PORT™ 模块，请遵循以下步骤：

- A 旋开四个螺钉，卸下盖板。
- B 连接模块。请注意，X-PORT™ 1 和 2 的位置不同。将 X-PORT™ 模块连接到错误的位置将导致模块不起作用，但不会造成损坏。
- C 将四个固定螺钉牢固地固定好。

* 由于型号/版本不同，用户手册配图/插图中显示的产品特征可能与您的投影机上的实际情况存在差异。

最后接上电源线并开启投影机。



! 在连接模块后首次开启时，投影机将自动更新和配置模块。这可能几分钟。请确保在此期间不断电。

5.7 使用 X-PORT™ 模块

X-PORT™ 模块为投影机带来额外功能。这包括更多连接和附加的图像处理能力。

还可能包括扩展连接（如 3G-SDI 和 HDMI 3D）和附加 3D 格式支持（如蓝光帧封装、双路输入源、双倍闪烁 3D 等）功能。



请参阅第 6.4 章，了解有关多通道 3D 同步的信息。

5.7.1 X-PORT DCC120

X-PORT DCC120 是一个 X-PORT 1 模块（后期处理），为系统增加附加的 3D 能力和多投影机同步功能。

5.7.2 X-PORT 3G-SDI

X-PORT 3G-SDI 模块是一个 X-PORT2 接口模块，可支持所有 SDI、HD-SDI 和 3G-SDI 格式。

5.7.2.1 连接

参数	值
主要连接器	2xBNC-F 输入 A1, 输入 B1
剩余连接器	2xBNC-F 输入 A2, 输入 B2
视频格式	- SDI (SMPTE 259M, 高达 360 Mbps) - HD-SDI (SMPTE 292M, 高达 1.485 Gbps) - 3G-SDI (SMPTE 424M/425M, 高达 3.0 Gbps)
额定阻抗	75 欧姆
扫描格式	隔行或逐行
回波损耗	<-15 dB, DC @ 1 MHz 至 1.5 GHz
时钟频率	高达 3 Gbit/s (3G-SDI)
最大分辨率	1920x1080p@60Hz

5.7.2.1 电缆长度

参数	值
3G-SDI	最长 100 米 (RG-5 18 AWG/1694A)
HD-SDI	最长 110 米 (RG-5 18 AWG/1694A)
SDI	最长 400 米 (RG-5 18 AWG/1694A)

5.8 图像对齐

为了让投影机的校准更容易，测试图像已内置在系统中。

如需启用测试图像，请转至菜单项“安装 > 测试图像”。使用箭头键循环浏览各个测试图像。找到匹配您的屏幕的纵横比的测试图像时，使用变焦、聚焦、镜头位移和物理投影机校准来匹配屏幕。

5.9 设置图像取向

针对屏幕，投影机支持以下安装方向：

- 桌面前投（默认）
- 天花板前投
- 桌面前投
- 天花板后投

如需设置图像取向，请转至菜单项“安装 > 图像取向”

5.10 使用来源扫描

该投影机可自动扫描所有输入连接器以找到有效信号。如果找到有效信号，则会生成图像。这称为来源扫描。

来源扫描默认为禁用。当禁用时，投影机将只搜索所选的输入连接器以查找有效信号。使用键盘、遥控器或任何命令与控制接口来更改所选输入接口。

如需设定来源扫描设置，请转至菜单项“安装 > 来源扫描”

5.11 限定 OSD 消息

在检测来源及使用投影机的各种功能时，屏幕上将显示 OSD 消息。显示的那些消息可由用户部分控制。OSD 可在以下模式下运行：

- 打开。显示所有消息、警告和信息 OSD。
- 关闭。不显示任何消息。
- 仅警告。仅显示关键警告消息（如超温）。

转至菜单项“安装 > OSD 启用”以控制 OSD 行为。

5.12 更改菜单系统的语言

投影机菜单系统内含总共 11 种可选语言，便于在全世界使用。默认语言是英语。

可用语言为：

- 英语
- 法语
- 德语
- 西班牙语
- 俄语
- 挪威语
- 瑞典语
- 韩语
- 日语
- 简体中文
- 繁体中文

- 葡萄牙语
- 意大利语

如需更改菜单系统的语言，只需从顶部菜单选择“语言”，然后选择所需的语言。

5.13 确定系统状态

为了方便使用，投影机有一个完整的菜单用于显示系统状态。可从顶部菜单方便地访问该菜单。在此菜单中可读取以下信息：

- 产品型号
- 序列号
- 投影机的制造年份/星期
- 当前软件版本
- 两个灯泡的运行时间和剩余时间
- 总运转小时数
- 所有网络信息
- 当前安装的镜头
- 当前活动来源

5.13.1 获取有关活动来源的信息

选择“状态 > 来源信息”菜单项，即可显示有关当前活动来源的基本信息。

如果需要对当前活动来源执行更深入分析，请选择“状态 > 来源信息 > 高级”。此菜单显示当前活动来源的详细时序信息。

5.14 使用双灯泡系统（仅适用于超高压型号）

投影机配有两个独立投影灯泡*，可以在各种模式下运作。

5.15 图像尺寸

2560 x 1600 (WQXGA) / 2560 x 1080 (全景)

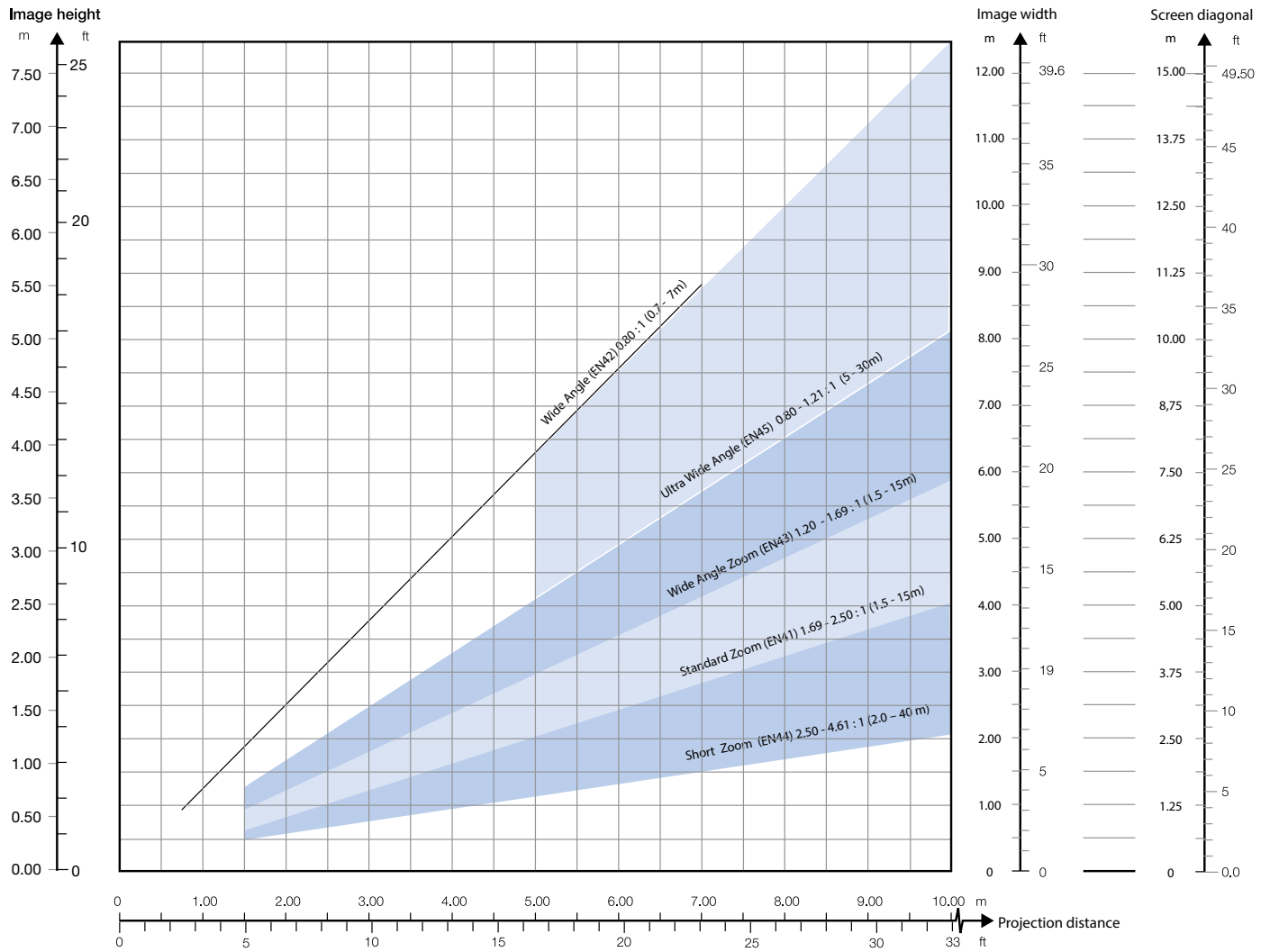

6 高级设置

6.1 使用遥控器 ID (RCID) 控制多台投影机

遥控器可以在“广播模式”或“个体模式”下运作。当多个投影机在一个装置中使用，单独控制会很方便。单独控制可使用数据插孔进行有线遥控，也可以使用单独数字代码进行控制。对于单独控制，首先使用投影机菜单系统设置单个 RC ID 代码，请查看“设置”子菜单。然后，要选择特定的投影机进行控制，首先按键盘区下方的“*”按钮，然后输入在目标投影机中设置的代码。代码范围可介于“0” - “99”之间。“0”保留用于广播。要选择另一个目标，通过按“*”重复该过程并输入新代码。要退出单独控制，按“*”“*”两次或按“*”和“0”。

6.2 使用 PIN 码保护投影机

投影机可使用 PIN 码（个人识别码）控制。PIN 码有 4 位数字，如果激活 PIN 码，则您必须输入正确的代码才能解锁投影机。出厂设置 PIN (1234)。

要激活、取消激活或更改 PIN 码，请转至“设置 > PIN 码”子菜单。



如果输入了错误的 PIN 码，您可以再尝试两次。
如果您连续三次输入了错误代码，则需要 PUK（解锁）。
本产品提供 PUK 代码。



正确输入 PUK 代码是客户的责任。

如果 PUK 代码输入也失败了三次，则投影机将永久锁定，只能由特殊服务解锁代码解锁。

要获得此代码，您将需要联系经销商或维修站。服务解锁代码将根据投影机自身产生的安全加密数字生成。投影机每次都将产生新的数字。



要解锁投影机，客户必须提供所有权证明。

6.3 双屏显示输入

该投影机支持双屏显示输入模式，适合扩展灵活性以连接像素时钟超过 165 MHz 的高分辨率源。在此模式下，图像的左半部分和右半部分可分别连接到 DVI 1/DVI 2 或 HDMI 1/HDMI 2 接口

(图 6-1)。



要启用此模式，请转至菜单“安装 > 双屏显示设置”。这个时候“并排显示”是唯一可用的选项。



图 6-1. 双路输入模式

下面是这种模式的一个示例：使用 960 x 1200 - 120Hz 的来源分辨率在每个 DVI 接口上传输 WUXGA (1920 x 1200) 120Hz 源。

当启用此模式时，每个 DVI 连接器上的 EDID 数据将自动从 WUXGA (1920 x 1200) 120Hz 变化为 960 x 1200 - 120Hz。

-  对于在此模式下显示的图像，两个连接器上的分辨率必须完全相同。
-  在此模式下，两个连接源必须拥有完全一样的时序。如果输入之间的时序存在偏差，将导致在图像的中心出现明显的裂痕。
-  有些图形卡在检测从单屏到双屏模式的变化时会出问题。如果存在问题，请先断开信号电缆，然后在菜单中启用或禁用双屏显示模式。

6.4 设置自定义色彩空间和数字电平

投影机将根据来源信息自动尝试设置正确的色彩空间和数字激励电平。

要手动改写自动检测的色彩空间和数字电平，请转至菜单项“图片 -> 高级”。将“数字色彩空间和电平”设置为手动，然后选择您自己的色彩空间和数字激励电平。

6.5 禁用 IR 接收器

该投影机配有 3 个 IR 接收器，如“4.1 Overview”章节所述。

如有必要，这些接收器可单独禁用。转至菜单项“安装 > 前置红外线/后置红外线”以禁用接收器。

6.6 使用触发器控制屏幕

该投影机配有两个带 3.5 mm 微型接口连接器的可编程触发器。它们可用于启用或禁用屏幕、幕布或其他外部设备。

要更改触发器设置，请转至菜单项“安装 > 触发器”

默认情况下：

- 触发器 1 被设置为根据投影机是否已通电来控制屏幕。
- 触发器 2 被设置为根据当前活动来源的纵横比来控制屏幕。

两个触发器的设置均可手动在菜单中改写，也可通过 RS-232 或 LAN 使用命令与控制协议来改写。

6.7 设置纵横比触发器行为

要自定义纵横比触发器功能，请转至菜单项“安装 > 触发器 > 纵横比触发器行为”。在此子菜单中，可选择触发器将支持哪些输入纵横比。

6.8 自动开机/关机

可使用内部定时器功能或 DPMS 来自动打开或关闭投影机。

6.8.1 使用定时器

投影机配有可进行时间控制的实时时钟。这表示投影机可设计为在特定的预设时间（每周循环）打开或关闭。

为了允许建立弹性时间表，本机提供了 10 个“程序”。对于每个程序，您可以为某天（周一到周日）、所有工作日（周一到周五）或周末（周六和周日）定义打开或关闭时间。根据需要，可同时激活一个、几个或所有程序。通过此方式可以建立弹性时间表。观察 24 小时时间格式。如需更多信息，请查看“设置 > 定时器”菜单。

以下示例说明了投影机在工作日（周一至周五）08:00（上午 8 点）打开并在 20:00（晚上 8 点）关闭的实例。在周末（周六和周日），投影机在 10:00（上午 10 点）打开并在 18:00（下午 6 点）关闭。VGA 用作来源。对于此实例，需要四个程序，其中两个程序用于打开，另外两个用于关闭。

6.8.2 使用 DPMS（显示能源管理信号）

该投影机支持 DPMS（显示能源管理信号）。启用后，如果输入没有显示有效信号源，则在指定的时间之后投影机将自动切换为待机模式。重新连接有效信号源后，将再次启动投影机。

要启用或禁用 DPMS，请转至菜单项“设置 > DPMS”。所需的 DPMS 超时在“DPMS > DPMS 超时”菜单项中设置。

DPMS 默认为禁用。

6.9 禁用 LED 指示灯

在某些配置中，可能需要完全禁用投影机键盘上的 LED 指示灯。要禁用 LED 指示灯，请转至菜单项“设置 > LED 指示灯静音”。

如果 LED 指示灯已启用，超时期间可在“设置 > 背景光超时”下面的菜单中设置。

6.10 设置背景颜色

投影机搜索来源时所显示的背景颜色可设置为一组预定义的颜色。转至菜单项“设置 > 背景”以设置所需的颜色。默认为黑色。设置 OSD 菜单超时

如果打开了 OSD 菜单却在一段时间内未使用，则它将自动关闭。默认时间是 30 秒。此超时时间可在 5 秒至 60 秒之间调节。OSD 菜单的超时也可设置为“从不”，即从不超时。转至菜单项“设置 > 菜单超时”以更改此设置。

6.11 选择启动徽标

当投影机启动时，整个显示屏上会显示一个徽标。如果希望禁用制造商的默认徽标，也可将徽标设置为“黑色”。转至菜单项“设置 > 启动”以更改此设置。

6.12 设置 OSD 菜单超时

如果打开了 OSD 菜单却在一段时间内未使用，则它将自动关闭。默认时间是 30 秒。此超时时间可在 5 秒至 60 秒之间调节。OSD 菜单的超时也可设置为“从不”，即从不超时。转至菜单项“设置 > 菜单超时”以更改此设置。

6.13 选择启动徽标

当投影机启动时，整个显示屏上会显示一个徽标。如果希望禁用制造商的默认徽标，也可将徽标设置为“黑色”。转至菜单项“设置 > 启动”以更改此设置。

7 优化图片

该投影机具备强大的图片优化功能。本章说明使用这些功能的详细信息。所有色彩校准均使用 projectiondesign 专有的真彩色 (RealColor™) 解决方案来完成。

7.1 校准数据

所有 projectiondesign 投影机在出厂时均已使用高精度设备进行测量和校准，可获得最佳的开箱即用体验。在灯泡的整个使用期限内，投影机的特性可能会发生细微的变化。更换灯泡时，也同样会有细微的变化。

7.1.1 更新 RealColor™ 校准数据

为了让 RealColor™ 系统产生精确的结果，需要使用精确的测量数据。

RealColor™ 校准数据可在菜单项“图片 > 校准 > 真彩色校准 > 测量值”下面找到

红色、绿色、蓝色、白色和 BrilliantColor™ 1 的 X、Y 和相对亮度值在此菜单中输入。对于 VizSim (RGBRGB) 色轮，BrilliantColor™ 应全部设置为 0.000。还可使用 RS-232 或局域网通信协议来更新所有值。

 在设置这些值之前，应该先选择 BrilliantColor™ 设置。转至菜单项“图片 > 真彩色 > 极致色彩”以选择想要的 BrilliantColor™ 外观。

测量必须使用内置测试图案来完成。由于可以使用电源来源正确生成 BrilliantColor™ 1 测试图案，因此对其而言这特别重要。这些图案可在“图片 > 校准 > 真彩色 > 校准测试图像”用户菜单中找到。使用箭头键循环浏览图像。

 恢复投影机的出厂设置即可将测量值还原为在工厂内测量的值。

 测量数据时，强烈建议使用高品质测量仪器以便获得精确的结果。光谱分析仪（如 PhotoResearch PR-655）是首选测量仪器。

 为了让校准步骤更简单，也可以使用 projectiondesign 的软件包 ProNet 来执行自动校准。ProNet 校准软件包的许可证必须单独购买。

7.2 使用 RealColor™

7.2.1 正确设置 BrilliantColor™

BrilliantColor™ 设置用于控制如何将色彩强化应用到图像中。它可设置为以下四种模式：

- 电脑本身（默认）：此设置实现最大亮度和色彩强化。推荐用于非视频应用，如 CAD 和可视化。
- 电脑平衡：产生与“电脑本身”相同的亮度，但是其色彩强化模式不那么强烈。
- 视频本身：比计算机的亮度更低，但是视频内容中的噪点也明显较少。
- 视频平衡：亮度与“视频本身”相同，但是色彩强化模式更平滑。
- 关闭：建议仅用于需要纯红色、绿色和蓝色混色的应用。混色中不添加任何次生色或白色。

7.2.2 伽玛

该投影机配备一组 6 个内置伽玛曲线：电影 2.2、电影 2.8、视频 1、视频 2、计算机 1 和计算机 2。不同伽玛曲线显示如下。



曲线的名称带有描述性，说明了其建议用途。对视频应用使用任一种计算机曲线将导致产生明显的图像噪点。



图 7-1. 电影 2.2 伽玛



图 7-2. 电影 2.8 伽玛

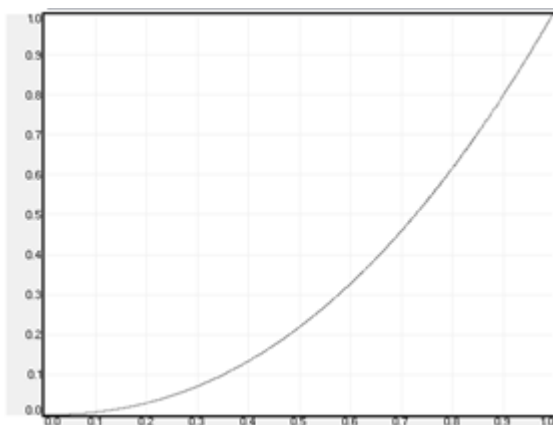

图 7-3. 视频 1 伽玛

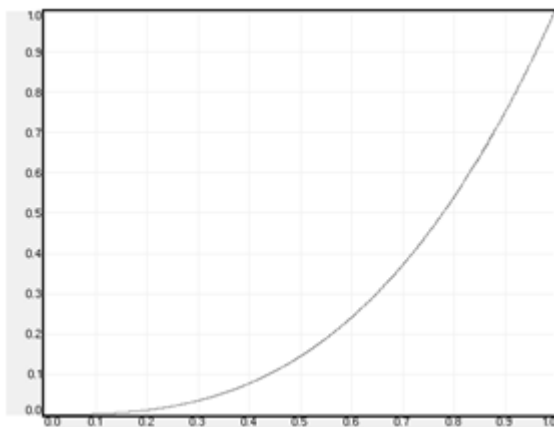

图 7-4. 视频 2 伽玛

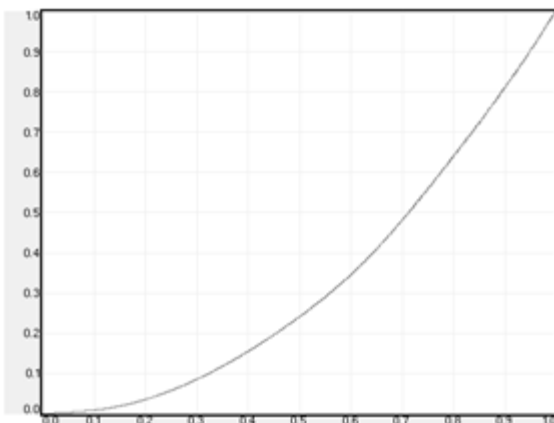

图 7-5. 计算机 1 伽玛

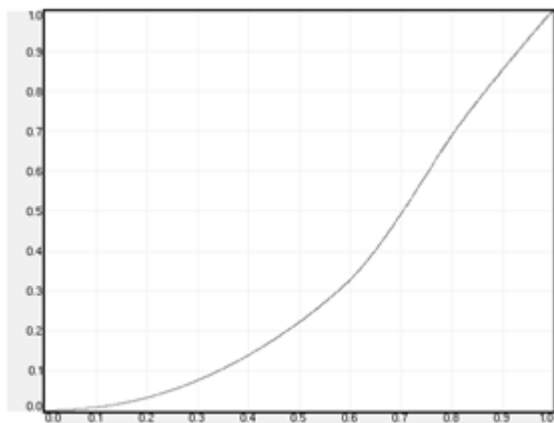

图 7-6. 计算机 2 伽玛

7.2.3 RealColor™ 操作模式

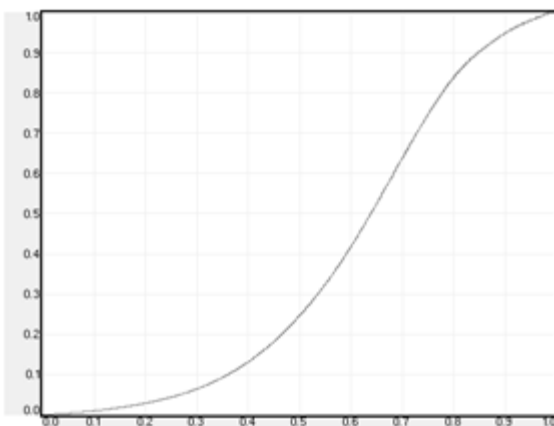
在将任何色彩校正应用到图像之前，必须先启用该功能。转至菜单项“图片 > 真彩色 > 色彩校正”以启用 RealColor™。

RealColor™ 可在 3 种模式下运行：

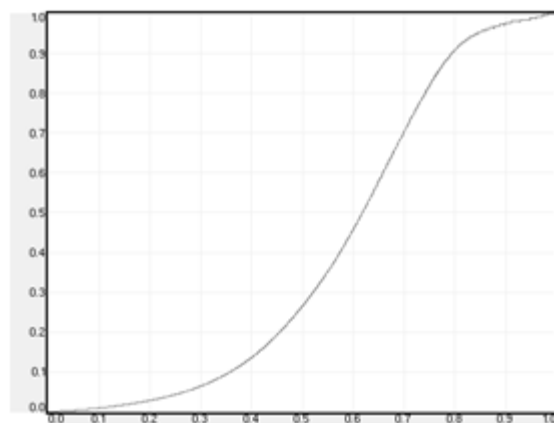
- 仅色温/白点校正。
- 红色、绿色、蓝色、白色校正。在此模式下，青色、洋红和黄色的最佳颜色坐标系将自动计算。
- 红色、绿色、蓝色、青色、洋红、黄色、白色。在此模式下，每种颜色的色点和强度可单独操控。

如需更改 RealColor™ 模式，请转至菜单项“图片 > 真彩色 > 所需值 > 所需坐标模式”。

7.2.4 设置白点或色温

启用 RealColor™ 之后，在“图片 > 真彩色 > 色温”菜单项中设置色温。可选择介于 3200K 和 9300K 之间的值。这些色温依附于“黑体曲线” - 即图 7-7 中 CIE 图表中心的黑色曲线。默认值为 D65 光源，色温为 6500K。



图 7-7. 带有黑体曲线的 CIE 图表

白点也可设置为自定义值，由未链接至黑体曲线的 x, y 坐标系定义。转至菜单项“图片 > 真彩色 > X 坐标”和“图片 > 真彩色 > Y 坐标”以更改白点。

7.2.5 定义系统色域

眼睛可看到的所有颜色均由图 7-7 中的 CIE 图表来定义。投影机可显示的色域被称为系统色域。图 7-7 中的白色三角形是系统色域的一个示例。默认情况下，投影机拥有尽可能宽广的系统色域，但它受系统所选色轮的限制。VizSim 色轮拥有最宽广的色域，而高亮度色轮拥有最窄的范围。

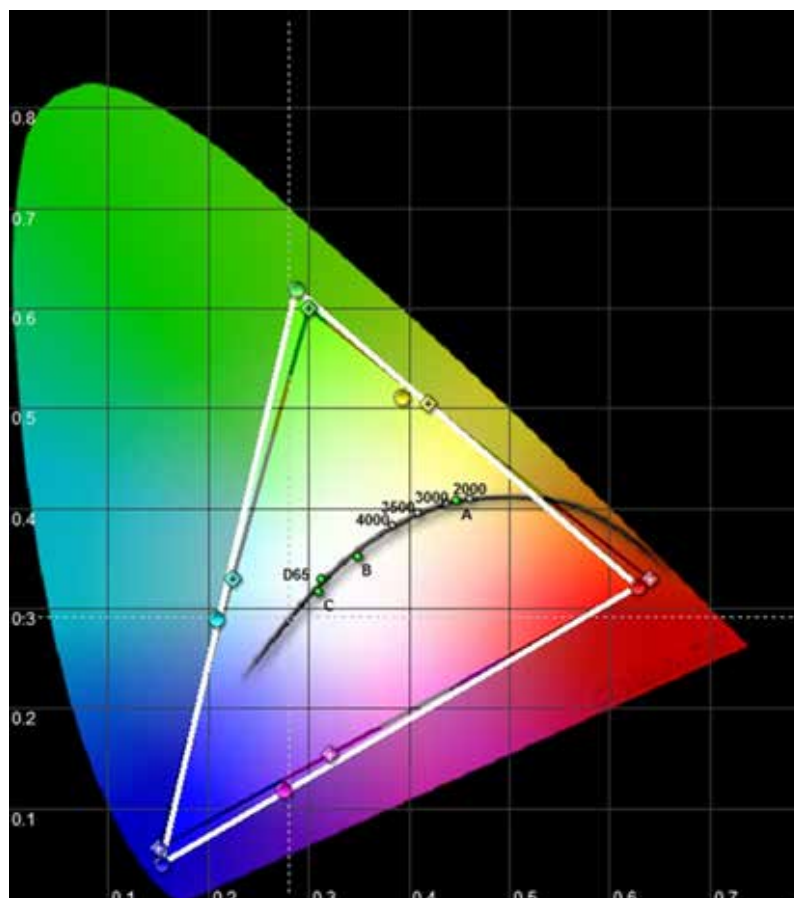

系统色域不能扩展到色轮所定义的色域之外。

投影机的系统色域可更改为：

- 颜色匹配多台投影机。
- 符合已定义的颜色标准，如 REC 709。
- 为图像生成特殊的“外观”。

必须先定义所需的 RealColor™ 模式，然后才可更改系统色域。如需更改 RealColor™ 模式，请转至菜单项“图片 > 真彩色 > 所需值 > 所需坐标模式”。

RealColor™ 必须启用，然后才能应用所需的系统色域。转至菜单项“图片 > 真彩色 > 色彩校正”以启用 RealColor™。

在启用 RealColor™ 及选择所需的色彩校正模式之后，请转至菜单项“图片 > 真彩色 > 所需值”以将色点更改为所需的系统色域。



如需以图形方式显示系统色域及轻松管理单台或多台投影机的颜色，可以使用 ProNet 软件包。ProNet 校准软件包的许可证必须单独购买。

8 维护

8.1 软件升级

如需升级投影机，请按照下述方法和顺序操作。

- 需要使用设置为 FAT 文件系统的 USB 记忆棒来执行此升级
- 从以下网址获取升级软件：
www.projectiondesign.com
- 下载 firmware.zip 文件并保存到您的 PC 桌面
- 将固件文件解压到记忆棒的根目录
PS!请记住，完成之后应使用 PC 上的弹出功能从计算机上安全移除 USB。
- 将投影机设置为待机模式
- 将记忆棒插入投影机并等待几秒钟
- LCD 显示屏上会出现提示，指明在记忆棒上检测到升级文件。等待几秒钟，让系统对文件进行验证
- 当 LCD 显示屏上指示您移除记忆棒时，请将其移除。
- 在升级进行过程中切勿拔下电源线
- 在升级过程中投影机可能会重启几次

回到平常的 LCD 显示状态时即表明升级成功完成。

请访问我们的网站下载所需的文件或查找其他信息

8.2 灯泡更换 (仅适用于超高压汞灯投影机)

当灯泡使用期限到期或灯泡出现故障时，键盘上的灯泡指示灯将变为红色。
 使用期限到期后更换灯泡。始终使用相同的类型和等级更换灯泡。只能使用原装灯泡。
 灯泡包括追踪灯泡使用期限的电子灯泡计时器。
 待灯泡冷却之后再更换。可在使用另一个灯泡的同时更换灯泡（热插拔）。
 旋开螺钉（灯泡 1）或（灯泡 2），具体取决于需要更换哪个灯泡。

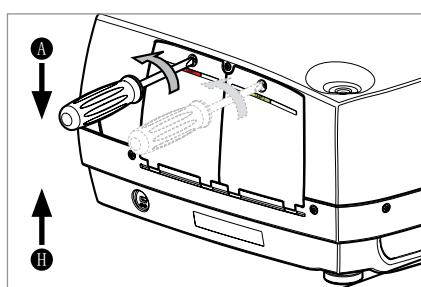

! 更换灯泡时当心不要碰触护镜，这可能导致护镜过热或在使用时破裂。

! 卸下灯管模块时要极其小心。万一灯泡破裂，可能会产生小玻璃碎片。灯管模块设计为包含这些碎片，但在卸下灯管模块时要小心。

A 打开灯泡盖。

B 逆时针直角回转三个螺钉。

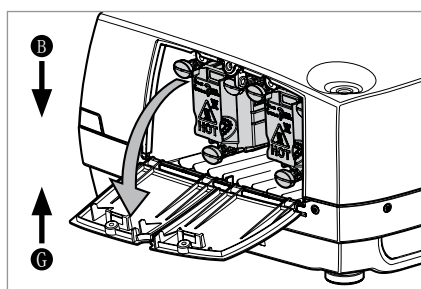

C 拔出灯泡。

D 按相反的顺序更换新灯泡。

E 插入新灯泡。观察定位销。

F 沿顺时针方向将三个锁紧螺钉转动 90 度。

G 关闭灯泡盖。

H 沿顺时针方向转动锁紧螺钉。

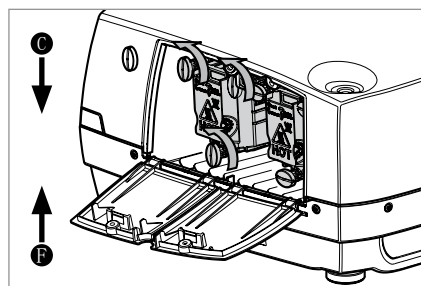

! 万一灯泡破裂，可能会有一部分汞蒸汽排放到房间内。为了避免吸入这些汞蒸汽（有毒，可能会对肺和神经系统造成伤害），应让房间保持彻底通风至少 30 分钟。暴露在封闭的完好灯罩内的灯泡之下不会产生已知的健康危害。偶尔接触损坏的灯管预期不会产生有害影响。根据经验，应避免持续或频繁地暴露在灯泡下，除非房间内有良好的通风。破裂的灯泡可能造成的重大危害是会产生小玻璃碎片。

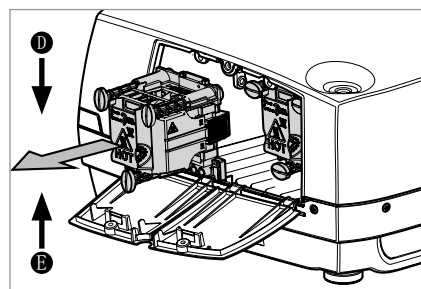

9 技术规范

9.1 产品细节

技术	单芯片 DMD™ (Digital Micromirror Device™)
概念	密封, 带有镜头位移的全玻璃光学设计
可用分辨率	WQXGA (2560 x 1600) PANORAMA (2560 x 1080)
连接	请参阅 4.3 Connectivity 小节中的一览表
尺寸 (dwh)	376 x 510 x 223 mm (例如, 镜头)
重量	约 12.6 kg (例如, 镜头)
环境	RoHS, WEEE
电源要求	8.4A ~100-240V 50-60Hz 功耗 <1050W (超高压) 功耗 <325W (LED)
BTU/hr	<2750 (超高压) / <1100 (LED)
使用温度	0 - 40°C / 32 - 104°F, 0 - 1500 m 0 - 35°C / 32 - 95°F, 1500 - 3000 m
一致性	CE, FCC A 类和 cCSAus
超高压汞灯	2 x 300W UHP™
灯泡寿命	全功率/节能模式可使用 2000/2500 小时 (在自动切换节能模式下可用 5000 小时*)
灯泡部件号	400-0500-00
LED 灯泡	LED 照明
灯泡寿命	长达 100000 小时 (全功率) 长达 100000 小时 (节能模式)
灯泡部件号	不适用

* 灯泡子菜单中的选项: 一次将点亮一个灯泡, 投影机将在指定的间隔时间 (1 小时至 24 小时) 自动在灯泡之间切换。



有关更广泛及最新的技术规格概述, 请参阅我们的主页 上的产品页。

PRODUCTION ADDRESS

Habornveien 53
1653 Gamle Fredrikstad
Norway

Model certification name:
GP3