

AMERICAN AUDIO®

PPA-210™

USER MANUAL







AMERICAN AUDIO®
6122 S. Eastern Ave
Los Angeles Ca. 90040
www.americanaudio.eu

TABLE OF CONTENT

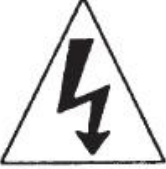
Electrical Safety Precautions	3
Important Safety Instructions	5
Main Features	10
Unpacking	11
Introduction	12
Customer Support	12
Set-Up Precautions	13
Operating Determinations	13
General Functions and Controls	14
Cable Storage.....	18
Open/Close the System	19
Connectors.....	20
Live Performance Set-Up	21
Mounting	22
Cleaning.....	23
Troubleshooting	24
ROHS – A Great Contribution to the Conservation of Environment	25
WEEE – Waste of Electrical and Electronic Equipment	26
Specifications.....	27

ELECTRICAL SAFETY PRECAUTIONS



	<p>WARNING</p> <p>TO PREVENT FIRE OR SHOCK HAZARD, DO NOT EXPOSE THIS DEVICE TO RAIN, LIQUID OR MOISTURE!</p>	
	<p>CAUTION</p> <p>TO PREVENT ELECTRIC SHOCK DO NOT USE THIS (POLARIZED) PLUG WITH AN EXTENSION CORD, RECEPTACLE OR OTHER ELECTRICAL OUTLET UNLESS THE WIDE BLADES CAN BE CAREFULLY INSERTED INTO A MATCHING WIDE SLOT!</p>	



The lightning flash with an arrow triangular symbol is intended to alert the user to the presence of non-insulated “dangerous voltage” within the product’s enclosure, and may be of sufficient magnitude to constitute a risk of electric shock.



The exclamation point triangular symbol is intended to alert the user to the presence of important operating and maintenance (servicing) instructions in the user manual accompanying the unit.

	<p>CAUTION</p> <p>RISK OF ELECTRIC SHOCK! DO NOT OPEN!</p> <p>TO REDUCE THE RISK OF ELECTRIC SHOCK, DO NOT REMOVE THE COVER (OR BACK). THERE ARE NO USER SERVICEABLE PARTS INSIDE. REFER SERVICE TO YOUR AUTHORIZED AMERICAN AUDIO® SERVICE TECHNICIAN.</p>	
---	--	---

This product satisfies FCC regulations when shielded cables and connectors are used to connect the unit to other equipment. To prevent electromagnetic interference with electrical appliances such as radios and televisions, use shielded cables and connectors for connections.

The serial and model number for this unit is located on the rear panel.

Please write down the numbers here and retain for future reference:

Model No. _____

Serial No. _____

Date of Purchase _____

Dealer Name _____

Dealer Address _____

Dealer Phone _____

IMPORTANT SAFETY INSTRUCTIONS

Read Instructions – All the safety and operating instructions should be read before the product is operated.

Retain Instructions – The safety and operating instructions should be retained for future reference.

Heed Warnings – All warnings on the product and in the operating instructions should be adhered to.

Follow Instructions – All operating and use instructions should be followed.

Cleaning – The product should be cleaned only with a polishing cloth or a soft dry cloth. Never clean with furniture wax, benzene, insecticides or other volatile liquids since they may corrode the cabinet.

Attachments – Do not use attachments not recommended by the product manufacturer as they may cause hazards.

Water and Moisture – Do not use this product near water — for example, near a bathtub, wash bowl, kitchen sink, or laundry tub; in a wet basement; or near a swimming pool; and the like.

Accessories – Do not place this product on an unstable cart, stand, tripod, bracket, or table. The product may fall, causing serious injury to a child or adult and serious damage to the product. Use only with a cart, stand, tripod, bracket, or table recommended by the manufacturer, or sold with the product. Any mounting of the product should follow the manufacturer's instructions, and should use a mounting accessory recommended by the manufacturer.

Cart – A product and cart combination should be moved with care. Quick stops, excessive force, and uneven surfaces may cause the product and cart combination to overturn.



Ventilation – Slots and openings in the cabinet are provided for ventilation and to ensure reliable operation of the product and to protect it from overheating, and these openings must not be blocked or covered. The openings should never be blocked by placing the product on a bed, sofa, rug, or other similar surface. This product should not be placed in a built-in installation such as a bookcase or rack unless proper ventilation is provided or the manufacturer's instructions have been adhered to.

Power Sources – This product should be operated only from the type of power source indicated on the marking label. If you are not sure of the type of power supply to your home, consult your product dealer or local power company.

Location – The appliance should be installed in a stable location.

Nonuse Periods – The power cord of the appliance should be unplugged from the outlet when left un- used for a long period of time.

Grounding or Polarization

- If this product is equipped with a polarized alternating current line plug (a plug having one blade wider than the other), it will fit into the outlet only one way. This is a safety feature. If you are unable to insert the plug fully into the outlet, try reversing the plug. If the plug should still fail to fit, contact your electrician to replace your obsolete outlet. Do not defeat the safety purpose of the polarized plug.
- If this product is equipped with a three-wire grounding type plug, a plug having a third (grounding) pin, it will only fit into a grounding type power outlet. This is a safety feature. If you are unable to insert the plug into the outlet, contact your electrician to replace your obsolete outlet. Do not defeat the safety purpose of the grounding type plug.

Outdoor Antenna Grounding – If an outside antenna or cable system is connected to the product, be sure the antenna or cable system is grounded so as to provide some protection against voltage surges and built-up static charges.

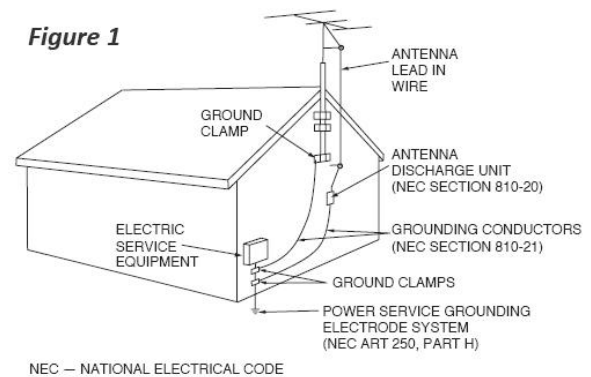

Article 810 of the National Electrical Code, ANSI/NFPA 70, provides information with regard to proper grounding of the mast and supporting structure, grounding of the lead-in wire to an antenna discharge unit, size of grounding conductors, location of antenna-discharge unit, connection to grounding electrodes, and requirements for the grounding electrode.

See **Figure 1**.

Power Cord Protection – Power-supply cords should be routed so that they are not likely to be walked on or pinched by items placed upon or against them, paying particular attention to cords at plugs, convenience receptacles, and the point where they exit from the product.

Lightning – For added protection for this product during a lightning storm, or when it is left unattended and unused for long periods of time, unplug it from the wall outlet and disconnect the antenna or cable system. This will prevent damage to the product due to lightning and power-line surges.

Power Lines – An outside antenna system should not be located in the vicinity of overhead power lines or other electric light or power circuits, or where it can fall into such power lines or circuits. When installing an outside antenna system, extreme care should be taken to keep from touching such power lines or circuits as contact with them might be fatal.

Overloading – Do not overload wall outlets, extension cords, or integral convenience receptacles as this can result in a risk of fire or electric shock.

Object and Liquid Entry – Never push objects of any kind into this product through openings as they may touch dangerous voltage points or short-out parts that could result in a fire or electric shock. Never spill liquid of any kind on the product.

Servicing – Do not attempt to service this product yourself as opening or removing covers may expose you to dangerous voltage or other hazards. Refer all servicing to qualified service personnel.

Damage Requiring Service – Unplug this product from the wall outlet and refer servicing to qualified service personnel under the following conditions:

- When the power supply cord or plug is damaged.
- If liquid has been spilled, or objects have fallen into the product.
- If the product has been exposed to rain or water.
- If the product does not operate normally by following the operating instructions. Adjust only those controls that are covered by the operating instructions as an improper adjustment of other controls may result in damage and will often require extensive work by a qualified technician to restore the product to its normal operation.
- If the product has been dropped or damaged in any way.
- When the product exhibits a distinct change in performance - this indicates a need for service.

Replacement Parts – When replacement parts are required, be sure the service technician has used replacement parts specified by the manufacturer or have the same characteristics as the original part. Unauthorized substitutions may result in fire, electric shock, or other hazards.

Safety Check – Upon completion of any service or repairs to this product, ask the service technician to perform safety checks to determine that the product is in proper operating condition.

Wall or Ceiling Mounting – The product should not be mounted to a wall or ceiling.

Heat – The product should be situated away from heat sources such as radiators, heat registers, stoves, or other products (including amplifiers) that produce heat.

For adult use only - Keep out of the reach of children.

Water and Moisture - This equipment should not be used near water - for example, near a bath tub, kitchen sink, laundry tub, in a wet basement or near a swimming pool, etc. Do not spill water or other liquids into or onto your equipment.

Ventilation - The device should be situated so that its location or position does not interfere with its proper ventilation. For example, the device should not be situated on a bed, sofa, rug, or similar surface that may block the ventilation openings; or, placed in a built-in installation, such as a bookcase or cabinet that may impede the flow of air through the ventilation openings.

Heat - The device should be situated away from heat sources such as radiators, heat registers, stoves, or other appliances (including amplifiers) that produce heat.

Power Sources - The device should be connected to a power supply (wall outlet) only of the type described in the operating instructions or as marked on the Device.

Servicing -The user should not attempt to service the device beyond that described in the operating instructions. There are no user serviceable parts inside. All other servicing should be referred to qualified service personnel. The device should be serviced by qualified service personnel when:

- The power-supply cord or the plug has been damaged.
- Objects have fallen onto, or liquid has been spilled into the device.
- The device has been exposed to rain or water.
- The device does not appear to operate normally or exhibits a marked change in performance.

Cleaning - The device should be cleaned only as recommended by the manufacturer. Use a soft cloth to wipe down the outside of the unit. For stubborn stains moisten a soft cloth with glass cleaner or other mild detergent to wipe away any stains. Use a soft cloth to wipe any residual cleaner. Never use volatile cleaners such as benzine, solvent, or thinner to clean your unit, these cleaners will damage the units' surface.

Power Cord Protection - Power supply cords should be routed so that they are not likely to be walked on or pinched by items placed upon or against them, paying particular attention to cords at plugs, convenience receptacles, and the point where they exit from the device. Route your power cord out of the way of foot traffic.

Caution

- Never disassemble or modify your unit in any way, doing so will void your manufacturer's warranty.
- Never plug this device into a dimmer pack.
- Do not let insecticides, benzene, or thinner come in contact with the surface of the unit.
- This unit is intended for indoor use only; use of this product outdoors voids all warranties.
- Always mount this unit in a safe and stable manner.
- Disconnect from main power before making any type of connection.
- Handle the power supply cord carefully. Do not damage or deform; it may cause electric shock or malfunction when used. Hold plug attachment when removing from wall outlet. Do not pull on the cord.
- To avoid electric shock, do not open the top cover when the unit is plugged in. If problems occur with the unit, call American Audio® customer support.
- Do not place metal objects or spill any liquids inside or on the device. Electric shock or malfunction may occur.
- Always have the trim controls set to their lowest level during initial power-up to prevent speaker damage.

MAIN FEATURES

- 4 Mono & 2 Stereo Channel Inputs
- Stereo Main Outputs
- Trim With Peak LED, 3-Band EQ, Aux/EFX, & Pan For Mono Input
- Main L/R, Aux Return, Tape Level
- 24-Bit DSP Effect, 100 Presets, EFX On/Off & EFX Level
- Tape With PFL Switch, HP/Control Room & Phantom Power
- 4 Mono Ch. Inputs, Mic Input (XLR), 1/4" Line Inputs (TRS)
- For Stereo Input (Ch 7-Ch 8) RCA Line Inputs or Mini Jack TRS Inputs
- 1/4" Phone Jack For Main, Aux Send, EFX Send, Control Room & Headphone
- Jack For Tape & 1/4" Phone Jack For Footswitch

UNPACKING

This unit has been thoroughly tested and has been shipped in perfect operating condition. Carefully check the shipping carton for damage that may have occurred during shipping.

If the carton appears to be damaged, carefully inspect your unit for any damage. Be sure all accessories needed to operate the unit have arrived intact.

In the event damage has been found or parts are missing, please contact our toll free customer support number for further instructions.

Please do not return the unit to your dealer without first contacting customer support.

INTRODUCTION

Congratulations and thank you for purchasing the American Audio® PPA-210™ portable sound system.

The PPA-210™ is a representation of American Audio®'s continuing commitment to produce the best and highest quality audio products possible at an affordable price.

Please read and understand this manual completely before attempting to operate your new device. These instructions contain important safety information regarding the use and maintenance of this unit. Take special care to follow all warning symbols and labels both on the unit and printed in this manual.

Also, please keep this manual with the unit for future reference.

CUSTOMER SUPPORT

American Audio® provides a toll free customer support line, to provide set up help and answer any questions, should you encounter problems during your initial set up or operation.

You may also visit us on the web at www.americanaudio.us for any comments or suggestions.

Service Hours are Monday through Friday 9:00 a.m. to 5:30 p.m. Pacific Standard Time.

Voice: (800) 322-6337

Fax: (323) 582-2941

E-mail: support@americandj.com

To purchase parts online visit <http://parts.americandj.com>

Caution

There are no user serviceable parts inside this device. Do not attempt any repairs yourself, without being instructed to do so by an authorized American Audio® service technician. Doing so will void your manufactures warranty. In the unlikely event your device may require service, please contact American Audio® customer support.

Do not discard the packing carton in the trash. Please recycle whenever possible.

SET-UP PRECAUTIONS

Please be sure to make any connections before plugging the player into an electrical outlet. All fader and volume controls should be set to zero or minimum position before the player is switched on. If the player has been exposed to drastic temperature fluctuation (e.g. after transportation), do not switch on the player immediately. The arising condensation of water might damage your device. Leave the device switched off until it has reached room temperature.

OPERATING DETERMINATIONS

- When installing this player, please make sure that the device is not exposed or will not be exposed to extreme heat, moisture or dust!
- Do not operate the player in extremely hot (more than 30°C/100°F) or extremely cold (less than 5°C/40°F) surroundings.
- Keep the unit out of direct sunlight and away from heaters.
- Operate the player only after becoming familiar with its functions.
- Do not permit operation by persons not qualified for operating the unit. Most damages are the result of unprofessional operation.

GENERAL FUNCTIONS AND CONTROLS

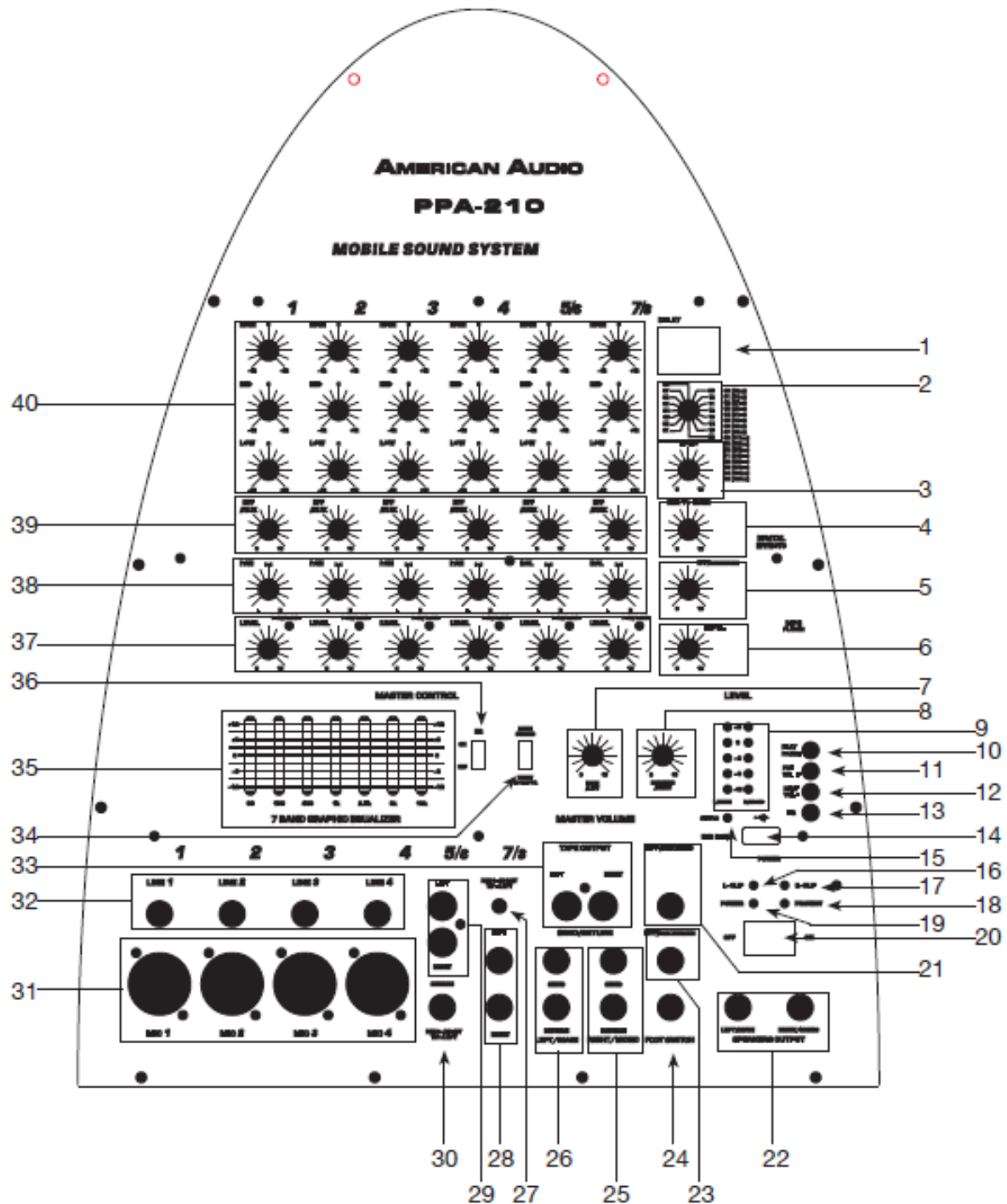

(1) Digital Delay Display – 00 (12ms) to 15 (197ms)

(2) Digital Delay Display Adjustment – Adjust the digital effects delay time.

(3) Digital Echo Adjustment – Adjust the amount of Echo effect that is sent through either the *EFFX/AUX* output or *Mix to Main* output.

(4) Mix to Main – Adjust the output level of the Digital Delay Effects for all channels evenly.

(5) EFF/AUX knob – Adjust the level of the onboard effects or the level of the input of an outboard effect machine that is patched thru the PPA-210™.

(6) MP3 Level – MP3 input level adjustment.

(7 & 8) Master Volume Control – These left and right master control knobs are used to control the master output level (main volume). To avoid distorted output try to maintain an average output signal level no greater than +4 dB. To avoid speaker damage that may be caused by excessive volume, be sure these knobs are always set to zero (completely down) before turning the unit on.

(9) Master Volume Level Indicators – The dual *Master Level LED Indicators* are used to detail the master fader output level. The meters will detail the output level of both the Left/Main and Right/Mono channels.

(10) MP3 Play/Pause button – Press this button to either play or pause the built-in MP3 player.

(11) Previous Track / Volume Decrease button – Press this button to go back to the previous track, or hold to decrease the volume.

(12) Next Track / Volume Increase Button – Press this button to go to the next track, or hold to increase the volume.

(13) MP3 EQ – Mode set up for the MP3 player. Toggle thru *OFF-JAZZ- ROCK-POP-CLASSIC-COUNTRY*.

(14) USB Port – Play your MP3 files on a flash memory device. One folder maximum.

(15) USB LED Indicator – This LED indicates the working status of the USB port. When the LED is lit it means the unit is in standby mode, when the LED is blinking it means the unit is reading data.

(16) L-CLIP LED – This LED indicator will “light” when the input signal reaches 5dB below the channel’s clipping point. If the LED “lights” more than usual, you should decrease the input level of the channel. If this does not work, reduce the output level of the connected source.

(17) R-CLIP LED – This LED indicator will “light” when the input signal reaches 5dB below the channel’s clipping point. If the LED “lights” more than usual, you should decrease the input level of the channel. If this does not work, reduce the output level of the connected source.

(18) Protect LED – This LED glows when output is shorted or the load impedance is too low.

(19) Power LED – This LED glows when the power is turned *ON*.

(20) Power Switch – Turns the system power on/off.

(21) EFF/AUX Send Jack – Use this 1/4" jack to accept an external effects processor. Use the EFF/AUX knob to control the output level.

(22) Speaker Outputs – These are the powered speaker outputs designed for each of the PPA-210™ speakers. Use the included cables to connect the speakers to the outputs.

(23) EFF/AUX Return Jack – Use this 1/4" jack to connect the output signal from an external effect processor. This input stereo jack is designed to accept signals from an external effects machine. This input can also be used as a stereo input with the output volume controlled by the *Master Volume* knobs.

(24) Foot Switch Jack – You can connect a foot switch to this jack, and use the foot jack to toggle the digital effects on/off.

(25) Right Channel Send/Return Jack – This jack is used to patch in an equalizer or other processor into the PPA-210™. The other end of the jack should be connected to the output of the external device.

(26) Left Channel Send/Return Jack – This jack is used to patch in an equalizer or other processor into the PPA-210™. The other end of the jack should be connected to the output of the external device.

(27) Stereo Input – Use this 1/8" mini jack to connect a tape player, CD player, DVD player or any other stereo source. You can also use this jack to connect the output of a computer sound card or other similar devices.

(28) Stereo Inputs – Use these 1/4" jacks to connect a tape player, CD player, DVD player or any other stereo source. You can also use this jack to connect the output of a computer sound card or other similar devices.

(29) Stereo Inputs – Use these RCA jacks to connect a tape player, CD player, DVD player or any other stereo source. You can also use this jack to connect the output of a computer sound card or other similar devices.

(30) Stereo Inputs – Use these 1/4" jacks to connect a tape player, CD player, DVD player or any other stereo source. You can also use this jack to connect the output of a computer sound card or other similar devices.

(31) MIC Input Jacks – These are balanced 3-pin XLR-type input jacks.

(32) Line Input Jacks – These standard 1/4" TRS phone jacks are used for balanced or unbalanced line level signals. Some examples of line level equipment include most electronic keyboards, synthesizers, and line outputs from other devices.

(33) Stereo Out Jacks – The stereo out RCA jacks provide a mix output that is independent of the *Master Level* controls. A recording device, such as a cassette or DAT recorder can be connected to record your show. Changes made to input level controls, channel EQ, and echo

controls will be heard in the tape out mix. Changes made to the *Master Level* controls will not affect the level of the recording.

(34) Stereo/Dual Select or Switch – In *Stereo* mode, the system operates as a traditional stereo power device/amplifier. In *Dual* mode, the channel level controls set the level for the *Main Mix* (left master volume control). The *Rev/Aux* controls set the level for the *Monitor* (right master volume control). When the *Dual* mode position is selected, the *Pan* and *Balance* controls will not work.

(35) System Equalizer – Adjusts the amount of frequency in the channel. The left and right channels are adjusted simultaneously. When the equalizer is set the middle position, the frequency response is “flat”. Sliding the equalizer up increases the frequency, sliding it down decreases it. When setting the EQ start from the middle (0dB).

(36) EQ (Equalizer) Control On/Off – Lets you turn the system EQ on or off.

(37) Level Control knobs – Adjust the volume level of the individual channel. Adjust this level after the *Master Output Volume* level has been set.

(38) PAN Control knobs – This control “pans” the channel signal across the master L and R buses, therefore determining the ideal position of the sound from that channel.

EXAMPLE: If the PAN control is set all the way to the left, the sound from that channel will only be projected from the left speaker only. Same goes for the control being set all the way to the right, only from the right speaker.

(39) EFF/AUX Output Control knobs – Adjusts the amount of signal sent to the effects processor and to the EFF/AUX output jack.

(40) Channel Controls

- **Channel High Control** – This knob is used to adjust the high (treble) frequency levels of the channel. Turning the knob in a counter-clockwise direction will decrease the amount of treble applied to a channel signal, turning the knob in a clockwise direction will increase the amount of treble applied to a channel signal.
- **Channel Mid Control** – This knob is used to adjust the midrange levels of the channel. Turning the knob in a counter-clockwise direction will decrease the amount of midrange applied to a channel signal, turning the knob in a clockwise direction will increase the amount of midrange applied to a channel signal.
- **Channel Low Control** – This knob is used to adjust the low frequency levels of the channel. Turning the knob in a counter-clockwise direction will decrease the amount of bass applied to a channel signal, turning the knob in a clockwise direction will increase the amount of bass applied to a channel signal.

CABLE STORAGE

Located at the rear of the mixing console is a storage area.

You can store the speaker cables and other cables in this storage area.

OPEN/CLOSE THE SYSTEM

To open and close your PPA-210™ system, follow the instructions below.

1. To separate the speakers from the console, locate the latches at the top and press the latches in. While pressing the latches in, gently pull the speakers away from the mixing console.
2. To reattach the speakers to the device, line up pegs on the bottom of the speaker with the holes on the mixing console. Place the knobs into these holes and press the latch buttons while connecting the speaker. Release the latch button when the speaker is connected. Check to make sure the connection is secure before picking up the system and transporting.

Caution: *Be very careful that you do not pinch your fingers when closing your PPA-210™ system!*

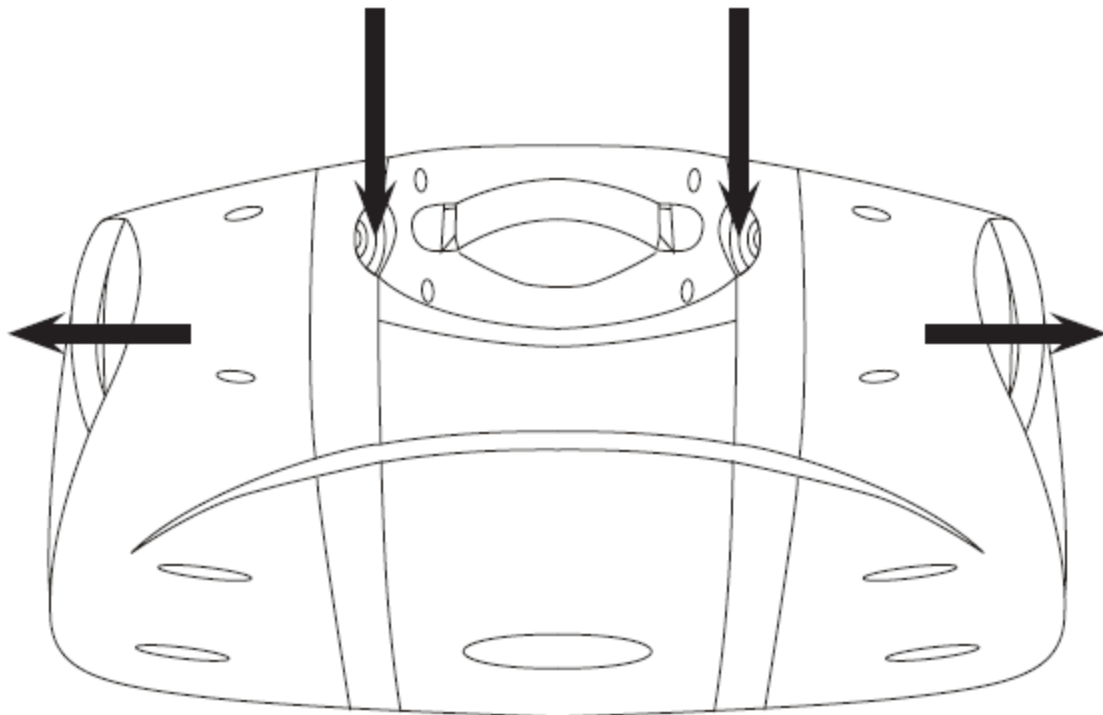

CONNECTORS

Connector and cable configurations are recommended for use with the M 4 bus series.

These cables are based on the use of auxiliary equipment that is isolated from the AC power mains.

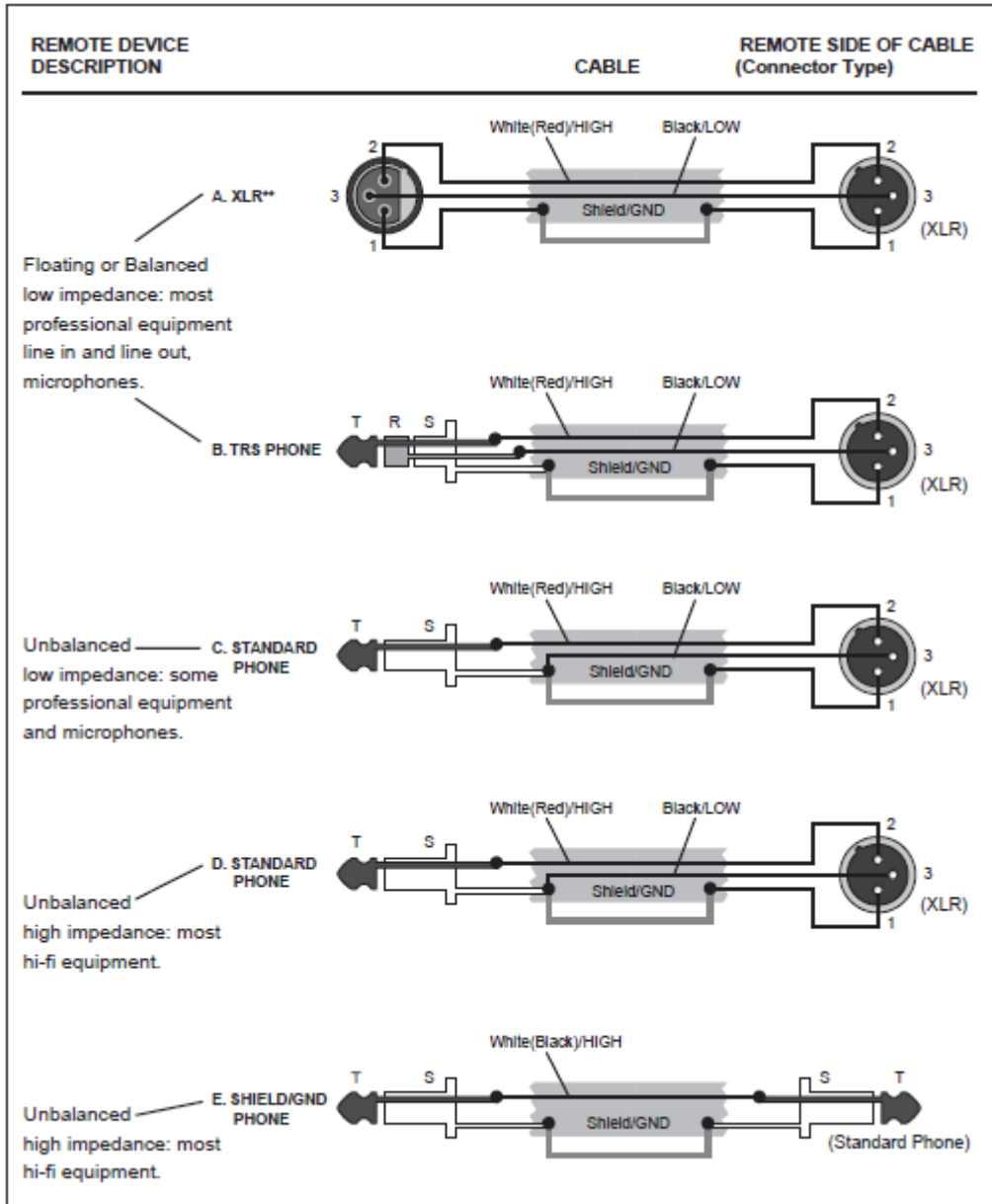

LIVE PERFORMANCE SET-UP

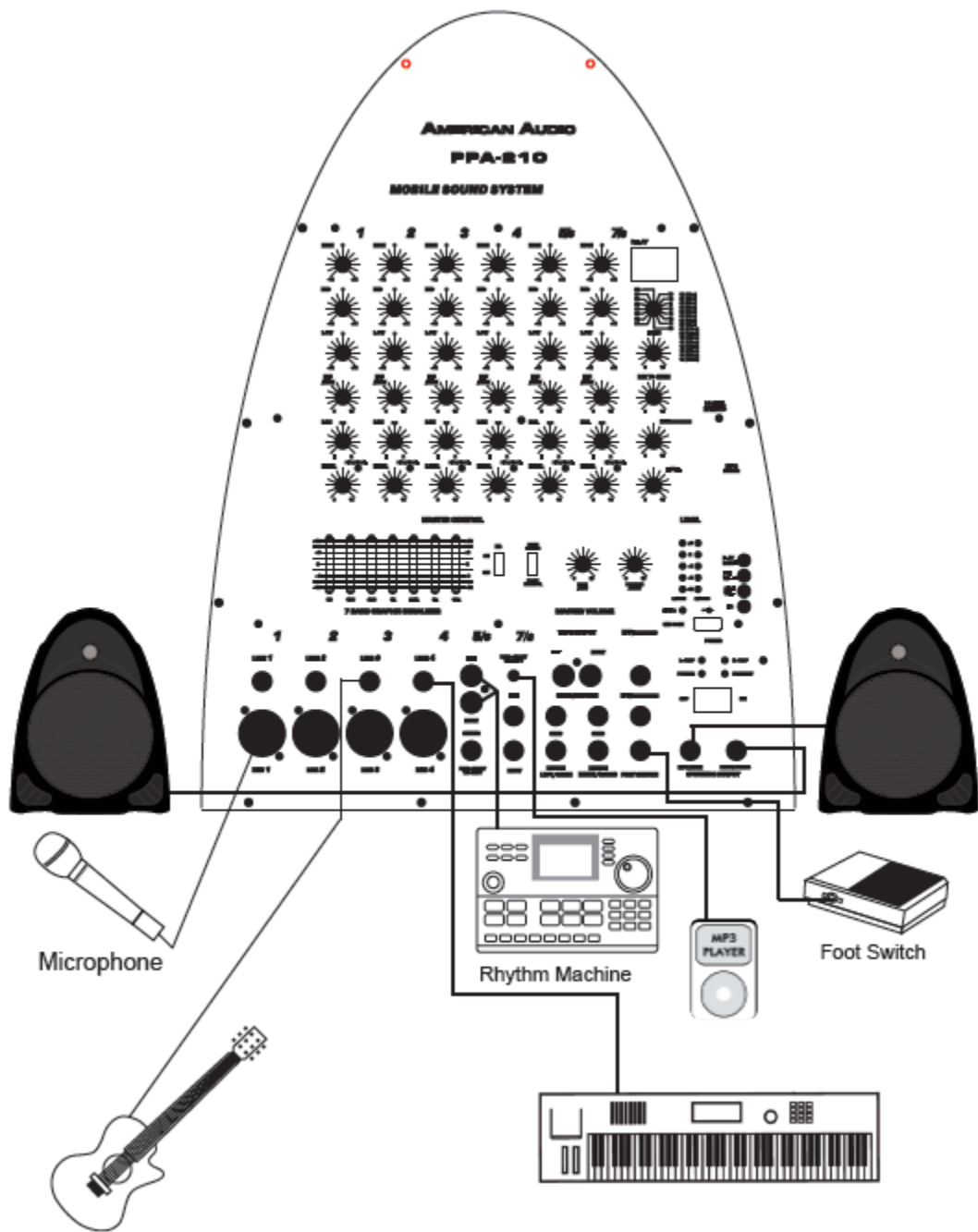

MOUNTING

The PPA-210™ also includes a pole mount option. The pole mount socket located on the bottom of the speaker may be used to secure the speaker to a speaker tri-pod, such as the American Audio® SPS-1B or the SPS-2B.

Always be sure to follow the guidelines listed below when pole mounting your speaker:

- Always be sure the stand is designed to support the weight of the speaker
- In outdoor situations that are prone to windy conditions and strong wind gust, be sure to use sandbags as additional tri-pod support, this will greatly reduce the risk of tipping
- Do not stack speakers on top of each other when mounting on a tri-pod. Only one speaker should be mounted to a tri-pod at one time.
- Always position the tri-pod legs away from foot traffic
- Extend the tri-pod legs to their fully extended position to avoid accidental tipping
- Observe and follow all safety guidelines and regulations specified by the tri-pod's manufacturer
- Be sure the tri-pod is situated on a flat, level, and stable surface
- Always tighten all tri-pod locks



CLEANING

Dust will settle in the fader track – over time, dust can cause a popping noise on the fader. To prevent this, cover you device. If the device has been unused for over a month or more move you faders up and down a couple of times this will move most of the settle dust from the fader track. Do not eat, drink, or smoke over or near the device.

Do not use spray cleaners. Use compressed air or a vacuum with a brush accessory.

Cleaning frequency depends on the environment in which the device operates (i.e. smoke, fog residue, dust, dew).

TROUBLESHOOTING

Listed below are common problems you may encounter, and solutions.

I can't hear the source from a channel thru the main mix!

- *Check the Trim knob, fader, and output volume on your source.*
- *Check the Mute button, or make sure your sub groups are assigned to the mains.*
- *Check your connection from the source to the device.*
- *Try the same connection on a different channel with the same settings.*

I hear noise in mix!

- *Check your power. A 60 Hz hum could come from ungrounded equipment.*
- *Turn all the faders down one at a time and the stereo return knob. If the noise goes away, it's that channel or the source. Disconnect the source from the device, bring up that fader: if the noise is gone it's your source. If it's the source, try bringing down its output volume.*

I have no power!

- *Make sure your power supply is properly hooked up to the unit.*

I can't hear the mix on my headphones or my control room monitors!

- *Check the phones / control room knob and select the proper source.*

ROHS – A GREAT CONTRIBUTION TO THE CONSERVATION OF ENVIRONMENT

The European Union has adopted a directive on the restriction / prohibition of the use of hazardous substances. This directive, referred to as ROHS, is a frequently discussed topic in the electronic industry.

It restricts, among other things, six materials: Lead (Pb), Mercury (Hg), hexavalent chromium (CR VI), cadmium (Cd), polybrominated biphenyls as flame retardant (PBB), polybrominated diphenyl, also a flame retardant (PBDE). The directive applies to nearly all electronic and electrical devices whose mode of operation involves electric or electromagnetic fields – in short: each kind of electronics we have around us in our households or at work.

As manufacturers of products of the brands of AMERICAN AUDIO®, AMERICAN DJ, ELATION Professional and ACCLAIM Lighting, we are obligated to comply with the RoHS directive. Therefore, as early as two years prior to the directive coming into force, we started our search for alternative environmentally friendly materials and manufacturing processes.

Well before the RoHS directive took effect, all of our products were manufactured meeting the standards of the European Union. With regular audits and material tests we can still assure that the components we use are always RoHS-compliant and that the manufacturing process, as far as the state of technology allows, is environmentally friendly.

The ROHS directive is an important step to the protection of our environment. We, as manufacturers, feel obligated to make our contribution in this respect.

WEEE – WASTE OF ELECTRICAL AND ELECTRONIC EQUIPMENT

Every year thousands of tons of electronic components, which are harmful to the environment, end up at the waste disposals around the world. To ensure the best possible disposal or recovery of electronic components, the European Union has adopted the WEEE directive.

The WEEE-system (Waste of Electrical and Electronic Equipment) can be compared with the system of the “Green Spot”, which has been in use for several years. The manufactures have to make their contribution to the utilization of waste at the time they release the product. Money resources obtained by doing so will be applied to develop a common system of waste management. Thereby we can ensure professional and environmentally friendly scraping and recycling program.

As manufactures, we are part of the German system of EAR and we make our contribution towards it.

(Registration in Germany: DE41027552)

That means that products of AMERICAN DJ and AMERICAN AUDIO® can be left in the collection points free of charge and they will be used in the recycling program. Products of ELATION Professional, which are used only by professionals, shall be handled by us. Please send Elation products directly to us at the end of their lifetime so that we can professionally dispose of them.

Like the above ROHS, the WEEE directive is an important contribution to the environment protection and we are glad to help to clean the environment with this disposal system.

We are happy to answer any of your inquiries and welcome your suggestions at:
info@americandj.eu

SPECIFICATIONS

Model:	PPA-210™
Power supply:	AC 115v~60Hz/230v~50Hz
Single Voltage:	AC 100V, 50/60Hz (Japan) AC 110V, 60Hz (Colombia) AC 120V, 60Hz (U.S.A. and Canada) AC 127V, 60Hz (Mexico) AC 220V, 50Hz (Chile and Argentina) AC 240V, 50Hz (Australia) AC 220V, 60Hz (Philippines and Korea) AC 230V, 50Hz (Europe, U.K., New Zealand, South Africa & Singapore)
Fuse:	7A
Total Dimension:	778mm (L) x 348mm (W) x 478mm (H) 30.6" (L) x 13.7" (W) x 19" (H)
Speakers:	280mm (L) x 348mm (W) x 478mm (H) 11" (L) x 13.7" (W) x 19" (H)
Power Tower:	274mm (L) x 348mm (W) x 518mm (H) 10.7" (L) x 13.7" (W) x 20.3" (H)
Weight:	6.17 Lbs. / 2.8 Kgs.
Operating Temp.:	5°C to 35°C
Humidity:	25 to 85% RH (non-condensing)
Storage Temp.:	-20 to 60 °C
Freq. Response:	20Hz to 20kHz 1dB (At Send Output) 30Hz to 20kHz 1dB (At Speaker Output, w/ Processor Threshold Exceeded)
Distortion:	<0.05%, 20Hz to 20kHz, 1dB below rated output
Signal to Noise Ratio:	>80dB@ 1W. "A" WTD

Power Output: 150 W/Channel Continuous Average Power, 8 ohm, Both Channels
Driven W/ THD <1%

Input Impedance: (Channels 1-4) "Mic" 2 kOhm
Line 33 kOhm
(Stereo Channels 5/6, 7/8) 33 kOhm

Max. Input Level Mic: -7 dBu

Line Input Level: 30 dBu

Stereo Input Level: 26 dBu

Return Input Imp.: 47 kOhm

EQ Specifications: CH 1-8 3 BAND EQ RANGE:
HIGH: 10 kHz +/-12 dB
MID: 2.5 kHz +/-12 dB
LOW: 100 Hz +/-12 dB

7 BAND GRAPHIC EQ:
63 Hz +/-12 dB(+/-2 dB)
160 Hz +/-12 dB(+/-2 dB)
400 Hz +/-12 dB(+/-2 dB)
1 kHz +/-12 dB(+/-2 dB)
2.5 kHz +/-12 dB(+/-2 dB)
6.3 kHz +/-12 dB(+/-2 dB)
16 kHz +/-12 dB(+/-2 dB)

**©American Audio® World Headquarters:
6122 S. Eastern Ave. Los Angeles, CA 90040 USA
Tel: 323-582-3322 Fax: 323-582-2941
Web: www.americanaudio.us E-mail: info@americandj.com**

**American DJ Europe
Junostraat 2
6468 EW Kerkrade
Netherlands
service@americandj.eu / www.americandj.eu
Tel: +31 45 546 85 00 / Fax: +31 45 546 85 99**