

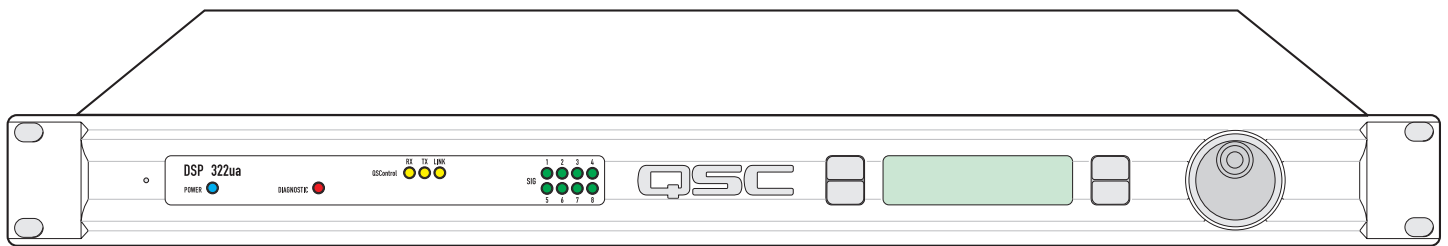

DSP 322ua

8x8 Signal Processor Hardware Manual



IMPORTANT SAFETY PRECAUTIONS & EXPLANATION OF SYMBOLS



The lightning flash with arrowhead symbol within an equilateral triangle is intended to alert the user to the presence of uninsulated "dangerous" voltage within the product's enclosure that may be of sufficient magnitude to constitute a risk of electric shock to humans.



The exclamation point within an equilateral triangle is intended to alert the user to the presence of important operating and maintenance (servicing) instructions in this manual.

SAFEGAURDS



Electrical energy can perform many useful functions. This unit has been engineered and manufactured to assure your personal safety. Improper use can result in potential electrical shock or fire hazards. In order not to defeat the safeguards, observe the following instructions for its installation, use and servicing.



CAUTION: To reduce the risk of electric shock, do not remove the cover. No user-serviceable parts inside. Refer servicing to qualified service personnel.



WARNING: To prevent fire or electric shock, do not expose this equipment to rain or moisture.

- 1- Maximum operating ambient temperature is 50°C (122°F).
- 2- Never restrict airflow through the device fan or vents. Please insure that the air intake and exhaust vents are unobstructed.
- 3- When installing equipment into rack, distribute the units evenly. Otherwise, hazardous conditions could be created by an uneven weight distribution.
- 4- Connect the unit only to a properly rated supply circuit. The DSP 322ua is suitable for connection to 100 - 240 VAC, 47 - 440 hertz, with no special considerations other than the appropriate IEC power cord.
- 5- Reliable Earthing (Grounding) of rack-mounted equipment should be maintained.



LITHIUM BATTERY WARNING

THIS EQUIPMENT CONTAINS A NON-RECHARGEABLE LITHIUM BATTERY. LITHIUM IS A CHEMICAL KNOWN TO THE STATE OF CALIFORNIA TO CAUSE CANCER OR BIRTH DEFECTS. THE NON-RECHARGEABLE LITHIUM BATTERY CONTAINED IN THIS EQUIPMENT MAY EXPLODE IF IT IS EXPOSED TO FIRE OR EXTREME HEAT. DO NOT SHORT CIRCUIT THE BATTERY. DO NOT ATTEMPT TO RECHARGE THE NON-RECHARGEABLE LITHIUM BATTERY.

FCC INTERFERENCE STATEMENT

NOTE: This equipment has been tested and found to comply with the limits for a class B digital device, pursuant to part 15 of the FCC rules. These limits are designed to provide reasonable protection against harmful interference in a residential installation. This equipment generates, uses, and can radiate radio frequency energy and if not installed and used in accordance to the instructions, may cause harmful interference to radio communications. However, there is no guarantee that interference will not occur in a particular installation. If this equipment does cause harmful interference to radio or television reception, which can be determined by switching the equipment off and on, the user is encouraged to try to correct the interference by one or more of the following measures:

- Reorient or relocate the receiving antenna.
- Increase the separation between the equipment and the receiver.
- Connect the equipment into an outlet on a circuit different from that to which the receiver is connected.
- Consult the dealer or an experienced radio or TV technician for help.



Don't want to read the entire manual? Just want to dig right in? Go to page 14....

Introduction

The DSP 322ua provides signal processing needs for an integrated functioning system. In conjunction with QSCControl.net software, the DSP 322ua enables the user to design, test and deploy professional audio reinforcement systems ranging in size from one to hundreds of channels.

A standard Windows computer is the principle user-interface for controlling the overall DSP/QSCControl.net system. However, the DSP 322ua also offers a front panel interface for accessing critical functions.

A single QSCControl.net server computer can support several clients running QSC's latest Venue Manager software. Thus, the sound system can be operated via several computers, roaming wireless laptops, tablets, etc., all at the same time, from anywhere a connection to the QSCControl.net network is available.

The QSCControl.net network can also be managed from a single computer running both the client and the server. Once all

QSCControl devices in a system are configured, a computer is no longer required on that system's network. All basic functions of the DSP 322ua continue to operate with or without a control computer connected to the network.

The configurable DSP engine provides all of the functions necessary to handle the amp/loudspeaker portion of a signal chain, such as very flexible and precise crossovers, delays, equalization, compression/limiting, etc.

Audio enters a DSP 322ua through the 8 universal analog inputs. The inputs accept everything from mic to line level and are equipped with software-selectable +48V phantom power.

Unlike many configurable DSP boxes, the intrinsic processing latency of the DSP 322ua is both short and fixed at 0.396 milliseconds. With analog inputs and analog outputs, the total delay is 2.354 milliseconds. The delay does not change

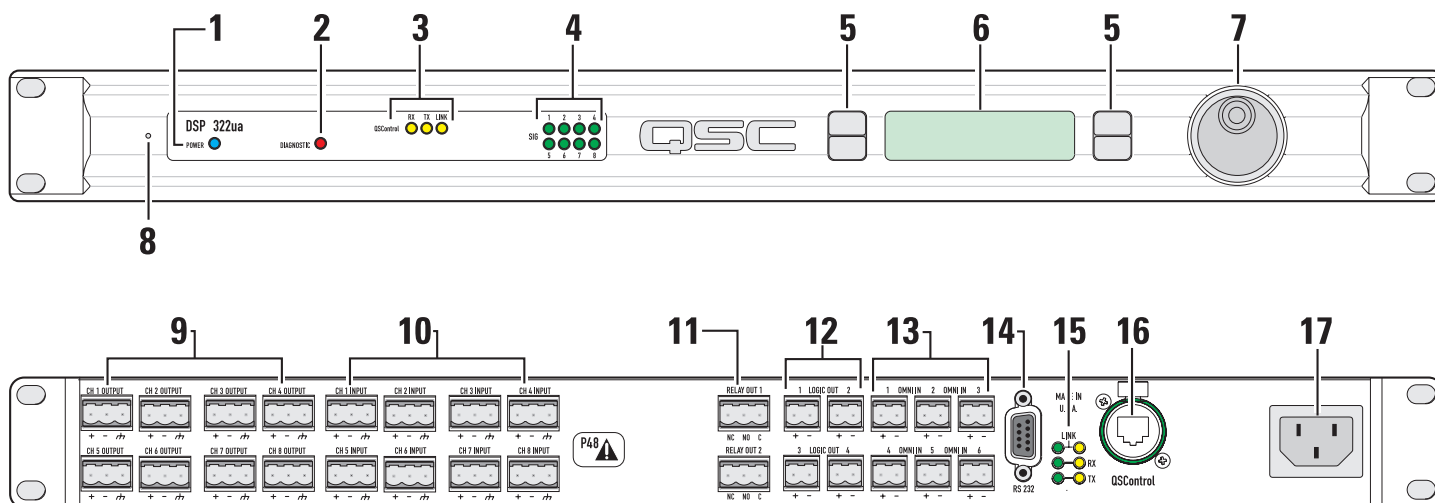

- | | |
|--------------------------------|-----------------------------------|
| 1- Power indicator | 10- mic/line inputs |
| 2- Diagnostic indicator | 11- Relay outputs |
| 3- Network status indicators | 12- Logic outputs |
| 4- Signal presence indicators | 13- Omni inputs |
| 5- Multi-function push buttons | 14- RS-232 port |
| 6- Display | 15- Network status indicators |
| 7- Rotary select/accept knob | 16- QSCControl 10BaseT receptacle |
| 8- Safe Mode switch (recessed) | 17- IEC power inlet |
| 9- Analog outputs | |



See page 10 for detailed descriptions.

Introduction (continued)

regardless of the DSP configuration, unless the configuration intentionally adds more delay.

Both software and firmware can be easily updated over the network. In the future, QSC will be adding new capabilities to QSCControl.net. Our latest code releases and access to up-to-date information on QSCControl.net are available at www.qscontrol.net. We invite you to visit us there.

We are confident that your new DSP 322ua will provide years of dependable service and we hope it will help you, the system designer and implementer, to express your creative audio system ideas.

Block Diagram

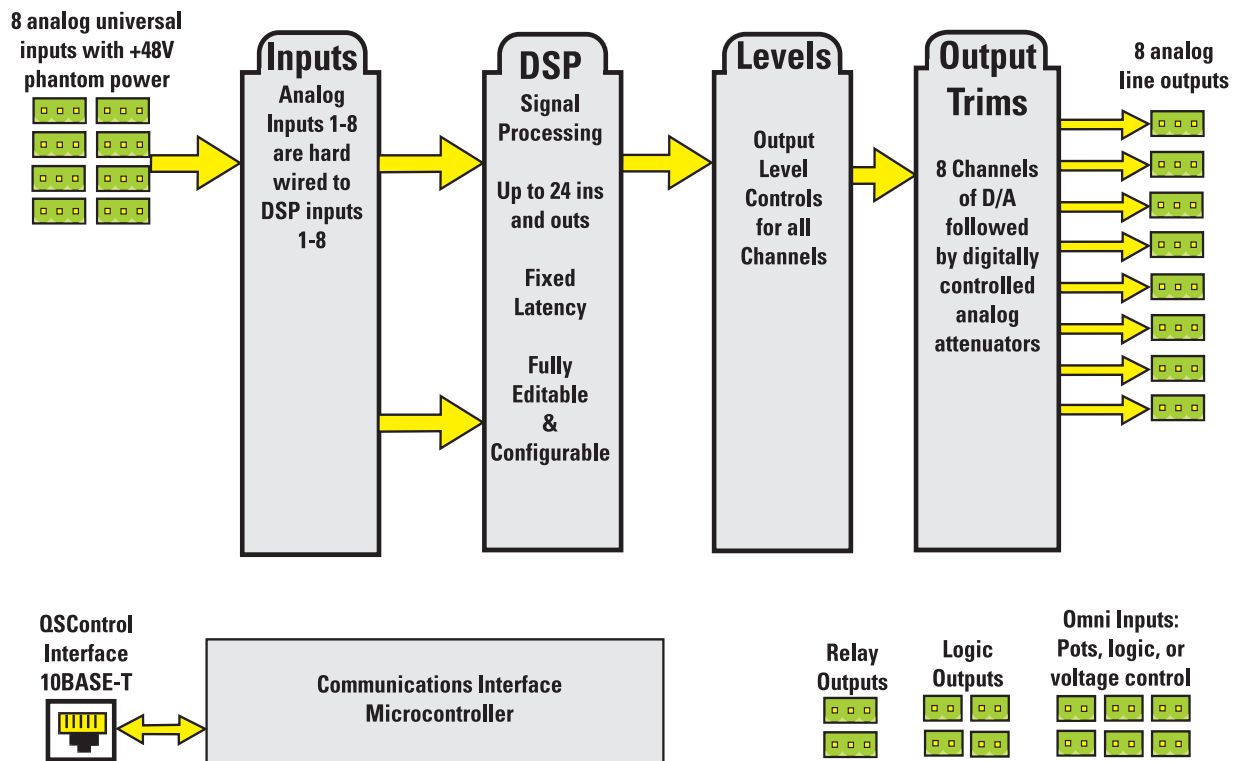

Introduction - Networking the DSP 322ua

Notes on Network System Design:

As with any communications system, the reliability and performance of a local area network (LAN) is intimately related to the designer's skill and knowledge in implementing a topology that is robust, efficient and standards-compliant. Proper network design is even more critical in distributed multimedia systems. Therefore, it is important for the system designer to realize that some conventional network practices could have an impact on the ability of the audio control system to provide real-time performance. Although each network design is unique and may carry its own performance requirements, the following points will assist in building an audio network that is trouble free and efficient.

First, we recommend designing a network that is to be used exclusively for "QSCControl.net" communications. Rest assured, your DSP 322ua has been designed to communicate over standard 10Base-T Ethernet using standard network protocols and standard network hardware. As such, DSP 322ua products are tolerant of conventional data communications services and products such as those that offer file sharing, e-mail services, and Internet access. However, these conventional data services can consume network resources and ultimately degrade the performance of your DSP 322ua product. Therefore, we strongly encourage designers to limit traffic on their audio control network to QSCControl.net related communications.

Second, your DSP 322ua should not be installed on the same LAN or "virtual" LAN (VLAN) with distributed audio and/or video services. While coexistence with conventional data communications services is tolerated to some extent, sharing a network with distributed audio and/or video is not. Distributed media services can monopolize a network by sourcing high-bandwidth broadcast content to all end stations. As a result, the performance of unintended recipients suffers. An experienced designer can apply techniques such as data filtering to block media content, but the typical installation requires compliance to this second point in order to ensure reliable performance from your QSCControl.net network.

Third, we recommend designing networks with "switch" technology rather than deploying Ethernet repeaters. Doing so will provide a network that is scalable and efficient and one that will offer real-time performance from your DSP 322ua products in the presence of multiple control computers.

To learn more about network design rules and system compliance visit the QSC network resources page at <http://www.qscaudio.com/products/network/resources.htm>.

The following examples will help get you started, but they just scratch the surface of what can be achieved with advanced networking...

Example #1 - QSCControl.net X-over mode:

This is the simplest connection you can make between the DSP 322ua and your computer. Use a CAT-5 crossover cable connected between the DSP QSCControl port and your computer's Network Interface Card, (NIC). No network switch is required. With QSCControl.net server and client software installed and running on your computer you will be able to completely set up your DSP 322ua.

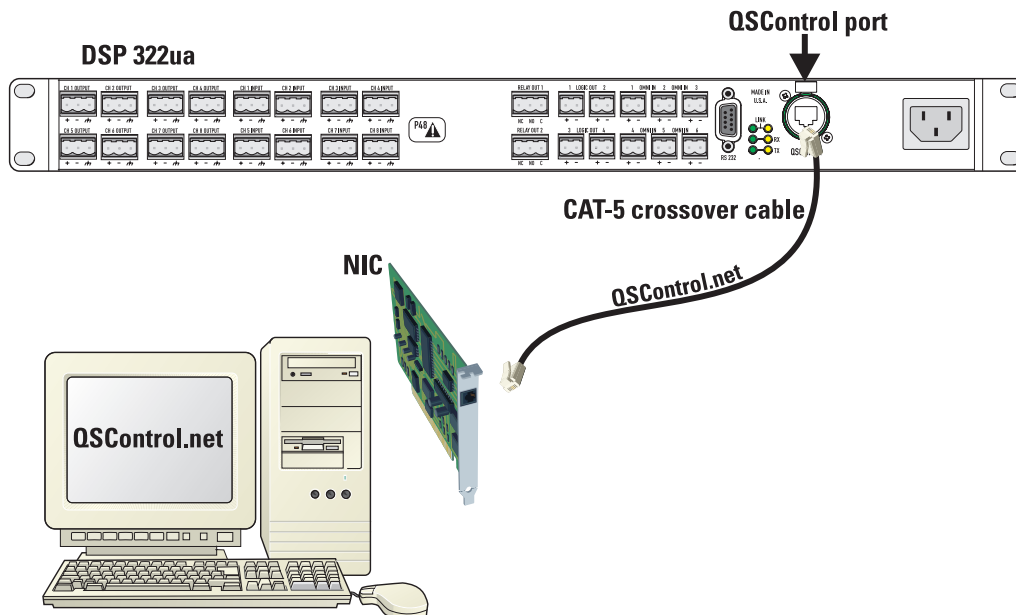

Example #2 - Connection to an Unmanaged Switch:

Switches can be connected to other switches to build larger networks; all of the normal networking principles apply. Here all QSControl.net traffic resides on a single unmanaged Ethernet switch. The DSP 322ua connects directly to the switch. A computer hosting a QSControl.net server application also connects directly to the switch. All configuration and monitoring of the DSP 322ua is performed via the PC.

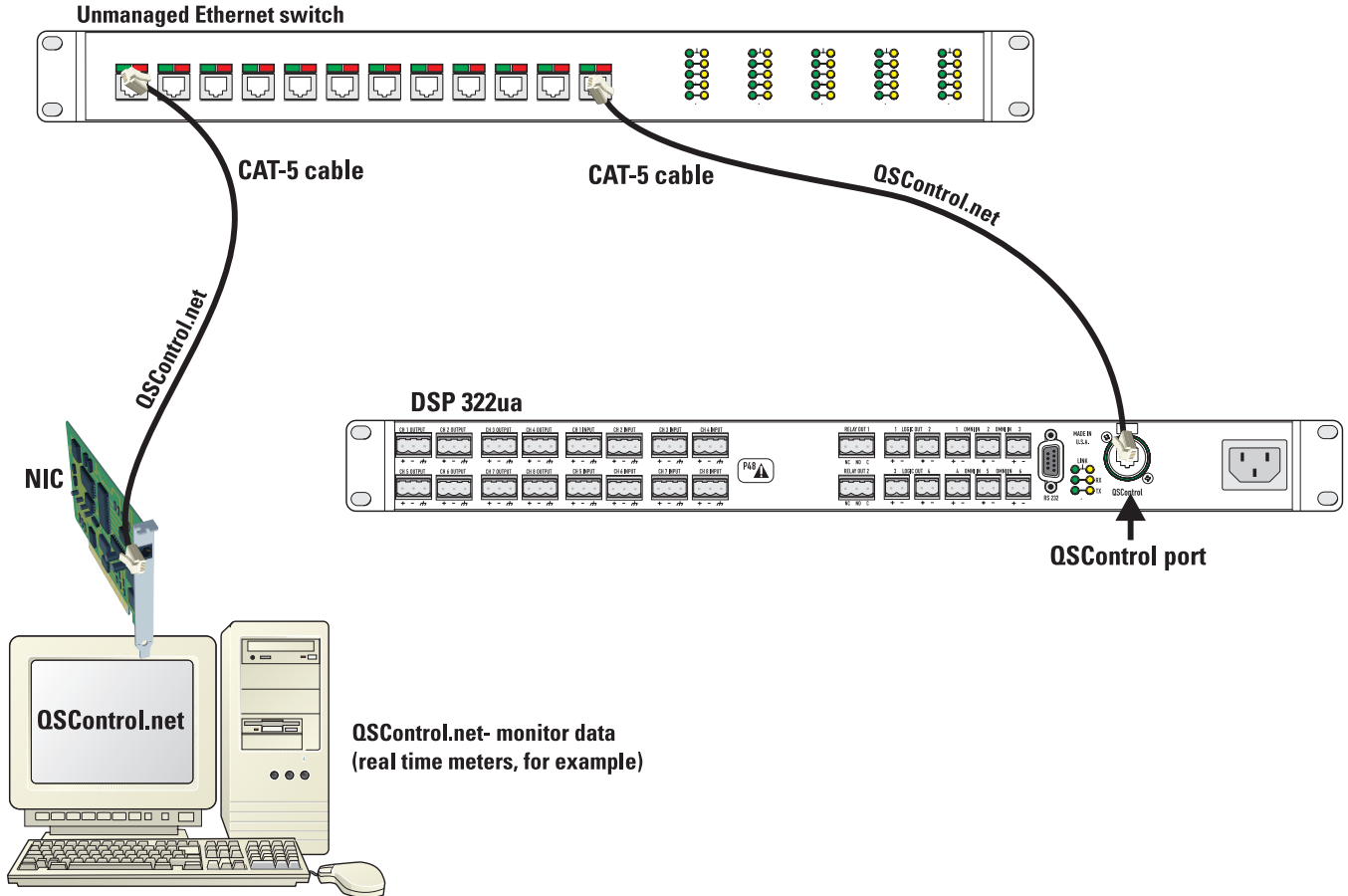

Example #3 - Connection to a Managed Switch:

This example illustrates a connection with a managed Ethernet switch. The switch is configured with multiple virtual local area networks (VLANs). Ethernet deliveries can only reach destination ports belonging to the same VLAN from which it was sourced. The figure shows a separate VLAN for QSControl.net traffic and a separate VLAN for CobraNet audio traffic. This configuration essentially provides a dedicated network for QSControl.net (including the system controller) and a second dedicated network for CobraNet audio. As with the previous example, as many units may be connected as there are switch ports available. Switches can be connected to other switches to build larger networks; all of the normal networking principles apply.

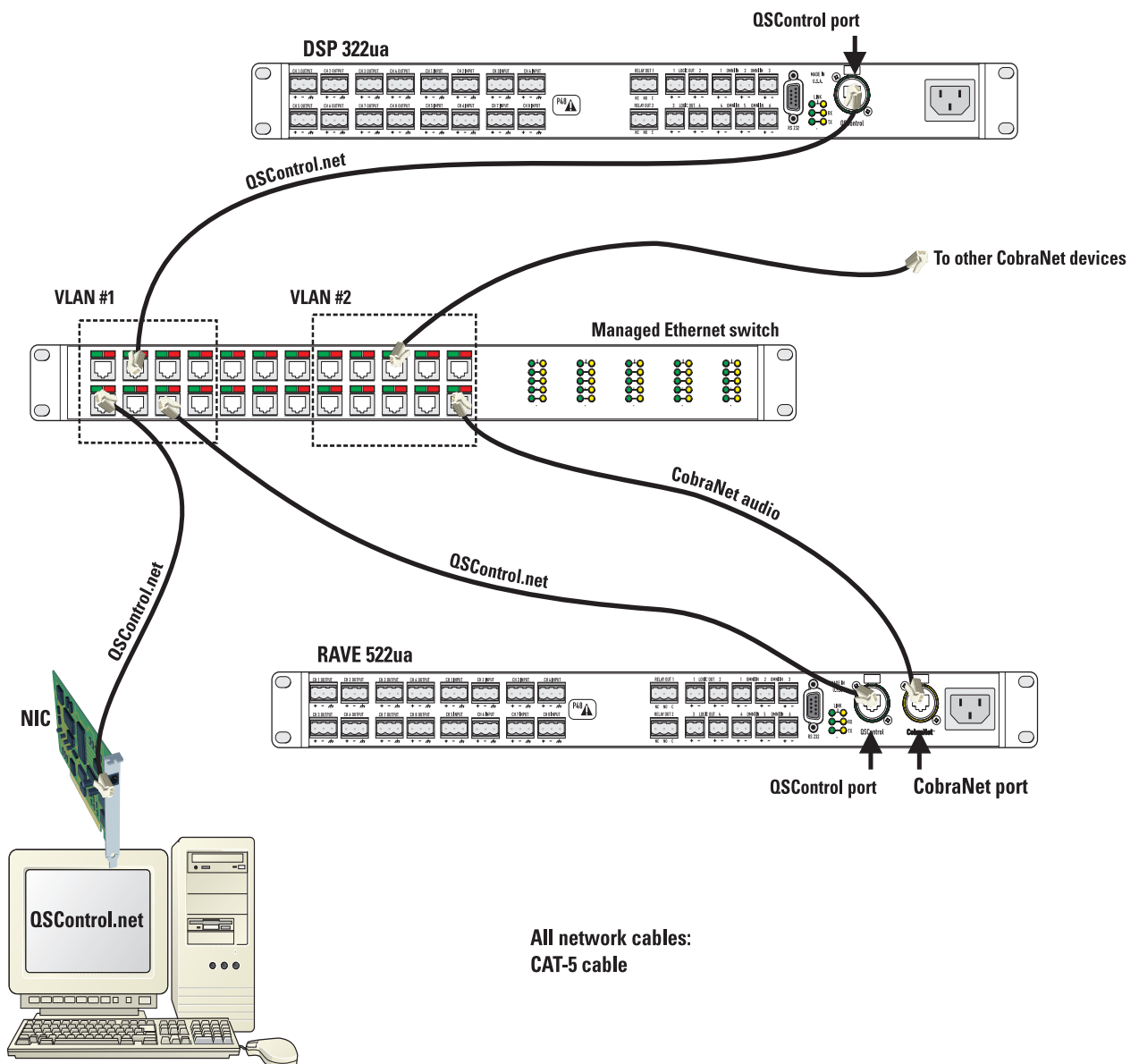

Unpacking

There are no special unpacking precautions. However, it is recommended you keep the original packing material for reuse in the rare event that service be required. If service is required and the original packing material is not available, ensure that the unit is adequately protected for shipment (strong box of appropriate size, sufficient packing material to prevent load-shifting or impact damage) or call QSC's Technical Services Department for packing material and a carton.

What is included in the carton:

Item	Description	Quantity
1	DSP 322ua	1
2	Self-adhesive rubber feet	4
3	Hardware Manual (this document)	1
4	QSCControl.net Software CD	1
5	IEC Power Cord 3 x #18 AWG	1
6	3-pin terminal block connector	18
7	2-pin terminal block connector	10

Mounting

The DSP 322ua can be used in or out of an equipment rack. Rack mounting is optional. Adhesive rubber feet are included for non-rack mount installations. Use them to prevent the unit from scratching or marring support surfaces.

Rack Mounting

Rack mount the DSP 322ua by supporting it from underneath while aligning the mounting holes with the threaded screw holes in the rails; install all four mounting screws and washers and tighten securely. Ensure use of all four mounting screws in order to minimize the chance of bending or distorting the rack mount ears. If the DSP 322ua is to be transported while in a rack, we recommend supporting the rear of the chassis. This will help prevent the unit from being damaged from the increased mechanical stresses of portable and mobile use. The DSP 322ua's chassis includes integral rear mounting tabs for securing to the rack mounting ears.

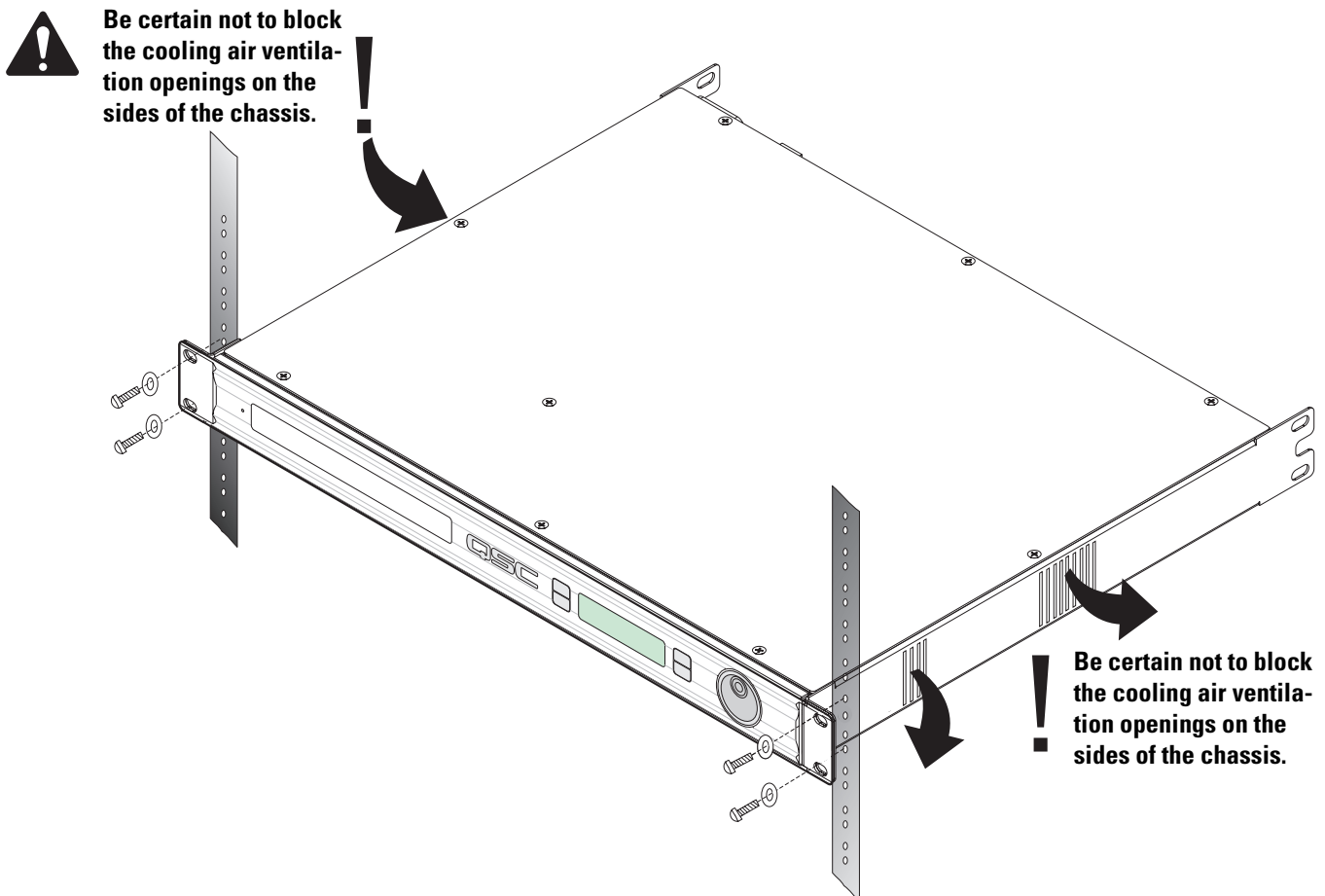

Computer Requirements & Software Installation

Installing QSControl.net is easy. All you need to do is choose the folder where the program is to be stored (the default setting is acceptable for most applications). We recommend your system meet the following minimum requirements:

- 1- IBM PC compatible computer with a Pentium 4 processor.
- 2- Processor speed of 1 GHz (2 GHz or faster recommended for systems with 30 or more BASIS/RAVE/DSP units).
- 3- 512 megabytes of RAM (1 gigabyte recommended for systems with 30 or more BASIS/RAVE/DSP units).
- 4- Hard drive with at least 500 MB of free space for the program and files you generate.
- 5- Display resolution of 1024 X 768, 16-bit color.
- 6- CD-ROM drive to install the software.
- 7- 10BaseT/100BaseTx network interface card (the DSP322ua uses only 10Mbit (10BaseT) connection)
- 8- Windows XP Professional, XP Home, Windows 2000 SP2 (or better), or Windows NT4.0 SP6a operating system. Windows 95, 98 and ME platforms are not supported.

Note: If system is used for real-time adjustments and configuration of audio systems, we recommend all Windows Power Options (located in the Windows Control Panel) features be disabled. Display, hard drive, system standby and hibernation settings should be set to "Never". This avoids waiting for the system to "wake-up" if adjustment is needed after an elapsed period of time.

To Install QSControl.net:

- 1- Start your computer and start Windows.
- 2- If there are any programs running, please close them now. Be sure to leave Windows running.
- 3- Place the QSControl.net CD-ROM in your CD-ROM drive. If your system supports the Auto Run feature installation begins automatically, otherwise, you can click **Start** on the task bar, click **Run**, and browse for the file named setup.exe from the CD.
- 4- Click the **Install QSControl.net** button.
- 5- Follow the installation instructions on the screen.

To Uninstall QSControl.net:

- 1- Click the **Start** menu button and choose **Settings/Control Panel**.
- 2- Double-click the **Add/Remove Program** icon.
- 3- Select QSControl.net from the list, then click **Add/Remove**.
- 4- Click Yes to confirm you would like to uninstall QSControl.net.

General Information & Configuration Memories

Network

The network should be operable and QSControl.net software should be installed/running on the system controller computer.

Configuration Memories

The DSP 322ua has non-volatile storage locations that contain settings for the device as well as DSP signal flow. The storage locations make it possible to set up the DSP for different situations and quickly recall the setup with or without QSControl.net software using the front panel controls.

Connections

AC Power Cord

Insert the molded receptacle of the AC power cord into the AC power inlet on the back of the DSP 322ua. Plug the AC line connector into the AC outlet. The power supply will accept from 100 to 240 Volts AC, 47 to 440 Hertz, without any changes. If a different type of IEC power cord is required than the one supplied with your 322ua, contact QSC's Technical Services Department.

QSCControl

Connect one end of a category-5 cable terminated with an RJ45 plug into the **QSCControl** receptacle. Insert the RJ45 plug into the receptacle with the lock-tab oriented toward the bottom of the DSP 322ua and push firmly until the connector locks into place (usually an audible "click" can be heard). Connect the other end to the appropriate QSCControl.net network port.

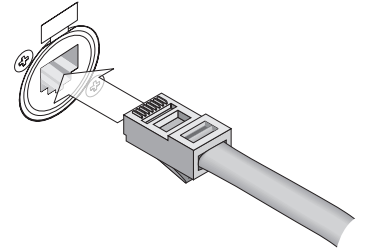

QSCControl connection: accepts ruggedized or normal shell-less RJ45 plugs.

Analog Universal Audio Inputs

Eight balanced audio inputs are provided, **CH 1 INPUT - CH 8 INPUT**. They accept everything from mic level to line level signals and are equipped with software-selectable +48V phantom power. Plug the input signal terminal block connectors into the input receptacles. Connection pin-out is printed on the rear label for reference. Refer to the illustrations for balanced and unbalanced connections. Use balanced audio inputs whenever possible.



Each input has software-selectable +48V phantom power. Use caution when connecting equipment (particularly unbalanced equipment).

Analog audio input and output- balanced connection.

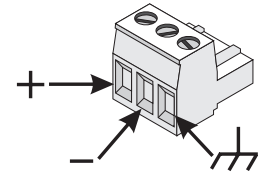

Analog audio input and output- unbalanced connection. Note jumper wire between - and ground.

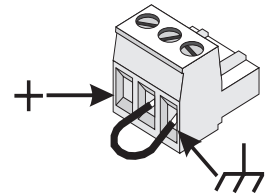

Analog Audio Outputs

Eight balanced audio outputs are provided, **CH 1 OUTPUT - CH 8 OUTPUT**. Plug the output signal terminal block connectors into the output receptacles. Connection pin-out is printed on the rear label for reference. Refer to the illustrations for balanced and unbalanced connections. Use balanced audio outputs whenever possible.

Omni In

The six **Omni In** connectors are two-pin terminal block connectors. They accept contact closure, TTL logic signals, 0-5 VDC control voltages, or 10k ohm variable resistors. The contact closure and logic devices accommodate on/off or state-change events; the variable resistor input provides full 8-bit resolution allowing for incremental-change events. Refer to the illustrations for connection recommendations. NOTE! +48 volts is the absolute maximum that can be applied to the + pin without damage. Voltage is with respect to chassis or the - pin.

Omni In connections. Variable input must be 10k ohm variable resistor. Contact closure input can be a switch or relay contacts. These inputs can operate software "devices". Negative (-) terminal is at chassis potential.

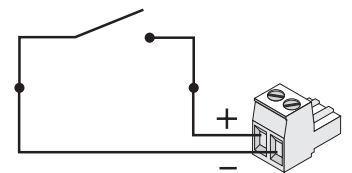
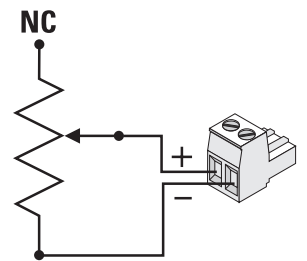

Logic Out

The four **Logic Out** connectors are two-pin terminal block connectors. They provide CMOS logic level compatible signals for external devices.

Logic Out connections. Negative (-) terminal is at chassis potential. Positive (+) terminal logic level is switched using software.

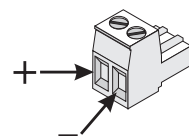

Relay Out

Two sets of relay contacts are provided, RELAY OUT 1 and RELAY OUT 2. Contacts are floating and rated for 30VDC, 1A. There is one common terminal, one normally-closed contact terminal and one normally-open contact terminal. These are labeled as *C*, *NC* and *NO* on the rear panel. When the relay is not energized, the *C* terminal is connected to the *NC* terminal and the *NO* terminal is not connected; when the relay is energized the *C* to *NC* connection is opened and the *C* to *NO* connection is closed.

Relay Out connections.
Refer to text, at left, for explanation.

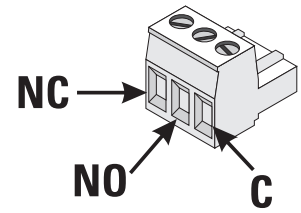

RS-232

The RS-232 is a utility serial port for accessing certain diagnostic features and setup. Connect to an available COM port on your PC and communicate using a terminal control program such as Windows Hyperterminal.

Use a normal serial data cable with a DB-9 male plug to connect to the DSP 322ua. To connect the cable, orient the connector properly, then push into the receptacle until it is firmly seated; tighten the retaining screws "finger tight". Communications should be 9600 baud, no parity, 8 data bits, 1 stop bit, and flow control Xon/Xoff.



LED Indicators

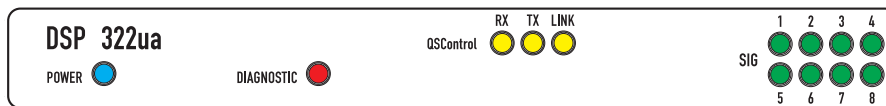

When the DSP 322ua is plugged into a properly functioning AC outlet, it will power up and briefly display a welcome screen on the LCD display.

POWER Indicator- This blue indicator illuminates when the DSP 322ua is plugged into a properly functioning AC source. There is no power switch on the DSP 322ua. This helps to prevent accidental system shutdowns.

DIAGNOSTIC Indicator- This red diagnostic LED reports several possible operational conditions. During boot-up, it is used to continually blink a "dot-dash" pattern if the power-on memory self-test fails. During normal operation, if any non-recoverable system fault occurs, the diagnostic indicator will remain on, requiring a power restart. If this condition persists, contact QSC's Technical Services for assistance.

The diagnostic LED is also used to indicate an update is in progress during a remote firmware update cycle. First, the LED will blink slowly, indicating the memory erase cycle, then it will blink rapidly, indicating the memory write cycle. **NOTE! During a firmware update, it is critical the unit remain powered on for the entire process in order to complete successfully.**

The diagnostic LED may also be controlled by using the QSCControl.net software. This feature is particularly helpful for identifying a particular unit.

(continued, next page)

LED Indicators (continued)

QSCControl Status (Port) Indicators- There are three LEDs on the front and rear panels labeled RX, TX and LINK. These indicate the status for the QSCControl.net network. Their functions are described below.

RX (receive)- This indicator illuminates any time the DSP 322ua receives data from the network.

TX (transmit)- This indicator illuminates whenever the DSP 322ua transmits data onto the network.

LINK STATUS- The corresponding indicator illuminates when the DSP 322ua is connected to an operating network.

SIGNAL indicators- These indicators will illuminate green for input signals -40dB to -10dB below full scale; yellow for signals between -10dB to -2dB below full scale; red for -2dB to full scale (or clip).

LCD Display and Controls

The DSP 322ua has a 2 line X 16 character LCD display. The display and the multi-function push-button switches on either side provide data access and editing capability. The push-button switches on either side of the display are used to navigate through the menus. The rotary select/accept knob is active for many displayed items allowing you to scroll through choices by rotating the control, and accepting choices (entering) by pushing in on the control.

The accessible menus and sub menus may appear differently than the example shown. Software updates may occasionally improve the interface. The basic navigation flow for the DSP 322ua menu system is shown on the following page.

Front Panel Password Lockout

The password lockout provides the ability to restrict access to all of the editable parameters available on the LCD front panel. This feature is enabled or disabled via QSCControl.net software only (refer to the "General Tab" area and click on the "Front Panel Password" button). When the lockout feature is enabled, all front panel LCD functions are readable, but editing of parameters is now password protected. While in this mode, any attempt to edit a parameter requires the user to enter the Front Panel Password. The default factory password is "qsc". The password is stored in the DSP unit and can be changed using the QSCControl.net software.

Once the password has been correctly entered, the DSP will allow edits to the parameters.

After 5 minutes of inactivity, the DSP will automatically reset the Front Panel Password lockout. Re-entry of the password will be required to resume editing.

The lockout mode can be deliberately disabled via the "Disable Edits" checkbox in the Front Panel Password menu of the QSCControl.net software.

LCD Navigation Map

Use rotary data wheel to edit data. Rotate to move cursor and push to accept change.

Left side buttons have screen dependent functions.

This read-only screen is the "out of the box" default display after power up. This is the most desired information when first setting up a network system. Once user moves to a different screen, the last screen accessed becomes the new power up default.

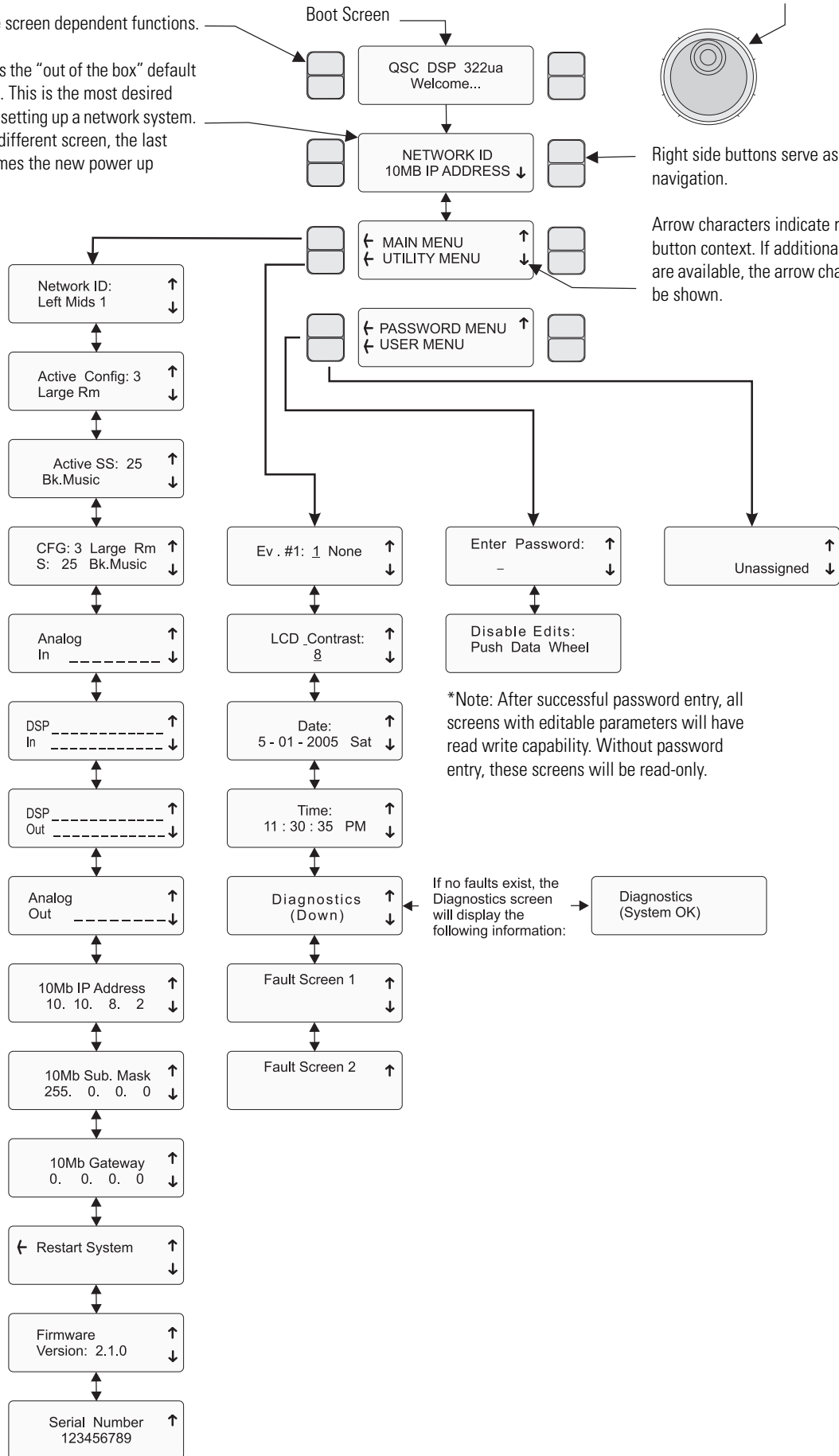
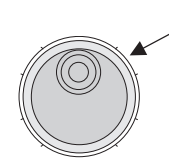

Right side buttons serve as up/down navigation.

Arrow characters indicate right side button context. If additional menus are available, the arrow character will be shown.

*Note: After successful password entry, all screens with editable parameters will have read write capability. Without password entry, these screens will be read-only.

If no faults exist, the Diagnostics screen will display the following information: Diagnostics (System OK)

Getting Started

This section outlines one of the simpler methods of getting familiar with your DSP 322ua and the QSCControl.net software. The goal of this procedure is to get your computer and the DSP 322ua connected and communicating and the QSCControl.net software installed and running. After the software is installed and running, refer to the software's Help file for all software related operation/issues. Note! The default password for the DSP 322ua is "qsc" (no quotes, lower case).

- 1-** Turn off the computer and unplug the power cord from the DSP 322ua.
- 2-** Connect a CAT-5 crossover cable from the computer's network interface card (NIC) to the DSP 322ua QSCControl jack (example 1, page 5).
- 3-** Reconnect the power cord to the DSP 322ua (turn it on). Using the DSP 322ua LCD display and controls, navigate the menu to the IP Address and make a note of it. In steps 12 and on, you will need to change the IP address of the DSP 322ua or your PC.
- 4-** Turn on the PC and start Windows. You must have Administrator rights and be signed on as Administrator in order to install the QSCControl.net program. Ensure you are signed on to the computer as the Administrator.
- 5-** Place the QSCControl.net CD-ROM in your CD-ROM drive. The install wizard should start. If not, you can also select **Start** then **Run** and browse for the file named **setup.exe** from the CD.
- 6-** The installer queries the computer for available drive space and other information. If required MDAC library (Microsoft) files are not already on the computer, the library files are installed. You must accept the Microsoft software agreement in order to install the MDAC library. It may be necessary to reboot the computer after library installation.
- 7-** At the prompt for "Client/Server" selection, keep both Client and Server selected. This will be appropriate for general use.
- 8-** When prompted "Select Installation Folder", specify the installation directory or accept the default location.
- 9-** You will be prompted to select an installation accessible by everyone (non-secure) or an installation accessible only to you (secure). Select the appropriate Everyone or Just Me box and continue. Installation proceeds.
- 10-** Reboot only if your computer prompts you to do so.
- 11-** Select **Network Connections** in the control panel. Select **Properties**. Right-click **Local Area Connection**, and view its properties. Highlight the **Internet Protocol (TCP/IP)** tab and view its properties. You will see an entry field for the IP address. Decide whether you want to change the IP address of your computer to be similar that of to the DSP 322ua (easiest if you have many DSP 322ua units) or if you want to change the IP address of your DSP 322ua to be similar to that of the computer. This is a network management decision.
- 12-** Change the IP address of the DSP 322ua (or computer) to be compatible with that of the computer (or DSP 322ua). Typically, this is done by making the IP address of one of the devices 1 digit different in the last octet (group of digits in IP address). If changing the computer's settings, write down the current values, in case you want to revert later.
- 13-** The subnet mask address should be exactly the same for both the computer and the DSP 322ua. The Gateway address should not be altered as it is not used.
- 14-** After you are satisfied with all your settings, close all open windows and start the QSCControl.net program. Select **Start, All Programs, QSCControl.net, Venue Manager**.
- 15-** The login screen should open. The default password is "qsc" (lower case, no quotation marks). Select "Log on to Local Computer" and click OK.
- 16-** The QSCControl.net Venue Manager window will open. A Startup Tips screen will be visible the first time Venue Manager is launched. Optionally, the Startup Tips screen may be disabled by un-checking the box in it's lower left corner. It is **highly recommended** the user become familiar with each of the tips listed on this screen. After reviewing the tip(s), close the Startup Tips screen.

Getting Started (continued)

17- Select **Device, Add Device**, from the menu. A new window will open prompting you to name the device. Name it logically, such as DSP 1, or similar. Select the Device Type and select DSP 322ua. At the Password prompt, enter "qsc" (lower case, no quotation marks). This is the device password, separate from the software password. The default, in both cases, is "qsc", but you are free to change either or both. Enter the IP address of the DSP 322ua and click **OK**.

18- The DSP 322ua will now appear in the inventory root (left side of screen, first with a red "x", then a yellow exclamation point, then a normal icon). If the DSP 322ua does not eventually show in the inventory root, check that a crossover cable is used (only for DSP 322ua connected directly to PC), check the cable connections, verify IP addresses are set correctly, verify Subnet masks are set correctly, and verify AC power is properly applied to the DSP 322ua.

19- Click the "+" sign of the DSP 322ua in the inventory root, then the "+" sign of the Flashed Configs. Click on the config with the loud-speaker icon. A view of applicable device tabs will open. Click the DSP tab and the current DSP configuration of the DSP will be displayed.

20- Right click on the **Design Editor** icon in the lower left of your display; select "New". A new window opens; select DSP 322ua for the device type.

21- Click on **Help** to access the software's Help system. All software operation is covered in the on-line help file.

Operation of the DSP 322ua is accomplished with the included QSCControl.net software. No software operation is covered in this hardware manual. After installing your software, open the Help file and follow its recommendations. The software Help file includes the most recent information available for your DSP 322ua.

Operation

QSControl Port

The QSControl port operates on a 10BaseT Ethernet network. This port is one of the primary means for connecting QSControl.net to the DSP 322ua. The port may connect directly to a PC's 10BaseT or 10/100 (auto-sensing or auto-negotiating) network interface card using a crossover cable. Data from the QSControl port may also pass through network repeaters, network switches and routers. We strongly recommend the use of network switches to facilitate higher bandwidth and dedicated connections.

1 Minute Autosave Timer and Power Cycling

The active configuration has a special feature associated with it. Any changes made to a parameter during operation will start an internal timer which will trigger an automatic save of the configuration data. The save procedure begins after 1 minute of parameter change inactivity. If the DSP322ua is then power cycled, upon restart, the previous settings data will be preserved in the active configuration.

Utility/Diagnostic Functions

Safe Mode Switch

Location of Safe Mode switch: The front panel has a small access hole on the left side, just left of the Power indicator. It is not labeled to help prevent accidental use. The Safe Mode switch can be operated by using a paperclip (or similar item) inserted into the access hole and pushing.

Safe Mode: Use if the DSP 322ua becomes inoperable (or behaves in completely unexpected ways) after updating firmware.

If the DSP 322ua operates in an unexpected way or is not responding to any communications after a new firmware file is uploaded to it, it is likely the file was corrupted during transfer. If this occurs, there is a "backup" program in the DSP 322ua that will enable you to communicate with it.

How to put the DSP 322ua into Safe Mode:

- 1-** Turn off the power to the DSP 322ua by unplugging it from the AC outlet.
- 2-** Depress the Safe Mode switch and keep it depressed while plugging the unit back in (power on).
- 3-** The DSP 322ua is now in "safe mode". You may release the switch.

You should now be able to re-establish limited TCP/IP communications with the DSP 322ua. Once communication has been re-established, the file transfer can be tried again or the old application file used until the source of the data transfer problem can be found. Also, QSControl.net WILL NOT communicate with the DSP 322ua if it is in "safe mode". You may communicate only using TFTP, Telnet, or RS-232.

RS-232 Serial Port I/O Interface

The RS-232 connector on the rear panel is used as a serial port input/output (I/O). This I/O port is used for accessing Ethernet/IP settings, stand alone control capabilities, system "health" data, firmware version information and other related data.

Should any system problems arise, the data that may be accessed through this interface can help to track down the problem. The most common items that might be used are "Display Network Settings" and "Enter Network Setup". Many of the remaining selections would typically be used for troubleshooting purposes along with a QSC technical representative prompting you to access particular menu items so the data can be interpreted.

Connection is made using a normal serial cable between your computer's serial port and the RS-232 port of the DSP 322ua. Once properly connected, a "dumb-terminal" program (such as *Hyper Terminal*, a widely used version on most Windows-based PC's) is started and communication established between the PC and the DSP 322ua.

Following is the basic procedure for starting up *Hyper Terminal*, naming the connection, specifying the communications settings and an example of "what you should see" for a text-menu once the communications link has been established. If programs other than *Hyper Terminal* are used, you will need to follow your software's instructions for establishing communications through your PC's COM (serial) port.

Utility/Diagnostic Functions (continued)

RS-232 Communications Procedure:

- 1) Connect the **RS-232** port of the DSP 322ua to an unused serial port (COM port) of a PC using a normal (straight-through) serial cable.
- 2) Open the **HyperTerminal** program. This program is usually started by clicking the Windows **Start** icon, selecting **Programs**, then **Accessories, Communications**, and finally, highlighting the **Hyper Terminal** folder and clicking on its icon.
- 3) After starting **Hyper Terminal**, a **Connection Description** window will pop-up. It will require that you name your connection. Enter a name for your new connection (example: *DSP 322ua*) and click **OK** to continue.
- 4) Next, **Hyper Terminal** needs to know how to “talk” to the DSP 322ua. This selection depends on which port on your PC the cable is connected to. Ignore the first three entry fields (phone number information) and go directly to the **Connect using** entry field and click on the down arrow for the drop-down menu selection. Select the port the DSP 322ua is connected to and click **OK** to continue. The **Properties** window should appear next.
- 5) The **Properties** window for the selected *COM* port should now be active. For the Port Settings, use the following information so communication between the DSP 322ua and the computer is in the same “language”.
 - Bits per Second:** 9600
 - Data Bits:** 8
 - Parity:** none
 - Stop Bits:** 1
 - Flow Control:** Xon/Xoff

Once you have set the properties as outlined, click *OK* to continue. If all the connections and communications settings are correct, the main **Hyper Terminal** window will open.

- 6) The **Hyper Terminal** main window will appear next, but blank. Type the letter “h” (for help) and then the “Enter” key. This will prompt the DSP 322ua to post its menu text. The “h” key is the Help prompt for the DSP 322ua. A text menu will appear. This is sent by the DSP 322ua and will detail your options and instructions for changing the address information.

From this main-menu you will need to make your menu choices and follow the instructions in the following sub-menus or screens. Although many of the instructions and tests may not pertain to a specific setup or troubleshooting situation, you may be asked to run certain tests by a QSC technical representative. The results of these tests will help to troubleshoot any problems.

The most common user item that might require settings to be changed would be the IP address information. This would be useful if the IP address was inadvertently changed to an unrecognized address and subsequently you were unable to “talk” to the DSP 322ua over the network. This situation would require the **Display Network Settings** and **Enter Network Setup** items to be accessed for re-assigning a valid IP address.

IP ADDRESS ASSIGNMENT- ONLY REQUIRED FOR ATTACHING TO EXISTING NETWORKS! DO NOT CHANGE THE COMMUNICATIONS SETTINGS OF THE DSP 322ua UNLESS CERTAIN OF YOUR ACTIONS. THE FACTORY-PROGRAMMED IP ADDRESS CAN BE ACCESSED USING THE FRONT PANEL DISPLAY MENU SYSTEM. RECORD THIS IP ADDRESS SHOULD YOU NEED TO RETURN TO THE INITIAL SETTINGS.

Telnet Access

The RS-232 features can also be accessed via Telnet. The Microsoft Telnet application is a Windows program. Consult Windows documentation for Telnet information.

Basic procedure for opening a Telnet session:

- 1- To open the Telnet session- Click **START**, select **RUN**, type “Telnet” followed by a space, then the IP address of the DSP 322ua you want to communicate with in the text box and click **OK**.
- 2- If the address entered was correct and network communications with the DSP 322ua are successful, the Telnet session should open.
- 3- Now you have the same options that are available in the Serial Port I/O (RS-232) interface section.

Preliminary Specification

	IN	OUT	THRU
Dynamic Range (AES-17, -60dB Method, all sensitivities)			
unweighted	>110dB	>112dB	>108dB
A weighted	>113dB	>115dB	>111dB
Distortion (20Hz-20 KHz, all sensitivities)			
Gain= 0 - 30dB	<0.008% THD+N	<0.009% THD+N	<0.009% THD+N
Gain >30dB	<0.05% THD+N	<0.009% THD+N	<0.05% THD+N
Crosstalk (20Hz - 20KHz)			
inter-channel (max)	>75dB		
inter-channel (typ)	>90dB		
intra-channel (max)	>85dB		
intra-channel (typ)	>100dB		
Frequency Response			
20Hz - 20KHz (max)	± 0.5dB		
20Hz - 20KHz (typ)	± 0.2dB		
Program Inputs			
Connector Type	8		
Type	3-pin "Phoenix Style" (a.k.a. "Euro Style") detachable terminal blocks		
Grounding	Electrically balanced		
Pinout	All shield terminals connected to chassis		
Input Impedance (nom.)	1:+ 2:- 3:CHASSIS GND		
Common-Mode Rejection	Balanced: 6.81k ohms Unbalanced: 13.6k ohms		
E.I.N.(max.)	20Hz - 20KHz (min.): >54dB, 20Hz - 20KHz (typ.): >60dB		
Input Sensitivities (variable)	150 ohm, 30dB: -124.5dBu 150 ohm, 60dB: -125.0 dBu		
Phantom Power (per IEC1938 (1996))	Vrms: 0.9 mV to 15.46 V dBu: -62.2 to +26dBu dBV: -64.4 to +23.7 dBV +48V (software-selectable)		
Program Outputs			
Connector Type	8		
Type	3-pin "Phoenix Style" (a.k.a. "Euro Style") detachable terminal blocks		
Grounding	Electrically balanced		
Pinout	All shield terminals connected to chassis		
Maximum Output Level	1:+ 2:- 3:CHASSIS GND 9V (rms), +21.2 dBu, +19 dBV		
Audio Converters			
	24 bit, 48KHz, in and out		
Mute			
	infinite attenuation		
Delay			
DSP 322ua in stand-alone mode			
Analog input through full DSP chain to analog outputs	2.354 milliseconds (Default Group Delay)		

Specifications are subject to change without notice.

Preliminary Specification

Relay Outputs

Connector Type	2 discrete floating relay switch outputs
Configuration	3-pin "Phoenix Style" (a.k.a. "Euro Style") detachable terminal blocks
Pinout	Electromechanical Relay
Switching Capacity (nom)	1:NC 2:NO 3: COM 1A 30VDC

Logic Outputs

Connector Type	4 discrete outputs
Configuration	2-pin "Phoenix Style" (a.k.a. "Euro Style") detachable terminal blocks
Pinout	Single-ended, TTL compatible 1:+(Signal) 2:-(CHASSIS GND)

Omni Inputs

Connector Type	6 discrete inputs for TTL logic, voltage control or passive resistive
Configuration	2-pin "Phoenix Style" (a.k.a. "Euro Style") detachable terminal blocks
Pinout	Single-ended, ground referenced 1:+(Signal) 2:-(CHASSIS GND)
Normal Operating Range	Reads signals between 0-5V nominally
Potentiometer Operation	Use 10K for full range
Voltage Tolerance	+/- 48V
Current Output	0.5mA with 10K pot (for passive resistive controls)

RS-232 Port

Female DB9 Connector

QSCControl.net

Neutrik Ethercon RJ45 Ruggedized Data Connector

Indicators

QSCControl.net Status	Yellow Link, Tx, Rx, front panel / Green Link, Tx, Rx, rear panel
Power	Blue, front panel
Diagnostic	Red, front panel
LCD Data Display	2 line x 16 character, backlit, front panel
Signal Presence	Tri-state (red, green, yellow), front panel

Dimensions

18.89" (479.8mm) W x 1.73" (43.9mm) H x 15.00" (381.1mm) D

Weight

9.94 lb. (4.51 kg)

Specifications are subject to change without notice.

How to Contact QSC Audio Products

Mailing address: QSC Audio Products, Inc.
1675 MacArthur Boulevard
Costa Mesa, CA 92626-1468 USA

Telephone Numbers:

Main Number	(714) 754-6175
Sales & Marketing	(714) 957-7100 or toll free (USA only) (800) 854-4079
Customer Service	(714) 957-7150 or toll free (USA only) (800) 772-2834

Facsimile Numbers:

Sales & Marketing FAX	(714) 754-6174
Customer Service FAX	(714) 754-6173

World Wide Web: www.qscaudio.com

E-mail: info@qscaudio.com
service@qscaudio.com

Warranty Disclaimer (USA only; other countries, see your dealer or distributor)

QSC Audio Products, Inc. is not liable for any damage to amplifiers, loudspeakers, or any other equipment that is caused by negligence or improper installation and/or use of this signal processing product. While QSC has endeavored to develop and produce the most dependable and robust 'network' audio product for your use, due to the myriad of network situations and equipment that may be encountered in its implementation, QSC cannot be held responsible for network conflicts and associated consequences that may result. For this reason, QSC strongly recommends that the network used for implementation of QSCControl products be completely separate from all other networks, data or otherwise. As such, should you elect to integrate QSCControl products with your existing network system, all risks attendant to such integration of QSCControl products with your existing network or network systems are assumed by you. While QSC strives to provide the highest quality technical solutions for networked audio products, in no event will QSC or its suppliers be held liable for any damages, consequential, incidental or otherwise, including any claims for lost profits and/or savings resulting from any attempted integration of QSCControl products with your networking systems. No agent, employee or representative of QSC has any authority to alter or modify in any manner, the disclosures and recommendations set forth herein.

QSC Audio Products 3 Year Limited Warranty

QSC Audio Products, Inc. ("QSC") guarantees its products to be free from defective material and / or workmanship for a period of three (3) years from date of sale, and will replace defective parts and repair malfunctioning products under this warranty when the defect occurs under normal installation and use - provided the unit is returned to our factory or one of our authorized service stations via pre-paid transportation with a copy of proof of purchase (i.e., sales receipt). This warranty provides that the examination of the return product must indicate, in our judgment, a manufacturing defect. This warranty does not extend to any product which has been subjected to misuse, neglect, accident, improper installation, or where the date code has been removed or defaced. QSC shall not be liable for incidental and/or consequential damages. This warranty gives you specific legal rights. This limited warranty is freely transferable during the term of the warranty period.

Customer may have additional rights, which vary from state to state.

In the event that this product was manufactured for export and sale outside of the United States or its territories, then this limited warranty shall not apply. Removal of the serial number on this product, or purchase of this product from an unauthorized dealer, will void this limited warranty.

Periodically, this warranty is updated. To obtain the most recent version of QSC's warranty statement, please visit www.qscaudio.com.

Contact us at 800-854-4079 or visit our website at www.qscaudio.com.

