

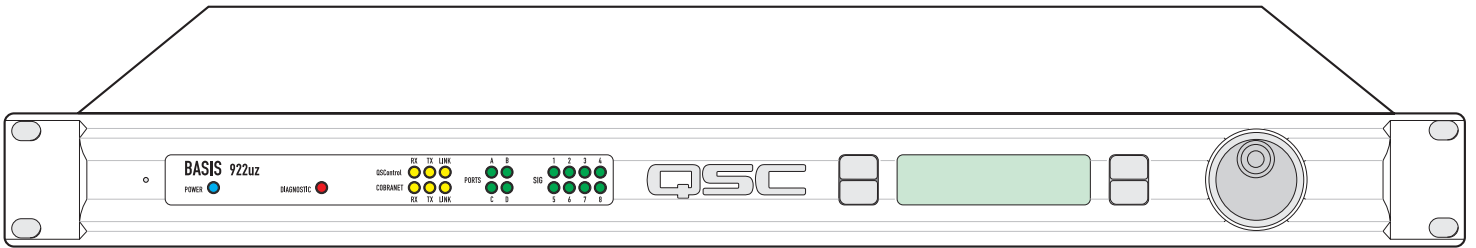

BASIS 922uz

8x8 CobraNet Enabled Control and Monitoring Signal Processor
Hardware Manual



TD-000197-00 rev.A

IMPORTANT SAFETY PRECAUTIONS & EXPLANATION OF SYMBOLS



The lightning flash with arrowhead symbol within an equilateral triangle is intended to alert the user to the presence of uninsulated "dangerous" voltage within the product's enclosure that may be of sufficient magnitude to constitute a risk of electric shock to humans.



The exclamation point within an equilateral triangle is intended to alert the user to the presence of important operating and maintenance (servicing) instructions in this manual.



SAFEGAURDS

Electrical energy can perform many useful functions. This unit has been engineered and manufactured to assure your personal safety. Improper use can result in potential electrical shock or fire hazards. In order not to defeat the safeguards, observe the following instructions for its installation, use and servicing.



CAUTION: To reduce the risk of electric shock, do not remove the cover. No user-serviceable parts inside. Refer servicing to qualified service personnel.



WARNING: To prevent fire or electric shock, do not expose this equipment to rain or moisture.

- 1- Maximum operating ambient temperature is 50°C (122°F).
- 2- Never restrict airflow through the device fan or vents. Please insure that the air intake and exhaust vents are unobstructed.
- 3- When installing equipment into rack, distribute the units evenly. Otherwise, hazardous conditions could be created by an uneven weight distribution.
- 4- Connect the unit only to a properly rated supply circuit. The BASIS 922uz is suitable for connection to 100 - 240 VAC, 47 - 440 hertz, with no special considerations other than the appropriate IEC power cord.
- 5- Reliable Earthing (Grounding) of rack-mounted equipment should be maintained.



LITHIUM BATTERY WARNING

THIS EQUIPMENT CONTAINS A NON-RECHARGEABLE LITHIUM BATTERY. LITHIUM IS A CHEMICAL KNOWN TO THE STATE OF CALIFORNIA TO CAUSE CANCER OR BIRTH DEFECTS. THE NON-RECHARGEABLE LITHIUM BATTERY CONTAINED IN THIS EQUIPMENT MAY EXPLODE IF IT IS EXPOSED TO FIRE OR EXTREME HEAT. DO NOT SHORT CIRCUIT THE BATTERY. DO NOT ATTEMPT TO RECHARGE THE NON-RECHARGEABLE LITHIUM BATTERY.

FCC INTERFERENCE STATEMENT

NOTE: This equipment has been tested and found to comply with the limits for a class B digital device, pursuant to part 15 of the FCC rules. These limits are designed to provide reasonable protection against harmful interference in a residential installation. This equipment generates, uses, and can radiate radio frequency energy and if not installed and used in accordance to the instructions, may cause harmful interference to radio communications. However, there is no guarantee that interference will not occur in a particular installation. If this equipment does cause harmful interference to radio or television reception, which can be determined by switching the equipment off and on, the user is encouraged to try to correct the interference by one or more of the following measures:

- Reorient or relocate the receiving antenna.
- Increase the separation between the equipment and the receiver.
- Connect the equipment into an outlet on a circuit different from that to which the receiver is connected.
- Consult the dealer or an experienced radio or TV technician for help.



Don't want to read the entire manual? Just want to dig right in? Go to page 18....

Introduction

The BASIS 922uz provides the digital audio transport, signal processing, control and status monitoring facilities needed to bind a group of amplifiers and loudspeakers into an integrated functioning system. In conjunction with QSCControl.net software, the BASIS 922uz enables the user to design, test and deploy professional audio reinforcement and distribution systems ranging in size from one to hundreds of channels.

Each QSC power amplifier connects directly to a BASIS 922uz via one of its four QSC DataPorts. All mission-critical elements of the BASIS-driven sound system are monitored. User-selected events are logged and loudspeaker protection features unique to BASIS such as QSC's power limiter are made possible through the DataPort functionality.

A standard Windows computer is the principle user-interface for controlling the overall BASIS/QSCControl system. However, the BASIS 922uz also offers a front panel interface for accessing a few critical functions.

A single QSCControl.net server computer can support several clients running QSC's latest Venue Manager software. Thus, the sound system can be operated via several computers, roaming wireless laptops, tablets, etc., all at the same time,

from anywhere a connection to the QSCControl.net network is available.

The QSCControl.net network can also be managed from a single computer running both the client and the server. Once all BASIS devices in a system are configured, a computer is no longer required on that system's network. All basic functions of the BASIS 922uz continue to operate with or without a control computer connected to the network.

The configurable DSP engine provides all of the functions of a signal chain, such as very flexible and precise cross-overs, delays, equalization, compression/limiting, etc.

Audio enters a BASIS 922uz either through analog universal inputs (mic to line level with software-selectable +48V phantom power) or from CobraNet source devices such as QSC's line of RAVE digital audio routers. Any combination of 16 CobraNet channels (selected from up to 4 bundles of 32 channels) can be routed into the 24 x 24 DSP engine. Any or all of the 24 DSP channels can also be routed to up to 32 CobraNet channels on the network.

Unlike other configurable DSP boxes, the intrinsic processing latency of the BASIS 922uz is both short and fixed at

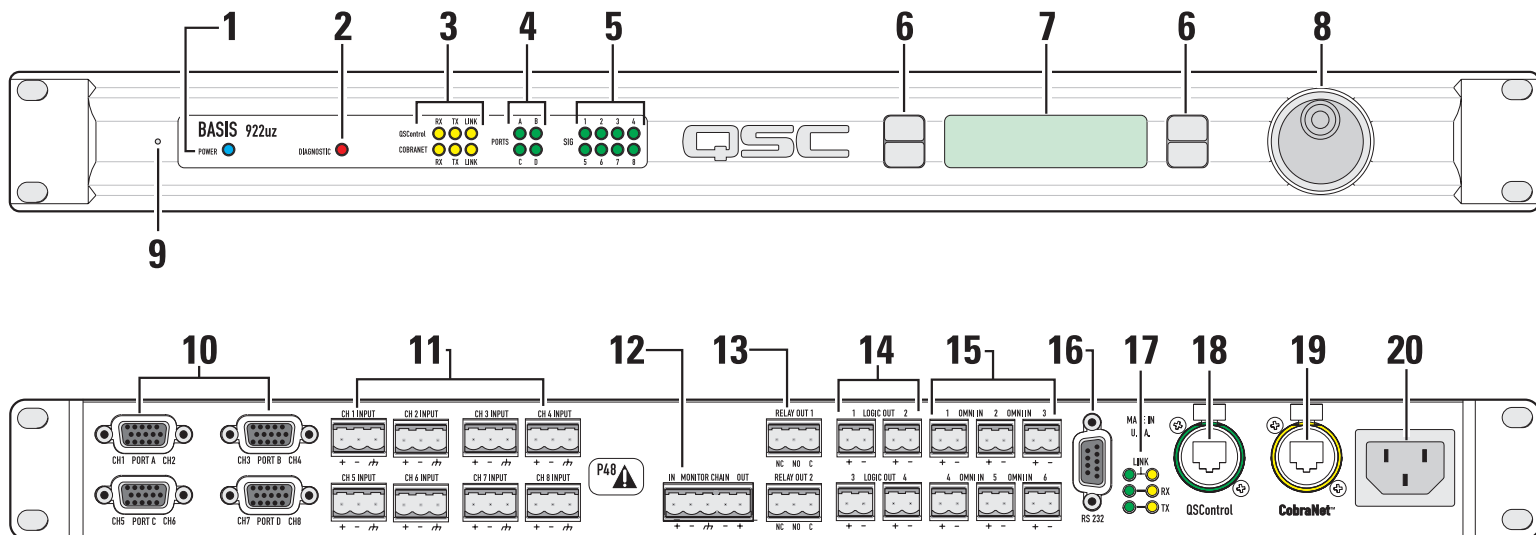

- | | |
|--------------------------------------|-----------------------------------|
| 1- Power indicator | 11- Mic/line inputs |
| 2- Diagnostic indicator | 12- Monitor chain in/out |
| 3- Network status indicators | 13- Relay outputs |
| 4- Port connection status indicators | 14- Logic outputs |
| 5- Signal presence/clip indicators | 15- Omni inputs |
| 6- Multi-function push buttons | 16- RS-232 port |
| 7- Display | 17- Network status indicators |
| 8- Rotary select/accept knob | 18- QSCControl 10BaseT receptacle |
| 9- Safe mode switch (recessed) | 19- CobraNet 100BaseT receptacle |
| 10- DataPorts | 20- IEC power inlet |



See page 14 for detailed descriptions.

Introduction (continued)

0.396 milliseconds. When analog input and analog outputs are used, the total delay is 2.354 milliseconds. The delay does not change regardless of the DSP configuration, unless the configuration intentionally adds more delay.

The BASIS 922uz also supports the new optional low-latency CobraNet feature that provides transport at only 2.66 milliseconds delay. Thus the delay from analog to analog across the network can be less than 6 milliseconds, fast enough not only for large audio distribution but for the most critical real-time live performance work.

Both software and firmware can be easily updated over the network. In the future, QSC will be adding new capabilities to both BASIS and QSCControl.net. Our latest code releases and access to up-to-date information on BASIS and QSCCon-

trol.net are available at www.qscontrol.net. We invite you to visit us there.

We've applied our many years of experience in supporting high-end installed sound with our previous system-building products such as RAVE, QSCControl, CM16a, DSP-3, DSP-4, and DSP-30. The BASIS 922uz brings all that technology together in one compact, powerful, easy to use system. We are confident that your new BASIS 922uz will provide years of dependable service and we hope it will help you, the system designer and implementer, to express your creative audio system ideas.

Block Diagram

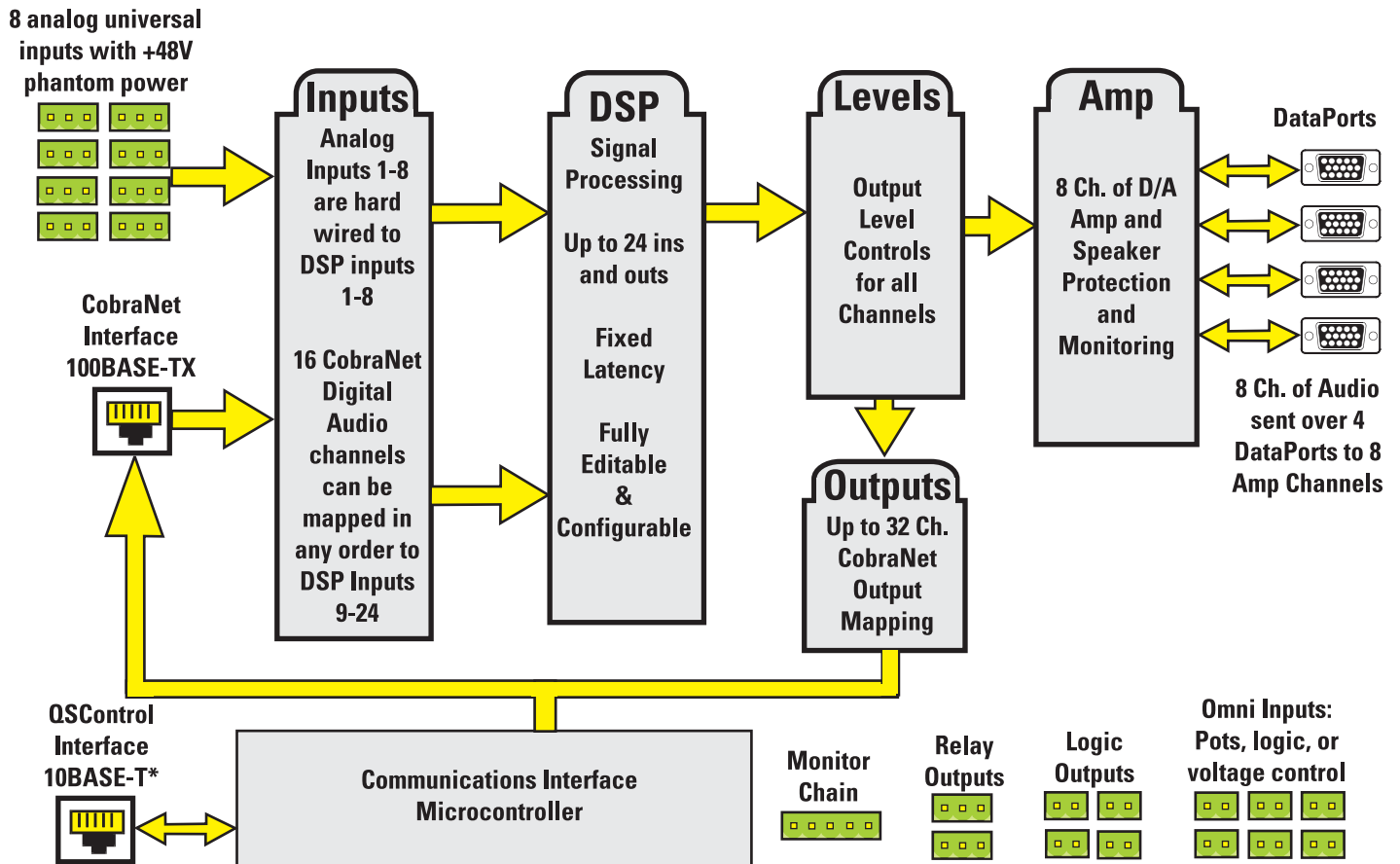

*Not used if control and audio run unified on CobraNet.

Introduction - Networking the BASIS 922uz

The BASIS 922uz has two RJ-45 network connection ports on the rear panel. One port is labeled "QSControl" and supports standard 10BASE-T Ethernet. The other port is labeled "CobraNet" and supports 100BASE-TX, also known as "Fast Ethernet". In the following sections we describe the use of these ports and show example network connection schemes.

The BASIS 922uz supports two distinct kinds of network activity; the first is audio transport via CobraNet, and the second is control and monitoring via QSControl.net. The user can choose to install one network for CobraNet traffic and a second separate network for QSControl.net traffic. We call this the "Two Wire Interface". Alternately, it is possible to run both control and audio traffic over CobraNet via the CobraNet port. In this case the QSControl port is unused. We call this the "Single Wire Interface".

Under the most demanding real-time control conditions and when using the lowest latency CobraNet settings, users may experience better QSControl.net performance using separate networks, especially when displaying a great many real-time meters. For most applications, separate networks won't provide any discernible benefits and will cost more. We therefore recommend using the Single Wire Interface when running CobraNet.

If your application uses only analog I/O without CobraNet, then you should use the QSControl port for QSControl.net traffic and ignore the CobraNet port.

Why CobraNet Needs Special Treatment:

Ordinary Ethernet traffic has no guaranteed time of delivery. Packets of information may arrive at their destination out of order and some may be delayed more than others. This is fine for E-mail and even for downloading MP3 files over the Internet. Everything ends up properly reassembled at the destination, but how long this takes will vary according to network loading, span, etc. In contrast, CobraNet is "real time" - it delivers audio with a minimal, consistent transmission delay. CobraNet is designed to use as much of conventional networking technology as possible while providing both guaranteed time of delivery and isochronicity - maintaining a phase-locked sample-accurate clock across the entire network. These requirements mean that ordinary unregulated Ethernet data cannot be freely mixed with CobraNet information. The two can coexist on the same wire, but only by adhering to the proper rules.

To learn more about CobraNet and appropriate network topologies, please visit <http://www.qscaudio.com/products/network/resources.htm> and <http://www.peakaudio.com/CobraNet/background.html>.

Notes on Network Systems Design:

As with any communications system, the reliability and performance of a local area network is intimately related to the designer's skill and knowledge in implementing a topology that is robust, efficient and standards-compliant. Proper network design is even more critical in distributed multimedia systems. Therefore, it is important for the system designer to realize that some conventional network practices must be avoided. Although each network design is unique and may carry its own performance requirements, compliance to the following three points will assist in building an audio network that is trouble free and efficient.

First, audio and conventional data communications deliveries should not exist on the same LAN or VLAN. The exception to this is the BASIS 922uz Single Wire Interface, which offers a solution for converging audio and QSControl.net onto the same LAN or VLAN. However, conventional communications, such as corporate networks, print services, e-mail and Internet access, should not exist alongside CobraNet audio and QSControl.net on the same LAN or VLAN. Further, CobraNet audio and QSControl.net data should not exist together on the same LAN or VLAN when implementing the Two Wire Interface. This is not to say that conventional communications cannot share the same network hardware with a BASIS 922uz. In fact, common network hardware, such as managed Ethernet switches and media converters, can service both BASIS 922uz products and conventional data communications equipment so long as the managed switch or media converter are partitioned into separate network domains. This is normally done by configuring a separate VLAN for each data type. (Some switches may allow individual port assignments or support partitions through DIP switch selection.)

Second, CobraNet audio must traverse either a repeater domain or a network switch domain. The point here is that the CobraNet port on a BASIS 922uz must connect directly to, and only to, either a repeater LAN or a switched Ethernet LAN. Hybrid networks containing both repeaters and switches are not permitted on the audio segment. Connecting the CobraNet port to a repeater that is in turn connected to a network switch poses an illegal and non-compliant condition. We recommend always connecting the QSControl and/or CobraNet port(s) directly to network switch ports.

Third, the BASIS 922uz and QSCControl.net system are targeted at network switch deployments. The consumer costs of Ethernet switches have continued to fall over the last several years and are now comparable with repeaters on a per port basis. In addition, the sophistication and scalability of network switches make them ideal for new installations. However, we do realize that designers may wish to add BASIS products to existing audio network installations that are built on repeater LAN topologies. This applies primarily to existing CM16a and RAVE networks. For this very reason we continue to support connectivity to network repeater hardware with the BASIS 922uz. Support for network repeaters exists only with the Two Wire Interface and only with the standard CobraNet forwarding latency. That is to say that the QSCControl port and the CobraNet port must be connected to separate repeater LANs. Even when properly configured, audio channel capacity is severely limited and both audio and control network expansion is limited by the respective capacity of each segment. In other words, scalability ceases to exist when bandwidth demands on the QSCControl.net segment approach 10 Mbps and demand on the CobraNet segment approaches 100 Mbps. Obviously, we recommend taking advantage of switch network technology whenever possible.

It should be noted here that while the CobraNet port on a BASIS 922uz is restricted to repeater LAN or switch LAN deployments, QSCControl.net is a TCP/IP standards-compliant network system and therefore supports operation on network repeaters, switches and routers. When implementing the Two Wire Interface, the QSCControl.net segment does not require a single topology data path and therefore repeaters, switches and routers may be assembled on the LAN in a hybrid fashion.

To learn more about network design rules and system compliance visit the QSC network resources page at <http://www.qscaudio.com/products/network/resources.htm>. To learn more about CobraNet design requirements and to obtain the CobraCAD system design utility visit the Peak Audio website at http://www.peakaudio.com/CobraNet/Network_Design.html.

All of this may seem daunting if you are new to networking. However, it all boils down to connecting a few simple cables between various networking devices. Most of the time it "just works". QSC helped pioneer CobraNet with our RAVE™ products and there are hundreds of installations all over the world, in theme parks, hotels, stadiums - everywhere. They run hum-free, sound great and are very reliable.

The following examples will help get you started, but they just scratch the surface of what can be achieved with advanced networking...

Example #1 - QSCControl.net X-over mode:

This is the simplest connection you can make between the BASIS 922uz and your computer. Use a CAT-5 crossover cable connected between the BASIS QSCControl port and your computer's Network Interface Card, (NIC). No network switch is required. With QSCControl.net server and client software installed and running on your computer you will be able to completely set up and monitor your BASIS 922uz.

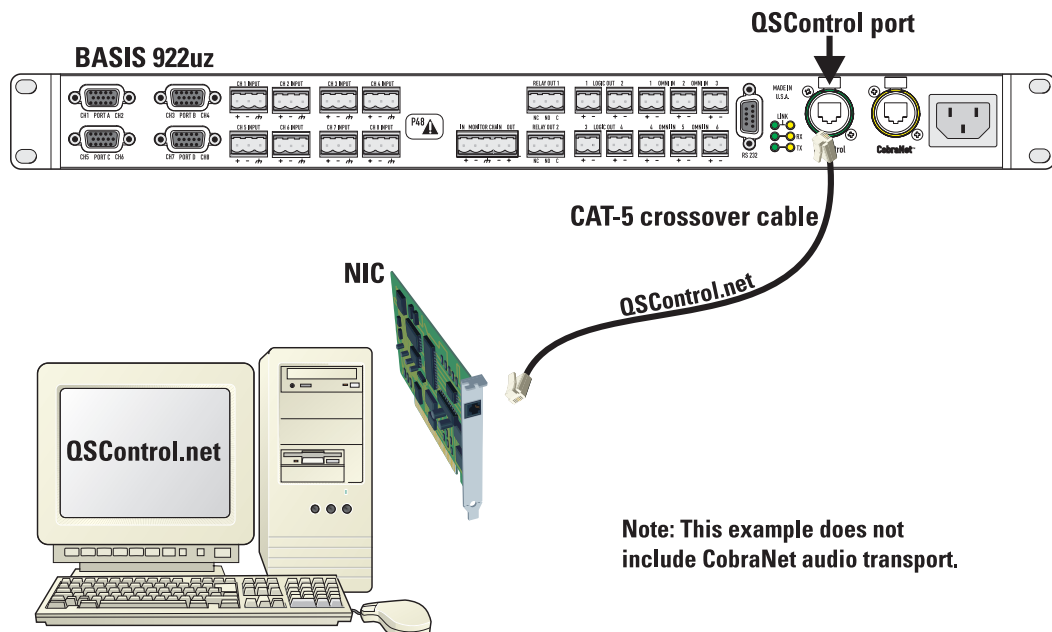

Example #2 - CobraNet X-over mode:

This is the simplest connection you can make between two BASIS boxes. Use a CAT-5 crossover cable connected between the CobraNet ports of each unit. No network switch is required. This connection allows audio to pass between the two BASIS boxes over CobraNet.

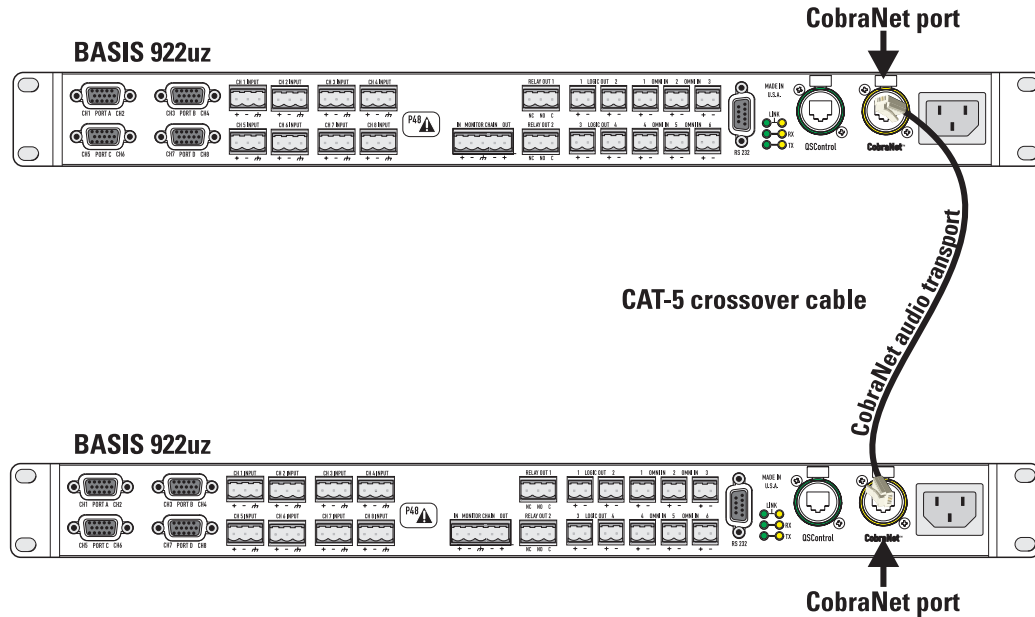

Note: This example does not include QSControl.net amplifier control and monitoring.

Combining example 1 and 2 lets you setup and monitor one box at a time, much as you would have to do using a point-to-point RS232 connection, while passing audio between them, all without a network switch. However, you would have to physically connect your computer first to one BASIS box and then to the other. With this elementary connection you don't have a true network. It is just like making RS-232 connections - except that performance is much better.

All the other examples are of proper networks and all require a network switch. On a proper network, you have direct access to all BASIS products all of the time without having to physically switch between them. You still get the great performance of TCP/IP over Ethernet. (And we believe QSC's advanced 4th generation networking software provides the best performance of any networked audio control system available today including Ethernet based systems from competitors.)

Example #3 - Single Wire Interface:

Here all QControl.net and CobraNet traffic shares the same single CAT-5 cable between the BASIS 922uz and an unmanaged Ethernet switch. The QControl.net system manages traffic flow efficiently and reliably so that all audio and control data is delivered to its appropriate destination anywhere on the network. Though the example shows only two BASIS 922uz units, as many devices may be connected as there are available switch ports. All BASIS units will be able to communicate simultaneously with the computer. All will have CobraNet audio. Switches can be connected to other switches to build larger networks; all of the normal networking principles apply. (Note: there must be at least two CobraNet devices online for any data - audio or control - to come out of the CobraNet port.)

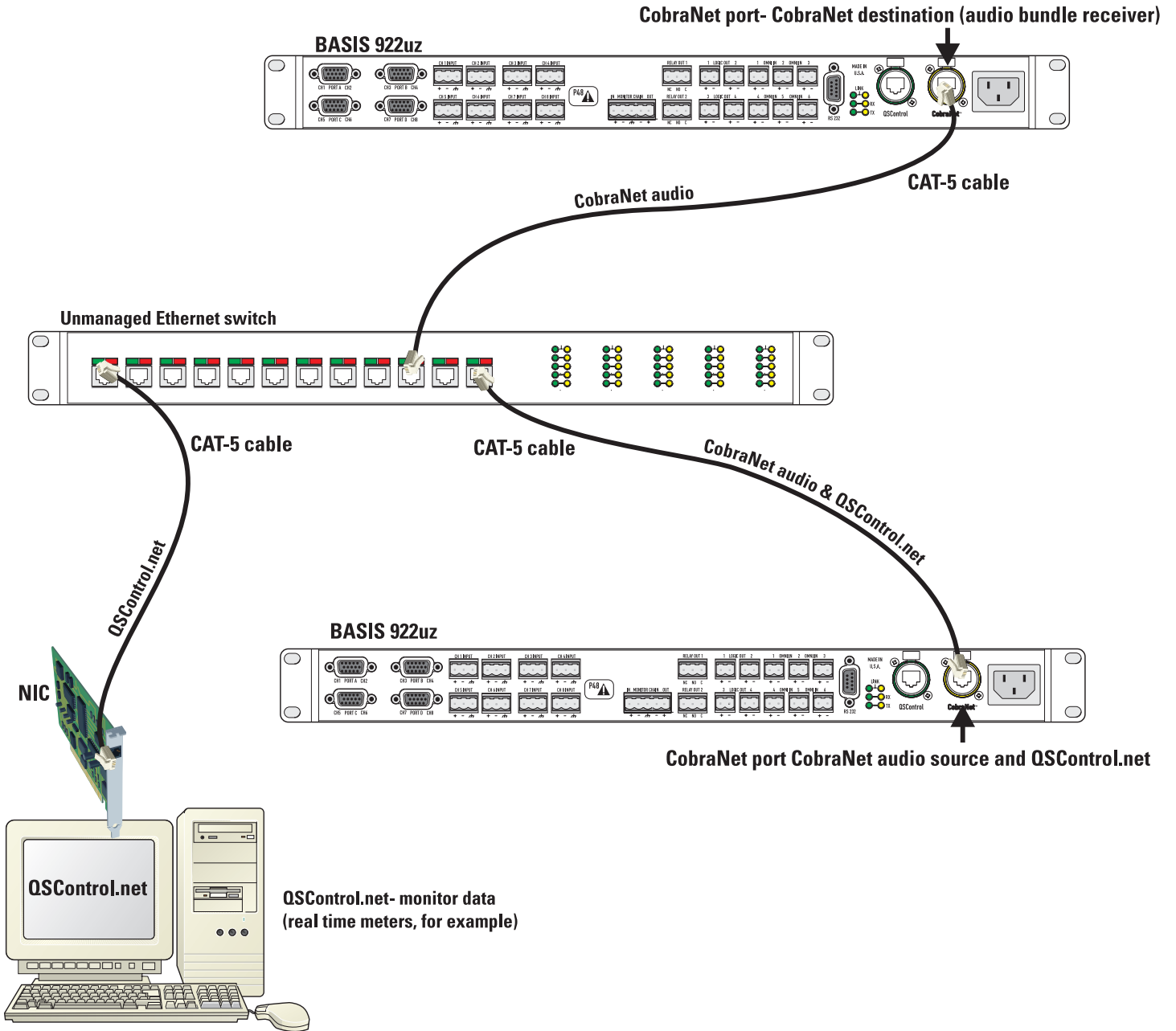

Example #4 - Two-Wire Interface (shared network hardware):

This example illustrates the Two-Wire Interface with a managed Ethernet switch. The switch is configured with multiple virtual local area networks (VLANs). Ethernet deliveries can only reach destination ports belonging to the same VLAN from which it was sourced. The figure shows a separate VLAN for QSControl.net traffic and a separate VLAN for CobraNet audio traffic. This configuration essentially provides a dedicated network for BASIS 922uz control and monitoring (including the system controller) and a second dedicated network for CobraNet audio. As with the previous example, as many BASIS units will be able to communicate with the computer. All will have CobraNet audio. Switches can be connected to other switches to build larger networks; all of the normal networking principles apply.

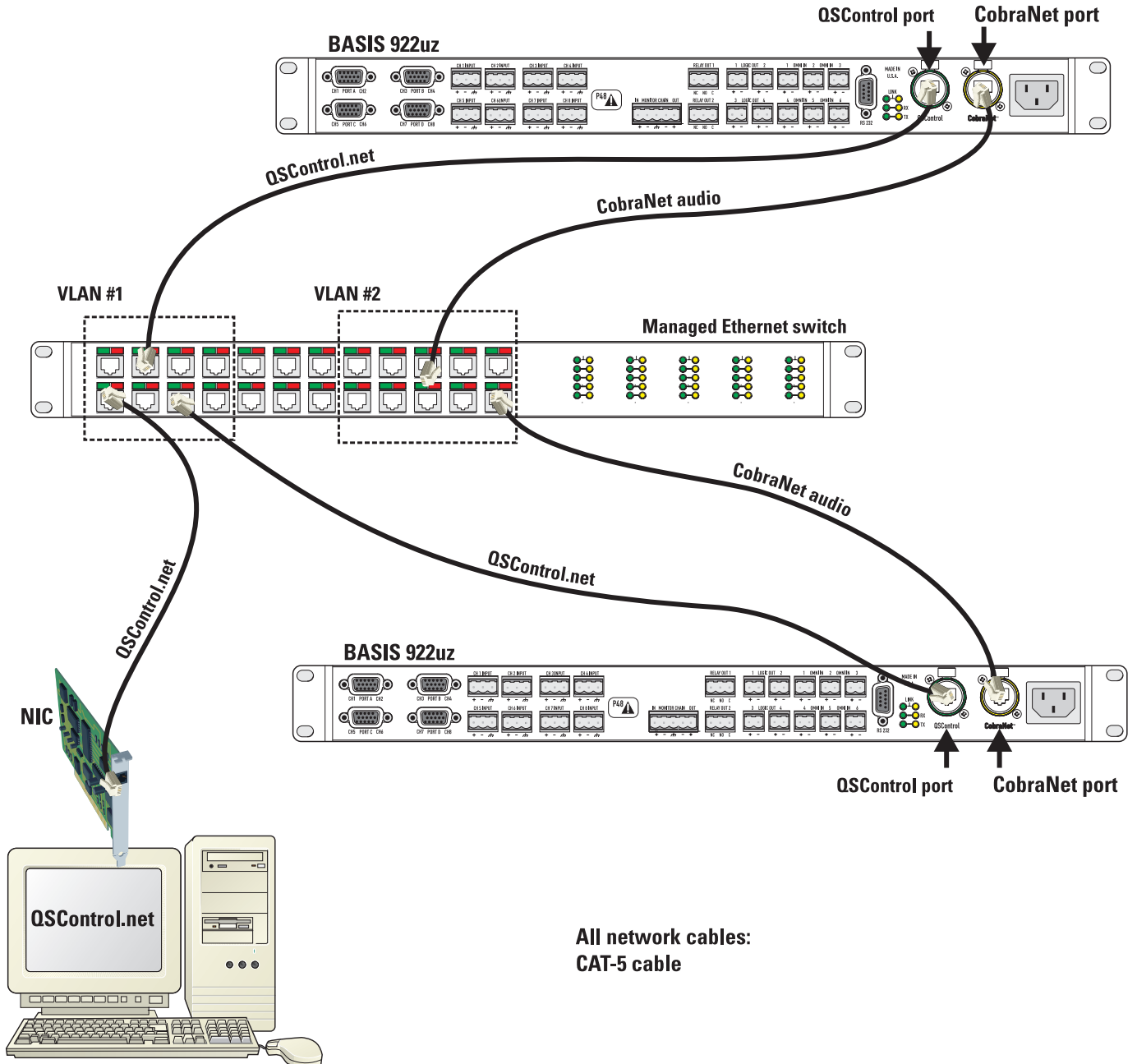

Example #5 - Two-Wire Interface (separate network hardware):

Example #5 is conceptually similar to example #4. The difference here is that separate networks are created by providing each local area network (LAN) with its own network switch. Therefore, traffic segmentation is physical rather than logical. Example #5 also provides an additional level of fault tolerance, although at the expense of additional network hardware. The figure shows a separate network switch for QSControl.net traffic and a separate network switch for CobraNet audio traffic. All of the previous comments regarding network expansion still apply.

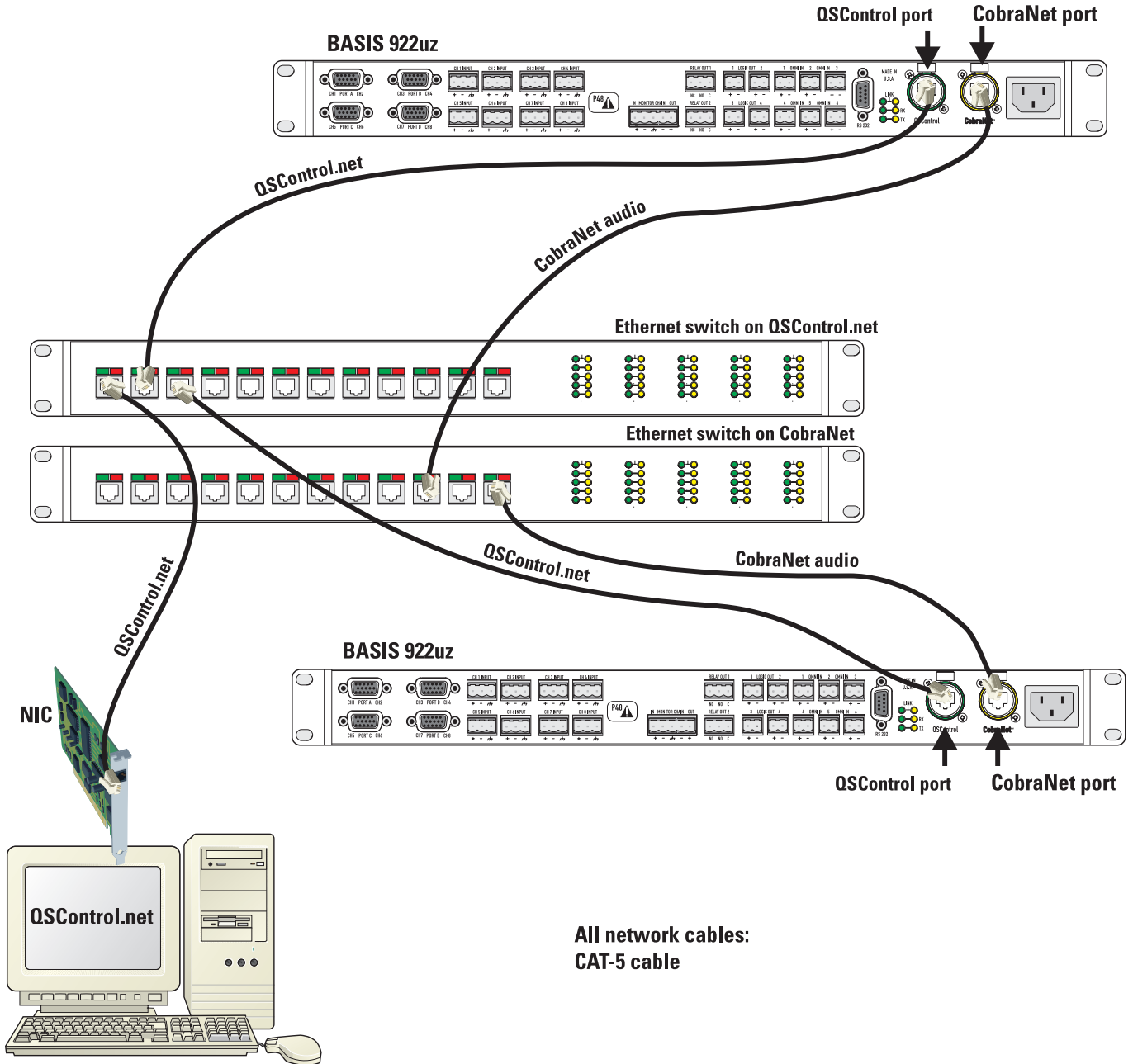

Unpacking

There are no special unpacking precautions. However, it is recommended you keep the original packing material for reuse in the rare event that service be required. If service is required and the original packing material is not available, ensure that the unit is adequately protected for shipment (strong box of appropriate size, sufficient packing material to prevent load-shifting or impact damage) or call QSC's Technical Services Department for packing material and a carton.

What is included in the carton:

Item	Description	Quantity
1	BASIS 922uz	1
2	Self-adhesive rubber feet	4
3	Hardware Manual (this document)	1
4	QSCControl.net Software CD	1
5	IEC Power Cord 3 x #18 AWG	1
6	3-pin terminal block connector	10
7	2-pin terminal block connector	10
8	5-pin terminal block connector	1

Mounting

The BASIS 922uz can be used in or out of an equipment rack. Rack mounting is optional. Adhesive rubber feet are included for non-rack mount installations. Use them to prevent the unit from scratching or marring support surfaces.

Rack Mounting

Rack mount the BASIS 922uz by supporting it from underneath while aligning the mounting holes with the threaded screw holes in the rails; install all four mounting screws and washers and tighten securely. Ensure use of all four mounting screws in order to minimize the chance of bending or distorting the rack mount ears. If the BASIS 922uz is to be transported while in a rack, we recommend supporting the rear of the chassis. This will help prevent the unit from being damaged from the increased mechanical stresses of portable and mobile use. The BASIS 922uz's chassis includes integral rear mounting tabs for securing to the rack mounting ears.

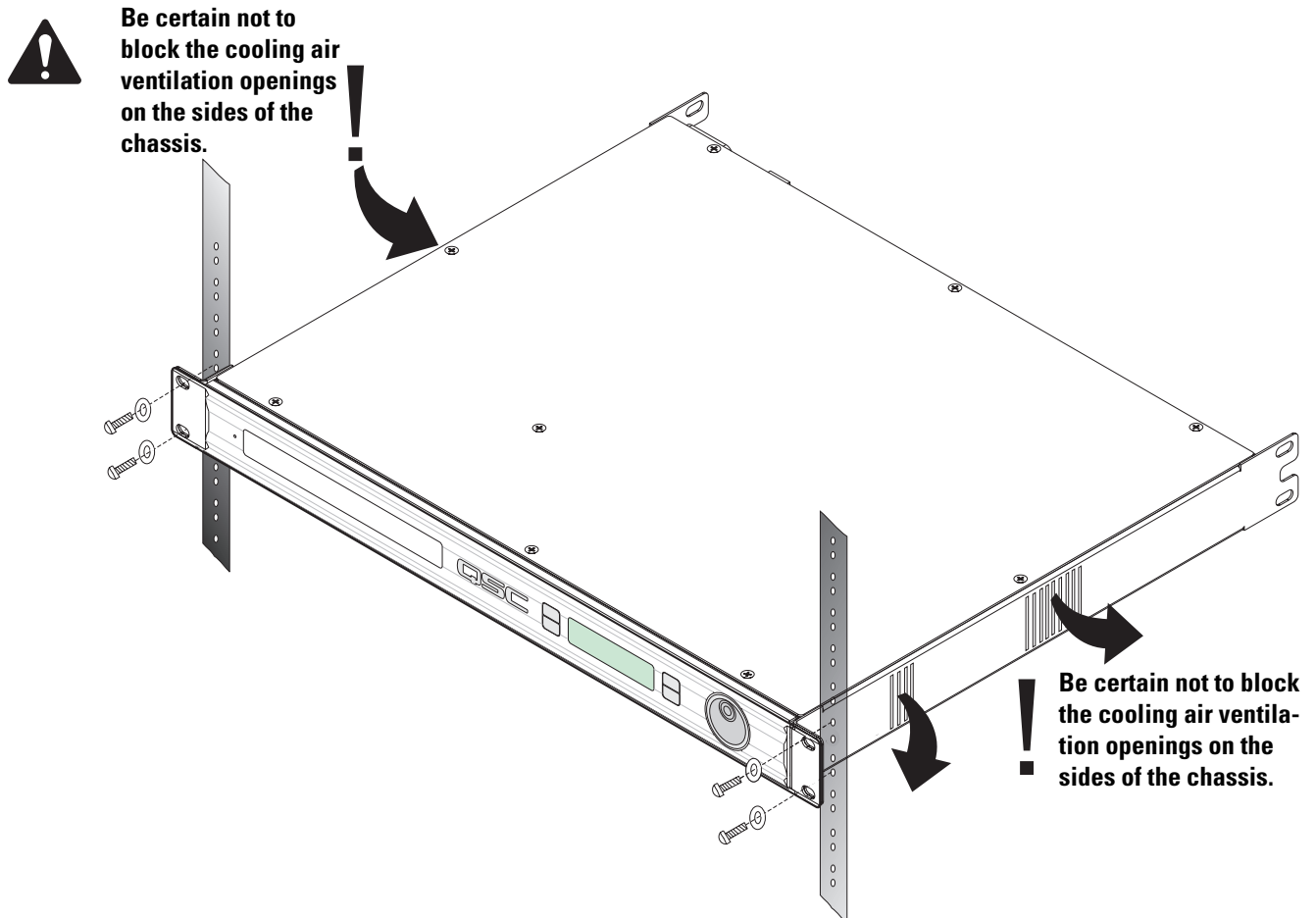

Computer Requirements & Software Installation

Installing QSControl.net is easy. All you need to do is choose the folder where the program is to be stored (the default setting is acceptable for most applications). We recommend your system meet the following minimum requirements:

- 1- IBM PC compatible computer with a Pentium 4 processor.
- 2- Processor speed of 1 GHz (2 GHz or faster recommended for systems with 30 or more BASIS/RAVE/DSP units).
- 3- 512 megabytes of RAM (1 gigabyte recommended for systems with 30 or more BASIS/RAVE/DSP units).
- 4- Hard drive with at least 500 MB of free space for the program and files you generate.
- 5- Display resolution of 1024 X 768, 16-bit color.
- 6- CD-ROM drive to install the software.
- 7- 10BaseT/100BaseTx network interface card
- 8- Windows XP Professional, XP Home, Windows 2000 SP2 (or better), or Windows NT4.0 SP6a operating system. Windows 95, 98 and ME platforms are not supported.

Note: If system is used for real-time adjustments and configuration of audio systems, we recommend all Windows Power Options (located in the Windows Control Panel) features be disabled. Display, hard drive, system standby and hibernation settings should be set to "Never". This avoids waiting for the system to "wake-up" if adjustment is needed after an elapsed period of time.

To Install QSControl.net:

- 1- Start your computer and start Windows.
- 2- If there are any programs running, please close them now. Be sure to leave Windows running.
- 3- Place the QSControl.net CD-ROM in your CD-ROM drive. You can also select **Start-Run** and browse for the file named setup.exe from the CD.
- 4- Click the Install QSControl.net button.
- 5- Follow the installation instructions on the screen.

To Uninstall QSControl.net:

- 1- Click the **Start** menu button and choose **Settings/Control Panel**.
- 2- Double-click the **Add/Remove Program** icon.
- 3- Select QSControl.net from the list, then click **Add/Remove**.
- 4- Click Yes to confirm you would like to uninstall QSControl.net.

General Information & Configuration Memories

Amplifier Setup

The QSC DataPort-equipped amplifiers connected to the BASIS 922uz must have their power switches in the “on” position. For initial testing, use the lowest useful gain setting until the system is operating as expected. After the system setup has been verified and tested, gain settings may be adjusted as required.

Network

The network should be operable and QSCControl.net software should be installed/running on the system controller computer.

CobraNet Connection Loss

If you are operating with a valid CobraNet network, and the connection to the network is disrupted, audio will momentarily mute, allowing the BASIS 922uz to synchronize with its internal clock. If CobraNet network connection is re-established, the audio will mute again while the BASIS 922uz synchronizes with CobraNet.

Configuration Memories

The BASIS 922uz has non-volatile storage locations that contain settings for the device as well as DSP signal flow. The storage locations make it possible to set up the BASIS for different situations and quickly recall the setup with or without QSCControl.net software using the front panel controls.

Connections

AC Power Cord

Insert the molded receptacle of the AC power cord into the AC power inlet on the back of the BASIS 922uz. Plug the AC line connector into the AC outlet. The power supply will accept from 100 to 240 Volts AC, 47 to 440 Hertz, without any changes. If a different type of IEC power cord is required than supplied with your 922uz, contact QSC's Technical Services Department.

CobraNet

Connect one end of a category-5 cable terminated with a RJ45 plug into the **CobraNet** receptacle. Insert the RJ45 plug into the receptacle with the lock-tab oriented toward the bottom of the BASIS 922uz and push firmly until the connector locks into place (usually an audible "click" can be heard). Connect the other end to the appropriate CobraNet network port.

QSControl

Connect one end of a category-5 cable terminated with an RJ45 plug into the **QSControl** receptacle. Insert the RJ45 plug into the receptacle with the lock-tab oriented toward the bottom of the BASIS 922uz and push firmly until the connector locks into place (usually an audible "click" can be heard). Connect the other end to the appropriate QSControl.net network port.

Analog Universal Audio Inputs

Eight balanced audio inputs are provided, **CH 1 INPUT - CH 8 INPUT**. They accept everything from mic level to line level signals and are equipped with software-selectable +48V phantom power. Plug the input signal terminal block connectors into the input receptacles. Connection pin-out is printed on the rear label for reference. Refer to the illustrations for balanced and unbalanced connections. Use balanced audio inputs whenever possible.



Each input has software-selectable +48V phantom power. Use caution when connecting equipment (particularly unbalanced equipment).

Omni In

The six **Omni In** connectors are two-pin terminal block connectors. They accept contact closure, TTL logic signals, 0-5 VDC control voltages, or 10k ohm variable resistors. The contact closure and logic devices accommodate on/off or state-change events; the variable resistor input provides full 8-bit resolution allowing for incremental-change events. Refer to the illustrations for connection recommendations. NOTE! +48 volts is the absolute maximum that can be applied to the + pin without damage. Voltage is with respect to chassis or the - pin.

Logic Out

The four **Logic Out** connectors are two-pin terminal block connectors. They provide CMOS logic level compatible signals for external devices.

Relay Out

Two sets of relay contacts are provided, **RELAY OUT 1** and **RELAY OUT 2**. Contacts are floating and rated for 30VDC, 1A. There is one common terminal, one normally-closed contact terminal and one normally-open contact terminal. These are labeled as *C*, *NC* and *NO* on the rear panel. When the relay is not energized, the *C* terminal is connected to the *NC* terminal and the *NO* terminal is not connected; when the relay is energized the *C* to *NC* connection is opened and the *C* to *NO* connection is closed.

CobraNet and QSControl connection. Accepts ruggedized or normal shell-less RJ45 plugs.

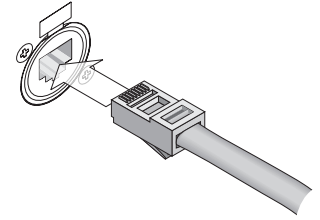

Analog audio input-balanced connection.

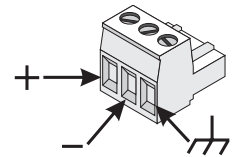

Analog audio input-unbalanced connection. Note jumper wire between - and ground.

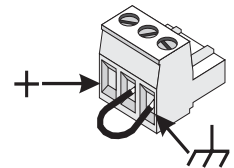

Omni In connections. Variable input must be 10k ohm variable resistor. Contact closure input can be a switch or relay contacts. These inputs can operate software "devices". Negative (-) terminal is at chassis potential.

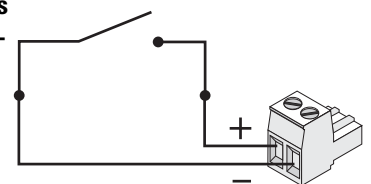
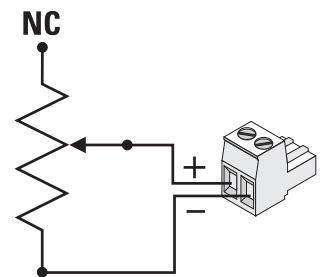

Logic Out connections. Negative (-) terminal is at chassis potential. Positive (+) terminal logic level is switched using software.

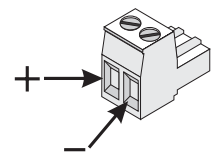

Relay Out connections. Refer to text, at left, for explanation.

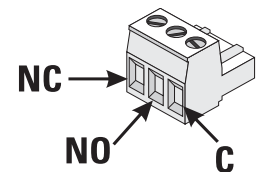

Monitor Chain

The **MONITOR CHAIN** connector is a 5-pin terminal block connector. Input and output connections are balanced. The center pin is the shield connection for *both* the input and output of the monitor chain. Connection is shown at right. The left-most + and - terminals are for monitor chain input signals, while the right-most terminals are for monitor chain output signals. When powered down, a relay connects the input to the output, thus bypassing the BASIS 922uz in the monitor chain.

Monitor Chain connection. See explanation, at left.

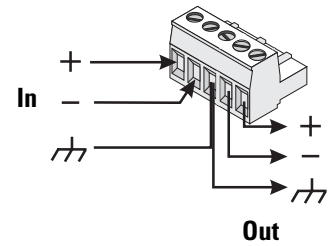

RS-232

The RS-232 is an optional utility serial port for accessing advanced features. Connect to an available COM port on your PC and communicate using a terminal control program such as Windows Hyperterminal.

Use a normal serial data cable with a DB-9 male plug to connect to the BASIS 922uz. To connect the cable, orient the connector properly, then push into the receptacle until it is firmly seated; tighten the retaining screws "finger tight". Communications should be 9600 baud, no parity, 8 data bits, 1 stop bit, and flow control Xon/Xoff.



Ports

PORT A through **PORT D** are QSC DataPorts. When using the BASIS 922uz with QSC DataPort-equipped amplifiers or QSC DSP products (DSP-3, DSP-4) connect to the BASIS 922uz using QSC DataPort cables. The 922uz supports up to eight channels of DataPort audio and amplifier status monitoring. This can be four 2-channel amplifiers or one 8-channel amplifier or other suitable combinations.

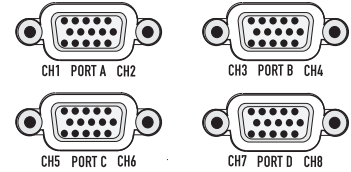

To connect the cable, orient the connector properly, then push into the receptacle until it is firmly seated; tighten the retaining screws "finger tight".

LED Indicators

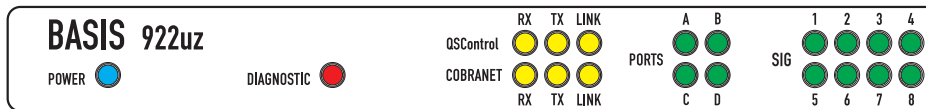

When the BASIS 922uz is plugged into a properly functioning AC outlet, it will power up and briefly display a welcome screen on the LCD display.

POWER Indicator- This blue indicator illuminates when the BASIS 922uz is plugged into a properly functioning AC source. There is no power switch on the BASIS 922uz. This helps to prevent accidental system shutdowns.

DIAGNOSTIC Indicator- This red diagnostic LED reports several possible operational conditions. During boot-up, it is used to continually blink a "dot-dash" pattern if the power-on memory self-test fails. During normal operation, if any non-recoverable system fault occurs, the diagnostic indicator will remain on, requiring a power restart. If this condition persists, contact QSC's Technical Services for assistance.

The diagnostic LED is also used to indicate an update is in progress during a remote firmware update cycle. First, the LED will blink slowly, indicating the memory erase cycle, then it will blink rapidly, indicating the memory write cycle. **NOTE! During a firmware update, it is critical the unit remain powered on for the entire process in order to complete successfully.**

The diagnostic LED may also be controlled by using the QSCControl.net software. This feature is particularly helpful for identifying a particular unit.

(continued, next page)

LED Indicators (continued)

QSCControl and CobraNet Network Status (Port) Indicators- There are two groups of three LEDs on the front and rear panels labeled RX, TX and LINK. One group is for the QSCControl network port and the other for the CobraNet network port. Their functions are described below. Note: Port indicators on rear panel are color coded to match the corresponding color-ring around the QSCControl and CobraNet RJ45s.

RX (receive)- This indicator illuminates any time the BASIS 922uz receives data from the corresponding network.

TX (transmit)- This indicator illuminates whenever the BASIS 922uz transmits data onto the corresponding network.

LINK STATUS- The corresponding indicator illuminates when the BASIS 922uz is connected to an operating network.

PORTS indicators- These indicators are labeled **A** through **D**. These indicators are either off, red, green, or yellow, depending on what is connected to the port. The indications are:

- off- nothing attached
- red- QSC DSP accessory attached
- green- QSC DataPort amplifier attached
- yellow- QSC DSP accessory and Amplifier combination attached

SIGNAL indicators- These indicators will illuminate green for input signals -40dB to -10dB below full scale; yellow for signals between -10dB to -2dB below full scale; red for -2dB to full scale (or clip).

LCD Display and Controls

The BASIS 922uz has a 2 line X 16 character LCD display. The display and the multi-function push-button switches on either side provide data access and editing capability. The push-button switches on either side of the display are used to navigate through the menus. The rotary select/accept knob is active for many displayed items allowing you to scroll through choices by rotating the control, and accepting choices (entering) by pushing in on the control.

The accessible menus and sub menus may appear differently than example shown. Software updates may occasionally improve the interface. Below is a the basic navigation flow for the BASIS 922uz menu system.

Front Panel Password Lockout

The password lockout provides the ability to restrict access to all of the editable parameters available on the LCD front panel. This feature is enabled or disabled via QSCControl.net software only (refer to the "General Tab" area and click on the "Front Panel Password" button). when the lockout feature is enabled, all front panel LCD functions are readable, but editing of parameters is now password protected. While in this mode, any attempt to edit a parameter will require the user to enter the Front Panel Password. The default factory password is "qsc". The password is stored in the BASIS unit and can be changed using the QSCControl.net software.

Once the password has been correctly entered, the BASIS will allow edits to the parameters.

After 5 minutes of inactivity, the BASIS will automatically reset the Front Panel Password lockout. Re-entry of the password will be required to resume editing.

The lockout mode can be deliberately disabled via the "Disable Edits" screen in the Front Panel Password menu of the QSCControl.net software.

LCD Navigation Map

Use rotary data wheel to edit data. Rotate to move cursor and push to accept change.

Left side buttons have screen dependent functions.

This read-only screen is the "out of the box" default display after power up. This is the most desired information when first setting up a network system. Once user moves to a different screen, the last screen accessed becomes the new power up default.

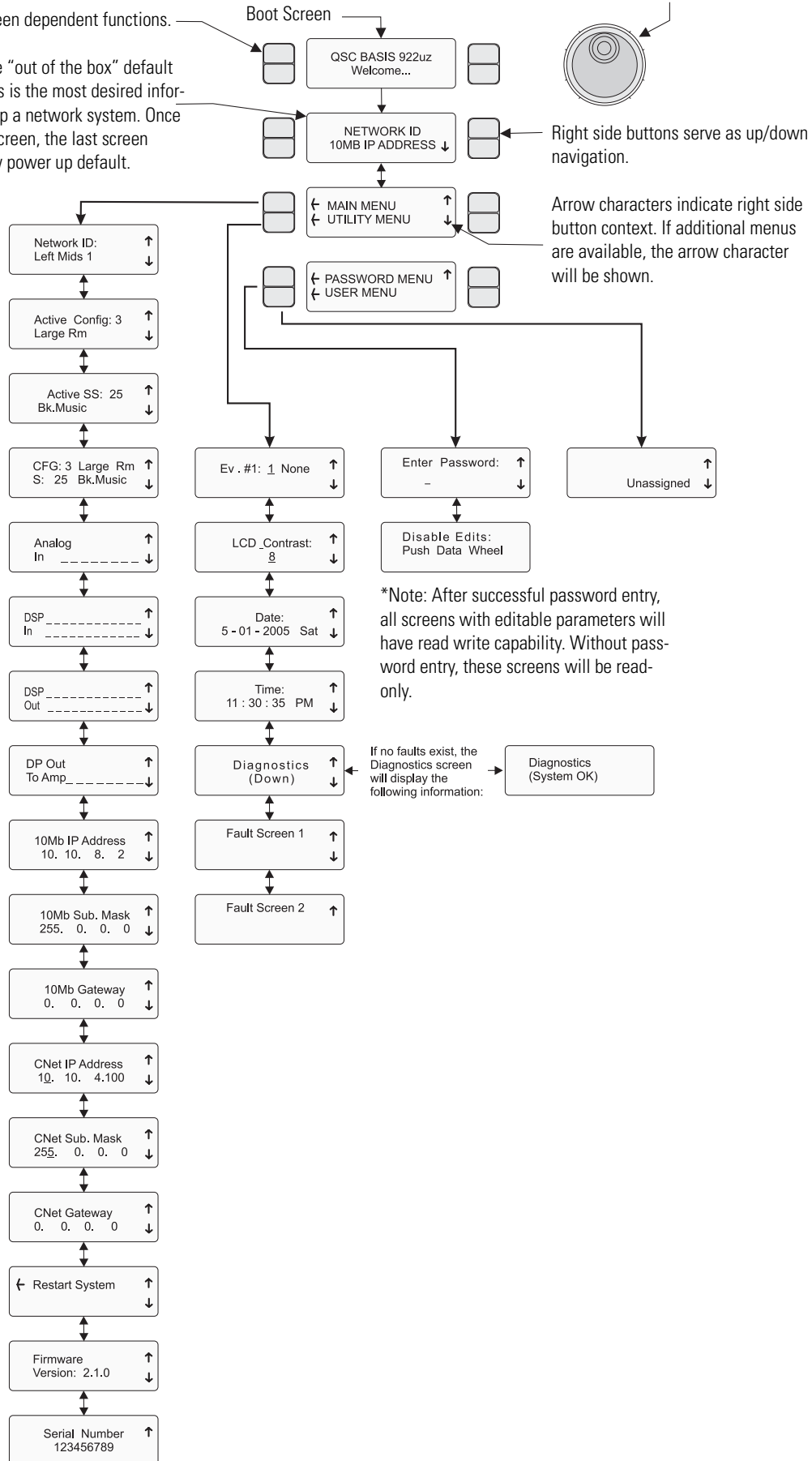

Getting Started

This section outlines one of the simpler methods of getting familiar with your BASIS and the QSCControl.net software. The goal of this procedure is to get your computer and the BASIS connected and communicating and the QSCControl.net software installed and running. After the software is installed and running, refer to the software's Help file for all software related operation/issues. Note! The default password for the BASIS is "qsc" (no quotes, lower case).

- 1-** Turn off the computer and unplug the power cord from the BASIS 922uz.
- 2-** Connect a CAT-5 crossover cable from the computer's network interface card (NIC) to the BASIS QSCControl jack (example 1, page 6).
- 3-** Reconnect the power cord to the BASIS 922uz (turn it on). Using the BASIS LCD display and controls, navigate the menu to the IP Address and make a note of it. In steps 12 and on, you will need to change the IP address of the BASIS or your PC.
- 4-** Turn on the PC and start Windows. You must have Administrator rights and be signed on as Administrator in order to install the QSCControl.net program. Ensure you are signed on to the computer as the Administrator.
- 5-** Place the QSCControl.net CD-ROM in your CD-ROM drive. The install wizard should start. If not, you can also select **Start**, then **Run** and browse for the file named **setup.exe** from the CD.
- 6-** The installer queries the computer for available drive space and other information. If required MDAC library (Microsoft) files are not already on the computer, the library files are installed. You must accept the Microsoft software agreement in order to install the MDAC library. It may be necessary to reboot the computer after library installation.
- 7-** At the prompt for "Client/Server" selection, keep both Client and Server selected. This will be appropriate for general use.
- 8-** When prompted "Select Installation Folder", specify the installation directory or accept the default location.
- 9-** You will be prompted to select an installation accessible by everyone (non-secure) or an installation accessible only to you (secure). Select the appropriate Everyone or Just Me box and continue. Installation proceeds.
- 10-** Reboot only if your computer prompts you to do so.
- 11-** Select **Network Connections** in the control panel. Select **Properties**. Right-click **Local Area Connection**, and view its properties. Highlight the **Internet Protocol (TCP/IP)** tab and view its properties. You will see an entry field for the IP address. Decide whether you want to change the IP address of your computer to be similar that of to the BASIS (easiest if you have many BASIS units) or if you want to change the IP address of your BASIS to be similar to that of the computer. This is a network management decision.
- 12-** Change the IP address of the BASIS (or computer) to be compatible with that of the computer (or BASIS). Typically, this is done by making the IP address of one of the devices 1 digit different in the last octet (group of digits in IP address). If changing the computer's settings, write down the current values, in case you want to revert later.
- 13-** The subnet mask address should be exactly the same for both the computer and the BASIS. The Gateway address should not be altered as it is not used.
- 14-** After you are satisfied with all your settings, close all open windows and start the QSCControl.net program. Select **Start, All Programs, QSCControl.net, Venue Manager**.
- 15-** The login screen should open. The default password is "qsc" (lower case, no quotation marks). Select "Log on to Local Computer" and click OK.
- 16-** The QSCControl.net Venue Manager window will open. A Startup Tips screen will be visible the first time Venue Manager is launched. Optionally, the Startup Tips screen may be disabled by un-checking the box in it's lower left corner. It is **highly recommended** the user become familiar with each of the tips listed on this screen. After reviewing the tip(s), close the Startup Tips screen.

Getting Started (continued)

17- Select **Device, Add Device**, from the menu. A new window will open prompting you to name the device. Name it logically, such as BASIS 1, or similar. Select the Device Type and select BASIS 922uz. At the Password prompt, enter "qsc" (lower case, no quotation marks). This is the device password, separate from the software password. The default, in both cases, is "qsc", but you are free to change either or both. Enter the IP address of the BASIS and click **OK**.

18- The BASIS will now appear in the inventory root (left side of screen, first with a red "x", then a yellow exclamation point, then a normal icon). If the BASIS does not eventually show in the inventory root, check that a crossover cable is used (only for BASIS connected directly to PC), check the cable connections, verify IP addresses are set correctly, verify Subnet masks are set correctly, and verify AC power is properly applied to the BASIS.

19- Click on the "+" sign of the BASIS 922uz in the inventory root, then the "+" sign of the Flashed Configs. Click on the config with the loudspeaker icon. A view of applicable device tabs will open. Click the DSP block and the current DSP configuration of the BASIS will be displayed. Default DSP routing is Analog Inputs 1-8 are routed to DataPorts 1-4, with each DataPort assigned 2 sequential channels (i.e. Analog Inputs 1 and 2 are routed to DataPort A, Inputs 3 and 4 are routed to DataPort B, etc....).

20- Right click on the **Design Editor** icon in the lower left of your display; select "New". A new window opens; select BASIS 922uz for the device type.

21- Click on **Help** to access the software's Help system. All software operation is covered in the on-line help file.

Operation of the BASIS 922uz is accomplished with the included QSCControl.net software. No software operation is covered in this hardware manual. After installing your software, open the Help file and follow its recommendations. The software Help file includes the most recent information available for your BASIS 922uz.

Operation

QSControl Port

The QSControl port operates on a 10BaseT Ethernet network. This port is one of the primary means for connecting QSControl.net to the BASIS. The port may connect directly to a PC's 10BaseT or 10/100 (auto-sensing or auto-negotiating) network interface card using a crossover cable. Data from the QSControl port may also pass through network repeaters, network switches and routers. We strongly recommend the use of network switches to facilitate higher bandwidth and dedicated connections.

CobraNet Port

The CobraNet port operates on a dedicated 100BaseTx (Fast Ethernet) network. The CobraNet port may connect directly to a PC's 100BaseTx or 10/100 (auto-sensing or auto-negotiating) network interface card using a crossover cable for the purposes of configuration when the BASIS 922uz is in the single-wire interface mode. During normal operation (passing audio) the CobraNet port must connect to a 100BaseTx or 10/100 or 10/100/1000 (auto-sensing or auto-negotiating) switch port. Optionally, the BASIS 922uz may connect to another CobraNet port using a crossover cable. When the BASIS 922uz is operating in the two-wire interface mode (described in following sections), the CobraNet port may be connected to a network repeater. Regardless of the interface mode, all CobraNet audio data must pass through only network switches or only network repeaters. Combinations of these devices will cause unreliable operation and are not supported. Likewise, the use of routers, gateways and ATM devices are not supported for the CobraNet audio path.

CobraNet Channel Density

The BASIS 922uz will support the acquisition of up to 32 channels via up to 4 inbound bundles (from the network). Of these 32 channels, any 16 may be selected to forward to the signal processing chain (DSP engine) in any one configuration.

The BASIS 922uz will support the delivery of up to 32 channels via up to 4 outbound bundles (to the network). Of these 32 channels, up to 24 may be unique (processed individually... or the result of mixed signals from the DSP engine). The remaining 8 channels (if used) will be copies of other channels.

CobraNet Channel Resolution

All CobraNet audio will be processed internally within BASIS 922uz at 24-bit resolution. The BASIS 922uz may receive any valid resolution off of the network. This is currently 16-bit, 20-bit and 24-bit. Audio via inbound bundles may be in any combination of these resolutions and the BASIS will process the data accordingly. All DACs will process 24-bit audio, though the least significant bits may be zero filled if the inbound audio format is less than 24-bit resolution.

The BASIS 922uz will support outbound (sourced onto the network) resolutions of 16-bit, 20-bit and 24-bit. The default outbound resolution is 20-bit.

CobraNet Terms and Conditions

Single-wire interface offers the best efficiency and ease of network configuration for most applications. The single-wire interface requires fewer network ports and less cabling. Single-wire interface refers to CobraNet audio, CobraNet control and monitoring and QSControl.net control and monitoring using the same network connection. This mode uses the CobraNet connection to provide all data communications to the BASIS product. In this mode, the port must connect to a 100BaseTx or 10/100 or 10/100/1000 (auto-sensing or auto-negotiating) link partner. Network repeaters will not be supported and all audio must pass through network switches only. A QSControl.net Venue Manager PC may connect to the network via a repeater or router.

Two-wire or dual-wire interface offers the greatest versatility in network design. Separate connections allow discrete networks and offer support for WAN topologies on the QSControl.net-side. Two-wire or dual-wire interface refers to CobraNet audio having a dedicated network link and QSControl.net control and monitoring having a dedicated network link. In this mode, the two ports (CobraNet and QSControl) must be connected to separate networks. By separate networks, we mean either physically separate hardware or the use of common hardware with partitioned or segmented network domains such as the use of VLANs. The dual-wire interface may support dissimilar network hardware for the two port connections (see rules above for CobraNet and QSControl port connections).

1 Minute Autosave Timer and Power Cycling

The active configuration has a special feature associated with it. Any changes made to a parameter during operation will start an internal timer which will trigger an automatic save of the configuration data. The save procedure begins after 1 minute of parameter change inactivity. If the BASIS 922uz is then power cycled, upon restart, the previous settings data will be preserved in the active configuration.

Utility/Diagnostic Functions

Safe Mode Switch

Location of Safe Mode switch: The front panel has a small access hole on the left side, just left of the Power indicator. It is not labeled to help prevent accidental use. The Safe Mode switch can be operated by using a paper-clip (or similar item) inserted into the access hole and pushing.

Safe Mode: Use if the BASIS 922uz becomes inoperable (or behaves in completely unexpected ways) after updating firmware.

If the BASIS 922uz operates in an unexpected way or is not responding to any communications after a new firmware file is uploaded to it, it is likely the file was corrupted during transfer. If this occurs, there is a "backup" program in the BASIS 922uz that will enable you to communicate with it.

How to put the BASIS 922uz into Safe Mode:

- 1-** Turn off the power to the BASIS 922uz by unplugging it from the AC outlet.
- 2-** Depress the safe mode switch and keep it depressed while plugging the unit back in (power on).
- 3-** The BASIS 922uz is now in "safe mode". You may release the switch.

You should now be able to re-establish limited TCP/IP communications with the BASIS 922uz. Once communication has been re-established, the file transfer can be tried again or the old application file used until the source of the data transfer problem can be found. Also, QSCcontrol.net WILL NOT communicate with the BASIS 922uz if it is in "safe mode". You may communicate only using TFTP, Telnet, or RS-232.

RS-232 Serial Port I/O Interface

The RS-232 connector on the rear panel is used as a serial port input/output (I/O). This I/O port is used for accessing Ethernet/IP settings, stand alone control capabilities, system "health" data, firmware version information and other related data.

Should any system problems arise, the data that may be accessed through this interface can help to track down the problem. The most common items that might be used are "Display Network Settings" and "Enter Network Setup". Many of the remaining selections would typically be used for troubleshooting purposes along with a QSC technical representative prompting you to access particular menu items so the data can be interpreted.

Connection is made using a normal serial cable between your computer's serial port and the RS-232 port of the BASIS 922uz. Once properly connected, a "dumb-terminal" program (such as *Hyper Terminal*, a widely used version on most Windows-based PC's) is started and communication established between the PC and the BASIS 922uz.

Following is the basic procedure for starting up *Hyper Terminal*, naming the connection, specifying the communications settings and an example of "what you should see" for a text-menu once the communications link has been established. If programs other than *Hyper Terminal* are used, you will need to follow your software's instructions for establishing communications through your PC's COM (serial) port.

Utility/Diagnostic Functions (continued)

RS-232 Communications Procedure:

- 1) Connect the **RS-232** port of the BASIS 922uz to an unused serial port (COM port) of a PC using a normal (straight-through) serial cable.
- 2) Open the HyperTerminal program. This program is usually started by clicking the Windows START icon, highlighting PROGRAMS, then ACCESSORIES, COMMUNICATIONS, and finally, highlighting the *Hyper Terminal* folder and clicking on its icon.
- 3) After starting *Hyper Terminal*, a *Connection Description* window will pop-up. It will require that you name your connection. Enter a name for your new connection (example: *BASIS 922uz*) and click *OK* to continue.
- 4) Next, *Hyper Terminal* needs to know how to “talk” to the BASIS 922uz. This selection depends on which port on your PC the cable is connected to. Ignore the first three entry fields (phone number information) and go directly to the “*Connect using:*” entry field and click on the down arrow for the drop-down menu selection. Select the port the BASIS 922uz is connected to and click *OK* to continue. The *Properties* window should appear next.
- 5) The *Properties* window for the selected *COM* port should now be active.

For the Port Settings, use the following information so communication between the BASIS 922uz and the computer is in the same “language”.

Bits per Second: 9600
Data Bits: 8
Parity: none
Stop Bits: 1
Flow Control: Xon/Xoff

Once you have set the properties as outlined, click *OK* to continue.

If all the connections and communications settings are correct, the main *Hyper Terminal* window will open.

- 6) The *Hyper Terminal* main window will appear next, but blank. Type the letter “h” (for help) and then the “Enter” key. This will prompt the BASIS 922uz to post its menu text. The “h” key is the Help prompt for the BASIS 922uz. A text menu will appear. This is sent by the BASIS 922uz and will detail your options and instructions for changing the address information.

From this main-menu you will need to make your menu choices and follow the instructions in the following sub-menus or screens. Although many of the instructions and tests may not pertain to a specific setup or troubleshooting situation, you may be asked to run certain tests by a QSC technical representative. The results of these tests will help to troubleshoot any problems.

The most common user item that might require settings to be changed would be the IP address information. This would be useful if the IP address was inadvertently changed to an unrecognized address and subsequently you were unable to “talk” to the BASIS 922uz over the network. This situation would require the “Display Network Settings” and “Enter Network Setup” items to be accessed for re-assigning a valid IP address.

IP ADDRESS ASSIGNMENT- ONLY REQUIRED FOR ATTACHING TO EXISTING NETWORKS! DO NOT CHANGE THE COMMUNICATIONS SETTINGS OF THE BASIS 922uz UNLESS CERTAIN OF YOUR ACTIONS. THE FACTORY-PROGRAMMED IP ADDRESS CAN BE ACCESSED USING THE FRONT PANEL DISPLAY MENU SYSTEM. RECORD THIS IP ADDRESS SHOULD YOU NEED TO RETURN TO THE INITIAL SETTINGS.

Utility/Diagnostic Functions (continued)

Telnet Access

The RS-232 features can also be accessed via Telnet. The Microsoft Telnet application is a Windows program. Consult Windows documentation for Telnet information.

Basic procedure for opening a Telnet session:

- 1-** To open the Telnet session- Click START, select RUN, type "Telnet" followed by a space, then the IP address of the BASIS 922uz you want to communicate with in the text box and click OK.
- 2-** If the address entered was correct and network communications with the BASIS 922uz are successful, the Telnet session should open.
- 3-** Now you have the same options that are available in the Serial Port I/O (RS-232) interface section.

Preliminary Specification

	IN	OUT	THRU
Dynamic Range (AES-17, -60dB Method, all sensitivities)			
unweighted	>110dB	>112dB	>108dB
A weighted	>113dB	>115dB	>111dB
Distortion (20Hz-20 KHz, all sensitivities)			
Gain= 0 - 30dB	<0.008% THD+N	<0.009% THD+N	<0.008% THD+N
Gain >30dB	<0.05% THD+N	<0.009% THD+N	<0.05% THD+N
Crosstalk (20Hz - 20KHz)			
inter-channel (max)	>75dB		
inter-channel (typ)	>90dB		
intra-channel (max)	>85dB		
intra-channel (typ)	>100dB		
Frequency Response			
20Hz - 20KHz (max)	± 0.5dB		
20Hz - 20KHz (typ)	± 0.2dB		
Program Inputs			
	8		
Connector Type	3-pin "Phoenix Style" (a.k.a. "Euro Style") detachable terminal blocks		
Type	Electrically balanced		
Grounding	All shield terminals connected to chassis		
Pinout	1:+ 2:- 3:CHASSIS GND		
Input Impedance (nom.)	Balanced: 6.81k ohms Unbalanced: 13.6k ohms		
Common-Mode Rejection	20Hz - 20KHz (min.): >54dB, 20Hz - 20KHz (typ.): >60dB		
E.I.N.(max.), unweighted	150 ohm, 30dB: -124.5dBu 150 ohm, 60dB: -125.0 dBu		
Input Sensitivities (variable)	Vrms: 0.9 mV to 15.46 V dBu: -62.2 to +26dBu dBV: -64.4 to +23.7 dBV		
Phantom Power (per IEC 1938 (1996))	+48V (software-selectable)		
Program Outputs			
	8		
Connector Type	4 HD-15 dataport connections		
Cable Type	QSC DataPort cable, QSC p-n DPC-x ("x" designates cable length in feet)		
Available "stock" Lengths	1, 2, 3, 4, 5, 6, 10, and 20 ft., custom lengths available.		
Maximum Qualified Length	328 ft. (100 m) QSC DataPort cable only. Non-QSC cable, 6 ft (2 m) max.		
Audio Converters			
	24 bit, 48KHz, in and out		
Mute			
	infinite attenuation		
Delay			
	Standard CobraNet Latency	Low Latency	
BASIS to Network			
Analog input through full DSP chain to CobraNet output	7.104 milliseconds	4.438 milliseconds	
Network to BASIS			
CobraNet input through full DSP chain to analog output	6.313 milliseconds	3.646 milliseconds	
BASIS to BASIS			
Analog input through full DSP chain, over CobraNet network, through full DSP chain, to analog outputs	8.083 milliseconds	5.417 milliseconds	
BASIS in stand-alone mode			
Analog input through full DSP chain to analog outputs	2.354 milliseconds (Default Group Delay)		
Control Room Foldback Monitoring			
Connector Type	5-pin "Phoenix Style" (a.k.a. "Euro Style") detachable terminal blocks		
Pinout	1:-(input) 2:-(input) 3:CHASSIS GND 4:-(output) 5:+(output)		
Tap points	8 internal input, 8 internal output, 8 amplifier (pre-, post-, amplifier) software-selectable		

Specifications are subject to change without notice

Preliminary Specification

Monitor Input

Monitor Signal (unit off)	Unity gain connection, relay bypass
Maximum level	+21 dBu
Impedance (nominal)	10K ohms
CMRR, 20Hz-20KHz	>54 dB

Monitor Output

Monitor	Sum of Monitor Input and signal from internal monitor tap point(s)
Freq. Resp. 20Hz-20KHz	+/- 0.5dB
Distortion (20Hz-20KHz)	<0.05% @ +4dBu
Noise Floor	>90dB
Output Impedance (nom)	100 Ohms
Output Load (min)	600 Ohms

Monitor Level

Control Range (nom)	0dB to -95.5dB in 0.5dB steps
---------------------	-------------------------------

Relay Outputs

Connector Type	2 discrete floating relay switch outputs
Configuration	3-pin "Phoenix Style" (a.k.a. "Euro Style") detachable terminal blocks
Pinout	Electromechanical Relay
Switching Capacity (nom)	1:NC 2:NO 3: COM
	1A 30VDC

Logic Outputs

Connector Type	4 discrete outputs
Configuration	2-pin "Phoenix Style" (a.k.a. "Euro Style") detachable terminal blocks
Pinout	Single-ended, TTL compatible
	1:+(Signal) 2:-(CHASSIS GND)

Omni Inputs

Connector Type	6 discrete inputs for TTL logic, voltage control or passive resistive
Configuration	2-pin "Phoenix Style" (a.k.a. "Euro Style") detachable terminal blocks
Pinout	Single-ended, ground referenced
Normal Operating Range	1:+(Signal) 2:-(CHASSIS GND)
Potentiometer Operation	Reads signals between 0-5V nominally
Voltage Tolerance	Use 10K for full range
Current Output	+/- 48V
	0.5mA with 10K pot (for passive resistive controls)

RS-232 Port

Female DB9 Connector

QSCControl.net

Neutrik Ethercon RJ45 Ruggedized Data Connector

CobraNet

Neutrik Ethercon RJ45 Ruggedized Data Connector

Indicators

QSCControl Status	Yellow Link, Tx, Rx, front panel / Green Link, Tx, Rx, rear panel
CobraNet Status	Yellow Link, TX, RX, front and rear panel
Power	Blue, front panel
Diagnostic	Red, front panel
DataPort Status (Port)	Tri-state (red, green, yellow), front panel
LCD Data Display	2 line x 16 character, backlit, front panel
Signal Presence	Tri-state (red, green, yellow), front panel

Dimensions

18.89" (479.8mm) W x 1.73" (43.9mm) H x 15.00" (381.1mm) D

Weight

10.24 lb. (4.64 kg)

Specifications are subject to change without notice.

Dimensions

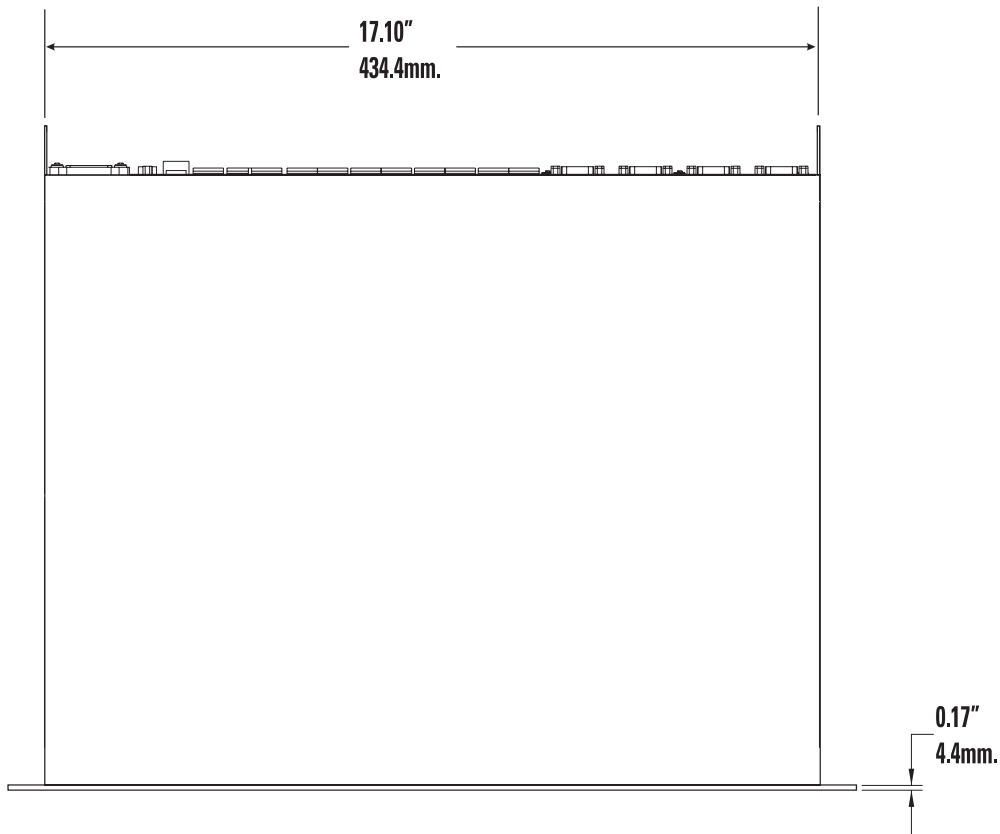
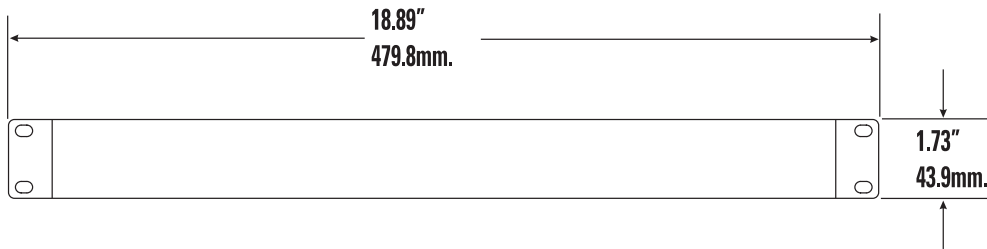
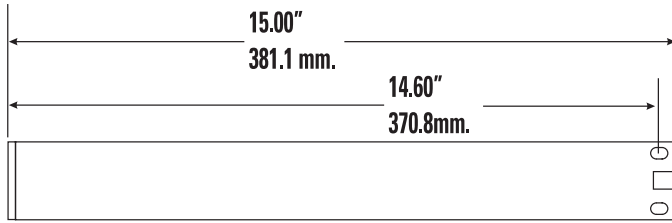

How to Contact QSC Audio Products

Mailing address: QSC Audio Products, Inc.
1675 MacArthur Boulevard
Costa Mesa, CA 92626-1468 USA

Telephone Numbers:

Main Number	(714) 754-6175
Sales & Marketing	(714) 957-7100 or toll free (USA only) (800) 854-4079
Customer Service	(714) 957-7150 or toll free (USA only) (800) 772-2834

Facsimile Numbers:

Sales & Marketing FAX	(714) 754-6174
Customer Service FAX	(714) 754-6173

World Wide Web: www.qscaudio.com

E-mail: info@qscaudio.com
service@qscaudio.com

Warranty Disclaimer (USA only; other countries, see your dealer or distributor)

QSC Audio Products, Inc. is not liable for any damage to amplifiers, loudspeakers, or any other equipment that is caused by negligence or improper installation and/or use of this signal processing product. While QSC has endeavored to develop and produce the most dependable and robust 'network' audio product for your use, due to the myriad of network situations and equipment that may be encountered in its implementation, QSC cannot be held responsible for network conflicts and associated consequences that may result. For this reason, QSC strongly recommends that the network used for implementation of QSCControl products be completely separate from all other networks, data or otherwise. As such, should you elect to integrate QSCControl products with your existing network system, all risks attendant to such integration of QSCControl products with your existing network or network systems are assumed by you. While QSC strives to provide the highest quality technical solutions for networked audio products, in no event will QSC or its suppliers be held liable for any damages, consequential, incidental or otherwise, including any claims for lost profits and/or savings resulting from any attempted integration of QSCControl products with your networking systems. No agent, employee or representative of QSC has any authority to alter or modify in any manner, the disclosures and recommendations set forth herein.

QSC Audio Products 3 Year Limited Warranty

QSC Audio Products, Inc. ("QSC") guarantees its products to be free from defective material and / or workmanship for a period of three (3) years from date of sale, and will replace defective parts and repair malfunctioning products under this warranty when the defect occurs under normal installation and use - provided the unit is returned to our factory or one of our authorized service stations via pre-paid transportation with a copy of proof of purchase (i.e., sales receipt). This warranty provides that the examination of the return product must indicate, in our judgment, a manufacturing defect. This warranty does not extend to any product which has been subjected to misuse, neglect, accident, improper installation, or where the date code has been removed or defaced. QSC shall not be liable for incidental and/or consequential damages. This warranty gives you specific legal rights. This limited warranty is freely transferable during the term of the warranty period.

Customer may have additional rights, which vary from state to state.

In the event that this product was manufactured for export and sale outside of the United States or its territories, then this limited warranty shall not apply. Removal of the serial number on this product, or purchase of this product from an unauthorized dealer, will void this limited warranty.

Periodically, this warranty is updated. To obtain the most recent version of QSC's warranty statement, please visit www.qscaudio.com.

Contact us at 800-854-4079 or visit our website at www.qscaudio.com.



QSC Audio Products, Inc. 1675 MacArthur Boulevard Costa Mesa, California 92626 USA
©2005 "QSC" and the QSC logo are registered with the U.S. Patent and Trademark Office.