

ALLEN & HEATH



XONE:DB2

USER GUIDE

Publication AP8640

Limited One Year Manufacturers Warranty

This product is warranted to be free from defects in materials or workmanship for period of one year from the date of purchase by the original owner.

To ensure a high level of performance and reliability for which this equipment has been designed and manufactured, read this User Guide before operating.

In the event of a failure, notify and return the defective unit to the place of purchase.

If this is not possible then please contact the authorised ALLEN & HEATH distributor or agent in your country as soon as possible for repair under warranty subject to the following conditions.

Conditions of Warranty

The equipment has been installed and operated in accordance with the instructions in this User Guide.

The equipment has not been subject to misuse either intended or accidental, neglect, or alteration other than as described in the User Guide or Service Manual, or approved by ALLEN & HEATH.

Any necessary adjustment, alteration or repair has been carried out by an authorised ALLEN & HEATH distributor or agent.

This warranty does not cover fader wear and tear.

The defective unit is to be returned carriage prepaid to the place of purchase, an authorised ALLEN & HEATH distributor or agent with proof of purchase.

Please discuss this with the distributor or the agent before shipping.

If the unit is to be repaired in a different country to that of its purchase the repair may take longer than normal, whilst the warranty is confirmed and parts are sourced.

Units returned should be packed to avoid transit damage.

In certain territories the terms may vary. Check with your ALLEN & HEATH distributor or agent for any additional warranty which may apply.

If further assistance is required please contact Allen & Heath Ltd.

IMPORTANT- PLEASE READ CAREFULLY:

By using this Allen & Heath product and the software within it, you agree to be bound by the terms of the relevant End User Licence Agreement (EULA), a copy of which can be found on the Allen & Heath website in the product's pages. You agree to be bound by the terms of the EULA by installing, copying, or otherwise using the software.

This product complies with the European Electromagnetic Compatibility directive 2004/108/EC and the European Low Voltage Directive 2006/95/EC.

This product has been tested to EN55103 Parts 1 & 2 1996 for use in Environments E1, E2, E3, and E4 to demonstrate compliance with the protection requirements in the European EMC directive 2004/108/EC. During some tests the specified performance figures of the product were affected. This is considered permissible and the product has been passed as acceptable for its intended use. Allen & Heath has a strict policy of ensuring all products are tested to the latest safety and EMC standards. Customers requiring more information about EMC and safety issues can contact Allen & Heath.

NOTE: Any changes or modifications to the console not approved by Allen & Heath could void the compliance of the console and therefore the users authority to operate it.

XONE:DB2 User Guide AP8640

Copyright © 2011 Allen & Heath Limited. All rights reserved

Allen & Heath Limited

Kernick Industrial Estate, Penryn, Cornwall, TR10 9LU, UK

<http://www.allen-heath.com> <http://www.XONE.co.uk>

PACKED ITEMS

Check that you have received the following:

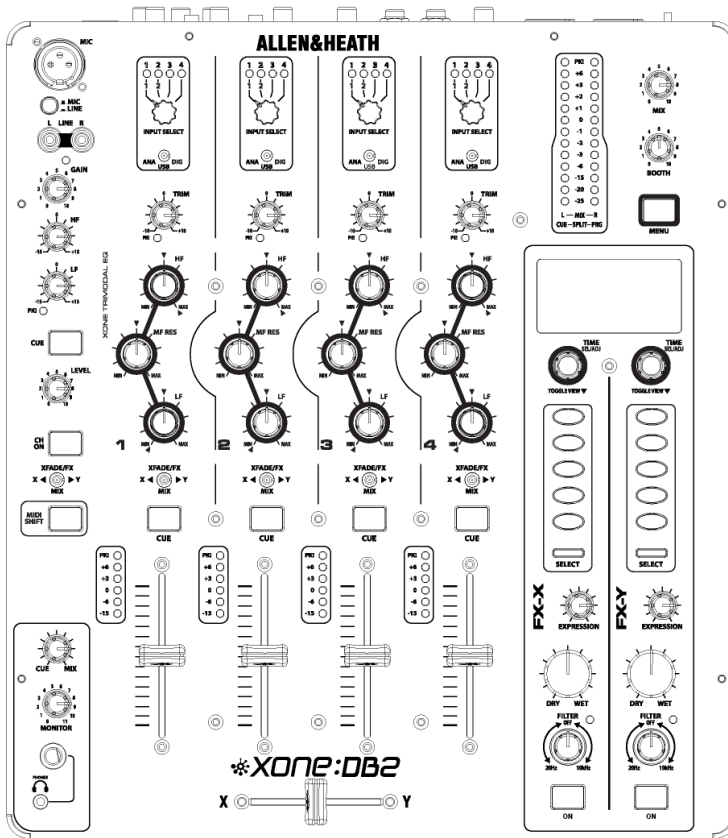

XONE:DB2 mixer.

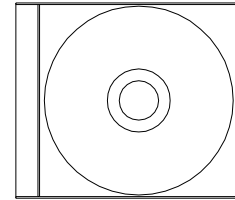

XONE:DB2 resource CD-ROM.

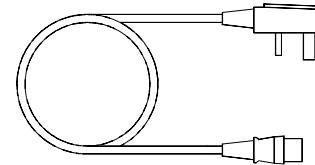

Mains Lead

Check that the correct mains plug is fitted.

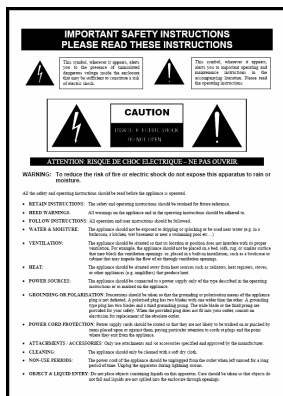

Safety Sheet.

Important ! Read this sheet before starting.

Retain for future reference.

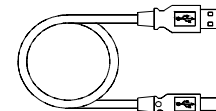

Type A-B USB Lead.

To connect the XONE:DB2 to your computer.

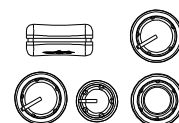

Spare knobs.

PANEL DRAWINGS

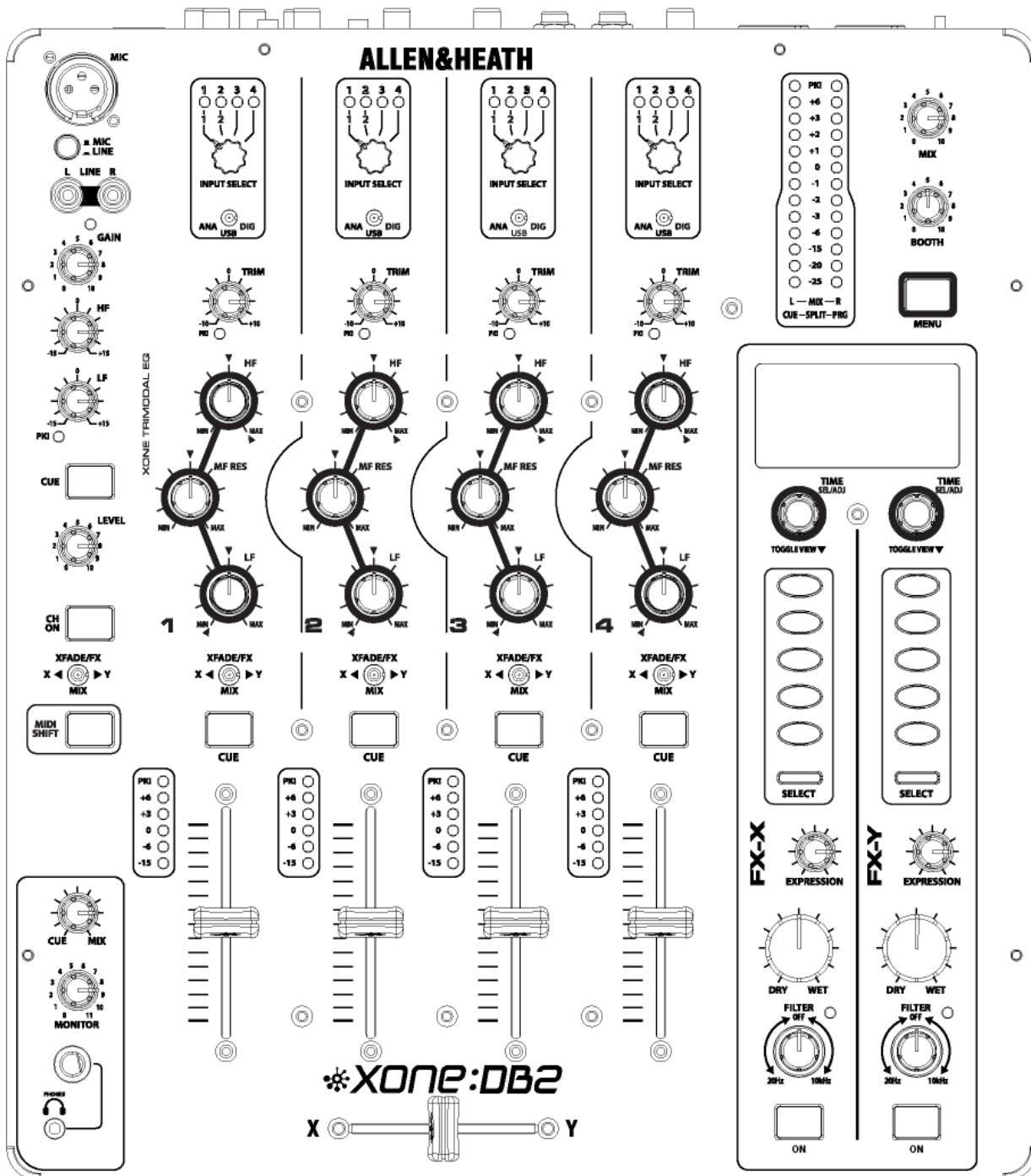
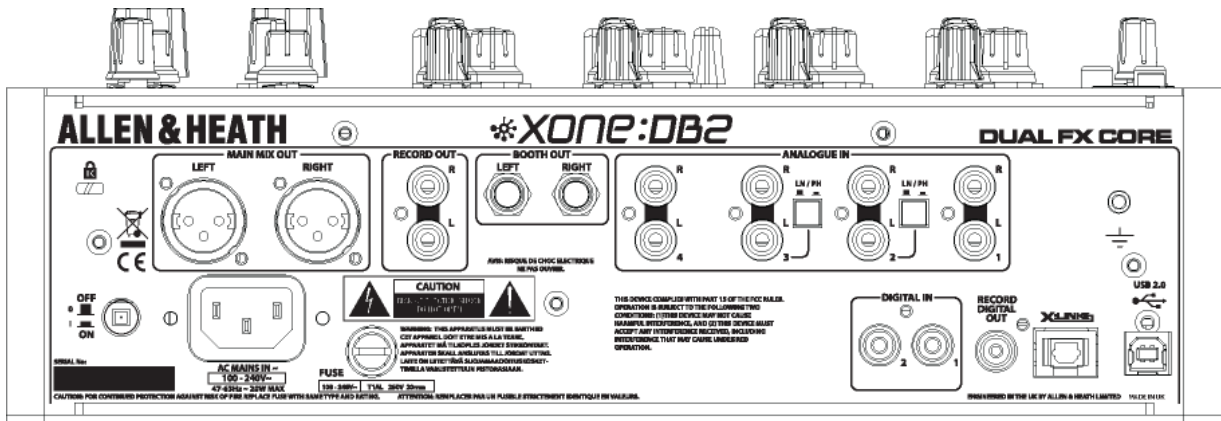

APPLICATION DIAGRAM

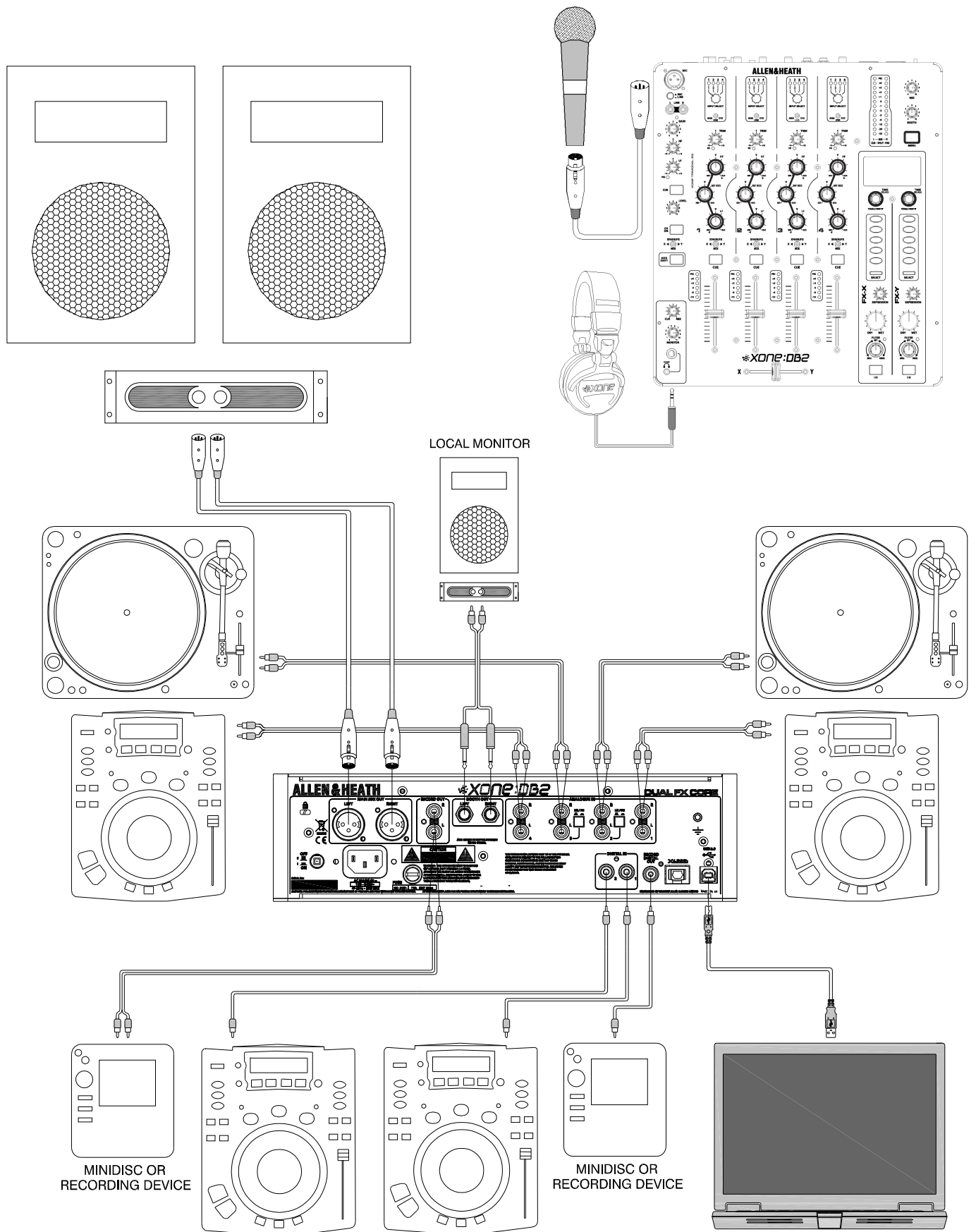

INTRODUCTION TO THE XONE:DB2

Congratulations on the purchase of your new XONE:DB2

The XONE:DB2 is a ground-breaking mixer featuring studio quality effects and performance features that blur the boundary between DJ'ing and live production. Every feature has been meticulously researched with a view to providing you, the DJ, with the ultimate creative tool.

The DB2's dual FX core is based on the Allen & Heath iLive pro-touring console, but with FX algorithms further developed for BPM conscious parameters and tight spectral control. Many of the FX are new and unique to the DB2, and have been specifically designed to perfectly fit the DJ environment.

With the flexible input matrix, any audio source can be selected on any or all of the channels; this allows for different processing to be applied to the same track on separate channels.

The XONE:DB2 is more than a mixer with an effects unit; many parameters of each effect can be altered and, along with the built in library of effects, this means that the scope for audio manipulation is almost unlimited, allowing you to develop a totally unique sound in your mixes. It is also perfectly at home in your production studio, where it can be used as a stereo multi-channel effects processor, digitally inserted into your chosen DAW, using the flexible routing options available on the built in 16 channel USB2.0 soundcard.

The XONE:DB2 is designed to be intuitive and easy to use. However, it is worth spending time reading this manual to ensure you get the maximum from it.

We have had a lot of fun designing the DB2, and we are sure you will have even more fun using it.

Best wishes

The XONE:DB2 design team

CONTENTS

To ensure that you get the maximum benefit from your XONE:DB2 please spare a few minutes familiarising yourself with the controls and setup procedures outlined in this user guide. For further information please refer to the additional content available on our web site, or contact our technical support team.

<http://www.XONE.co.uk>

Warranty.....	2
Packed Items	3
Panel Drawings	4
Application Diagram.....	5
Introduction to the DB2.....	6
Mic/Line Channel.....	8
Music Channels	10
Master Section.....	11
The Input Matrix	12
Xone Trimodal EQ	13
The FX Section.....	14
Loading alternative FX	15
The FX Display	16
BPM Engines	17
Setup Menu EQ and XFader	18
Advanced Setup Menu	19
USB Audio System.....	23
PC Driver Installation.....	26
Mac Driver Installation.....	29
MIDI Control	32
MIDI Control Messages	33
Digital In/Out and X-Link.....	35
Specifications.....	36
Notes.....	37
Registration Card.....	38

MIC / LINE CHANNEL

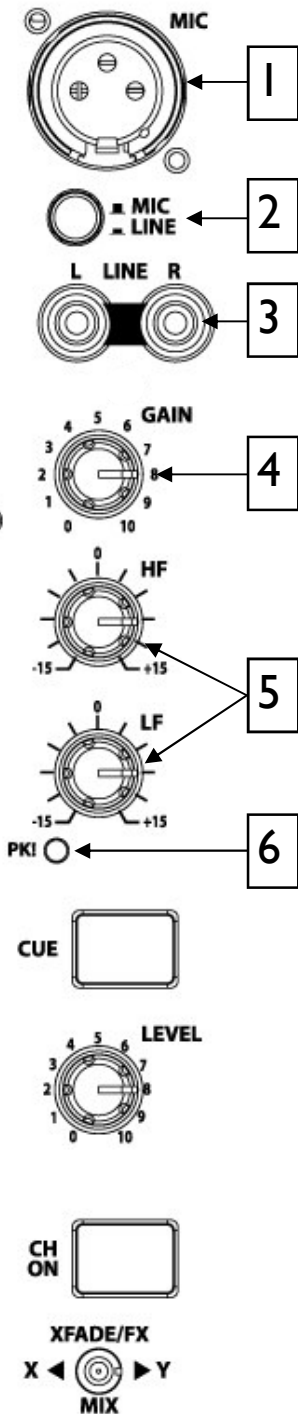

1

MICROPHONE INPUT CONNECTOR

Balanced XLR. Plug in a DJ, guest or announcement microphone here. Use a good quality low impedance dynamic mic such as those specifically designed for vocals. Do not use high impedance or unbalanced microphones, or condenser types which require phantom power.

Use the best professional grade balanced cables and connectors you can afford, as these are typically subject to intense use and abuse in the club environment.

2

MIC / LINE SELECTOR SWITCH

Selects the channel source between MONO Microphone and STEREO Line input connectors

3

LINE INPUT CONNECTOR

Dual RCA sockets for connecting an external line level source.

4

GAIN CONTROL

Sets the level of the source signal to the channel.

5

MIC EQ Controls

The MIC equaliser provides a tool to adjust the tonal quality of the sound to correct source problems such as microphone response, proximity effect, noise and feedback, to help the voice cut through the mix, or to adjust the overall 'feel'. Start with the EQ controls set to their mid (flat) position, then adjust to achieve the desired sound.

6

CHANNEL PEAK LED

Illuminates if the channel signal is within 3dB of clipping.

MIC / LINE CHANNEL

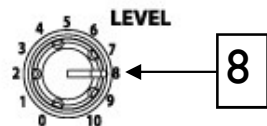
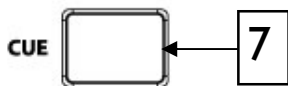
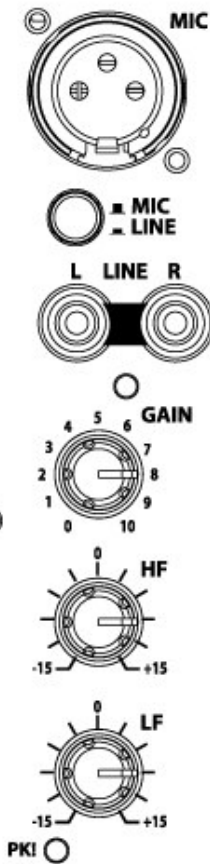

7

CHANEL CUE SWITCH

Press the Cue switch to listen to the channel pre-fade signal in the headphones and view its level on the main meters. The backlit switch lights red when selected. Press the switch again to deselect cue.

8

CHANNEL LEVEL CONTROL

Sets the level of the channel signal in the main mix.

9

CHANNEL ON SWITCH

Turns the channel On or Off. This feature is useful if a microphone is being used to switch it in and out of the mix.

10

XFADE / FX SWITCH

Selects where the channel output will be routed:

MIX (Centre) - Routes the signal directly to the mix

X - Routes the signal to the input of FX-X or to X xfader

Y - Routes the signal to the input of FX-Y or to Y xfader

MUSIC CHANNEL

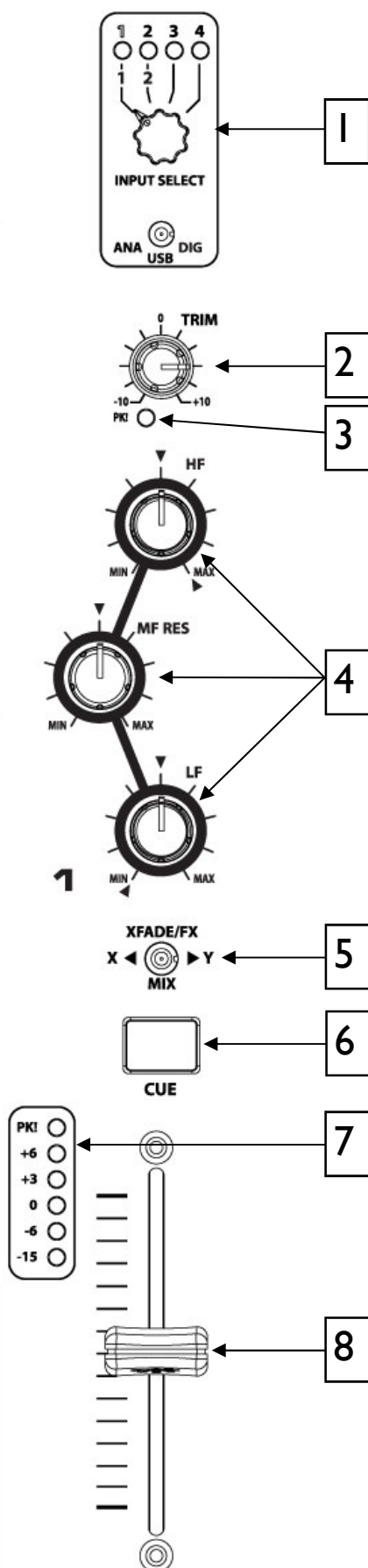

1

MATRIX INPUT SELECTOR

Please refer to Page 12 for further information on how to use this feature.

2

INPUT TRIM

Amplifies or attenuates the input signal by up to ± 10 dB.

3

INPUT PEAK LED

Illuminates if input signal is within 3dB of clipping. If this happens lower the Trim level.

4

EQ SECTION

Configured as either Three band EQ or High-Pass/Low-Pass filter depending on menu setting. Please refer to Page 13 for further details on this feature.

5

XFADE / FX ASSIGN

Selects where the channel output will be routed:

MIX (Centre) - Routes the signal directly to the mix

X - Routes the signal to the input of FX-X and to Xfader X

Y - Routes the signal to the input of FX-Y and to Xfader Y

6

CHANNEL CUE SWITCH

Press the cue switch to listen to the channel pre-fade signal in the headphones and see its level on the main meters. The button will illuminate when selected.

The channel cue can operate in several modes. For more information please refer to "HP Setup" on page 20.

7

CHANNEL METER

Displays the channel signal level. It is post-EQ and pre-fader.

The channel level control should be set so that the channel meter averages around '0', with loudest peaks no higher than '+6'. Turn down the Trim control if the **PK!** indicator lights.

8

CHANNEL FADER

A high quality, smooth travel fader adjusts the channel signal level from fully off to fully on.

MASTER SECTION

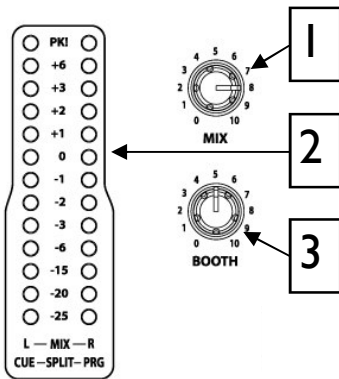

1 MIX MASTER LEVEL CONTROL

A rotary master control adjusts the level of the main mix XLR outputs feeding the house sound system. This does not affect the monitor output or the meter reading.

2 MIX / MONITOR METERS

The main meters follow the selected monitor source. The meter reads '0' for an XLR output of +4dBu. The mixer should be operated with these meters averaging around '0' with loudest peaks no higher than '+6'.

In SPLIT CUE mode, whilst a channel cue button is pressed, the left meter will display the CUE level and the right meter will display the PROGRAM (PRG) level. For more about CUE modes please see "HP Setup" on Page 20.

3 BOOTH MASTER LEVEL CONTROL

Adjusts the level of the signal to the stereo monitor RCA output. This does not affect the headphones. The monitor output could be used for a booth monitor, recording or an additional zone feed.

4 CUE / ADD MIX CONTROL

Pans between Cue signal and the Main Mix output. Turned fully anti-clockwise, only the active Cue signal is heard through the headphones when a Cue is selected. Gradually turning clockwise introduces the Main Mix output to the Cue signal until, fully clockwise, only the Mix is heard. This does not affect the meters. Split Mode pans Left (Cue) to Right (Mix), see Page 20.

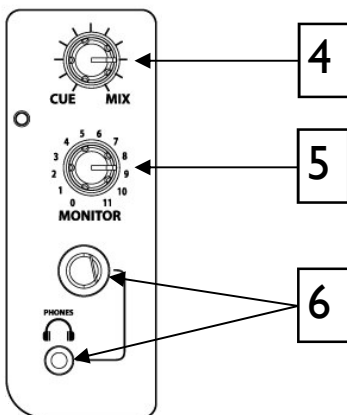

5 MONITOR LEVEL CONTROL

Adjusts the level of the headphone signal. The headphone level can be further trimmed up or down in level in the Advanced Setup Menu: see Page 20.

6 HEADPHONES OUTPUTS

Stereo 1/4" TRS jack and 3.5mm mini-jack. Plug in good quality stereo headphones intended for DJ monitoring. Use closed-ear headphones that provide maximum acoustic isolation when cueing your sources. We recommend that you use high quality headphones rated between 30 to 100 ohms impedance. 8 ohm headphones are not recommended as their very low impedance may cause damage to the headphone amplifier.



Warning ! To avoid damage to your hearing do not operate the headphones or sound system at excessively high volume. Continued exposure to high volume sound can cause frequency selective or wide range hearing loss.

THE INPUT MATRIX

Each music channel on the XONE:DB2 features an input matrix system, making it possible to select from any of the ten available sources no matter which input socket they are physically connected to.

Each channel can accept inputs in three formats:

ANALOGUE

Channel 1 - Line only

Channel 2 - Line or Phono (Selector switch on rear panel)

Channel 3 - Line or Phono (Selector switch on rear panel)

Channel 4 - Line only

USB

Channel 1 - ASIO Soundcard Output 1-2

Channel 2 - ASIO Soundcard Output 3-4

Channel 3 - ASIO Soundcard Output 5-6

Channel 4 - ASIO Soundcard Output 7-8

DIGITAL

S/PDIF Input 1 and 2 via RCA on rear panel.

Example Usage

Using the matrix, a CD player plugged into Analogue Input 4 of your mixer can be routed to Channel 1 by setting the Toggle Switch to 'ANA' and the Input Select Rotary to '4', or can be assigned to all four channels simultaneously by repeating the process on all input channels.

Alternatively, if you wish to select your source to be DAW Soundcard Outputs 5-6, set the Toggle Switch to 'USB' and the Input Select Rotary to '3'.

NOTE: When "DIG" is selected, only the first two LEDs will light. Rotating the input select rotary past 2 will leave 2 selected and have no other effect.

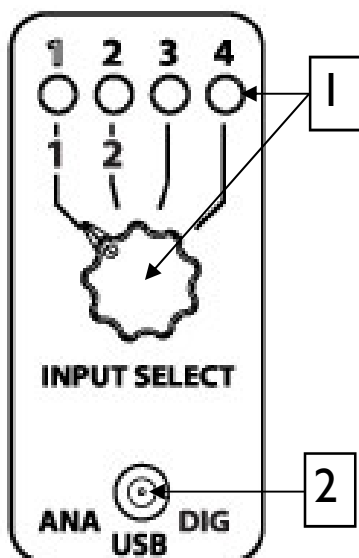

INPUT SELECTION

Turn the 4-position rotary switch to select one of the four available input sources.

The green LED will illuminate to show which is the currently selected source.

INPUT SOURCE SELECT SWITCH

Toggle switch allowing selection between Analogue (ANA), USB and DIGITAL (DIG) sources.

XONE TRIMODAL EQ

The Trimodal EQ on the XONE:DB2 can operate in any one of three different modes:

ISOLATOR MODE

In this mode, the EQ provides full attenuation when fully anti-clockwise and a safe +6dB of boost when fully clockwise. This EQ offers a steep 24dB/octave slope for tight frequency isolation.

EQ MODE

In this mode, the EQ provides -26dB of attenuation and +6dB of boost. This EQ has a gentler 12dB/octave slope better suited to certain styles of music.

FILTER MODE

In FILTER MODE, the EQ section becomes a high and low pass filter system with adjustable resonance, offering precise control over the frequency spectrum. The filters have a 12dB/octave slope. The MF pot controls the resonance, or “sharpness” (Q) of the filter.

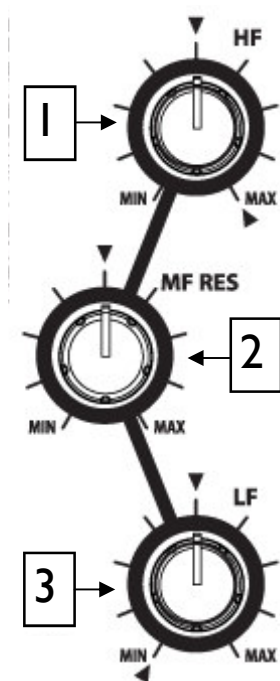

1 HF CONTROL

Adjusts the high frequency content of the channel audio. In **ISO** or **EQ** mode the centre-detent position will give a flat frequency response, fully clockwise will boost the high frequencies by 6dB, and anticlockwise will attenuate them.

In **FILTER** mode this control becomes a low-pass filter, and must be rotated fully clockwise for a flat frequency response. Rotating anticlockwise will progressively lower the cut-off frequency of the filter.

2 MF/RES CONTROL

Adjusts the mid range frequency content of the channel audio. In **ISO** or **EQ** mode the centre-detent position will give a flat frequency response, fully clockwise will boost the mid frequencies by 6dB, and anticlockwise will attenuate them.

In **FILTER** mode this control sets the sharpness (Q) or resonance of the two filters. Rotate fully anticlockwise for low resonance, and fully clockwise for high resonance. Use this control with care as a high resonance will boost the signal level at the Filter cut-off point which could cause the signal to clip.

3 LF CONTROL

Adjusts the low frequency content of the channel audio. In **ISO** or **EQ** mode the centre-detent position will give a flat frequency response, fully clockwise will boost the low frequencies by 6dB, and anticlockwise will attenuate them.

In **FILTER** mode this control becomes a high-pass filter, and must be rotated fully anticlockwise for a flat frequency response. Rotating clockwise will progressively raise the cut-off frequency of the filter.

SWITCHING EQ MODES

The Trimodal EQ is switched globally and is described in further detail on Page 18

THE FX SECTION

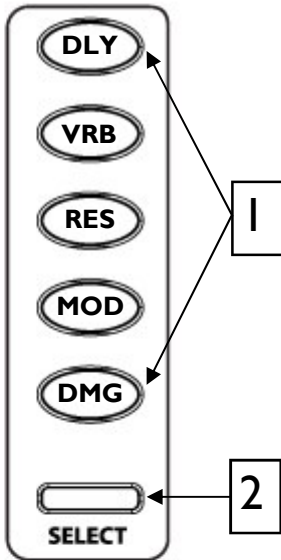

The intuitive layout of the XONE:DB2 FX section enables easy selection of any one of the five different effect types:

(DLY) DELAY

(VRB) REVERB

(RES) RESONATOR

(MOD) MODULATOR

(DMG) DAMAGE

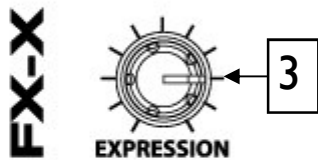

The WET/DRY control [4] sets the level from no effect (DRY) when fully anticlockwise to maximum effect (WET) when fully clockwise. The EXPRESSION [3] controls a further parameter; for instance, regeneration when DELAY is selected.

All time related effects are automatically synchronised to the music by the BPM detection system which operates independently for each of the two FX engines.

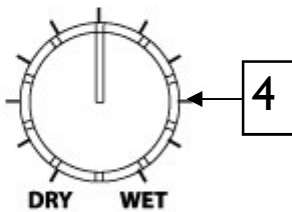

FX Operation

Pressing any of the five effects buttons [1] will select that effect. Each time an effect button is pressed it will illuminate green. Only one effect per channel can be selected.

When an effect is selected further parameters can be adjusted using the global control encoders above the effect type switches; see Page 16 for details.

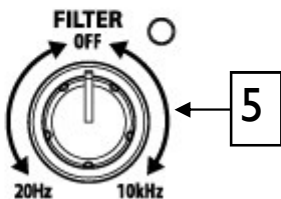

Each basic effect type, DLY, VRB, RES, MOD, and DMG has a library of alternative effects within the same category. These are accessed using the SELECT button [2]. Press the SELECT button to open up the effect library list on the display screen. See page 15 for details.

To turn ON the selected effect, press the relevant FX ON switch [6]. This switch has two modes of operation, latching and momentary. To latch the switch ON, tap once. To briefly switch ON an effect, press and hold the button; the effect will turn off on release. This function also works the other way, so if an effect is ON, pressing and holding the button will turn the effect off until the button is released.

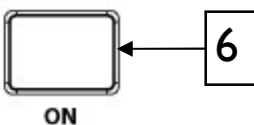

The effect can also be filtered using the FILTER control [5]. Rotating the filter clockwise will operate a high pass filter, and rotating anticlockwise will operate a low pass filter. The LED above the control will illuminate green if it is in its centre position (i.e. filter off) or red if in the high pass or low pass region, giving a visual indication that the filter is engaged. The effect of the filter will only be heard if the FX ON switch [6] is illuminated.

The filter can be used independently of the effect by setting the wet/dry control [4] to dry (fully anticlockwise).

LOADING IN ALTERNATIVE EFFECTS PRESETS

Loading Alternative Effects from the Internal Library

Each basic effect type, DLY, VRB, RES, MOD and DMG has a library of alternative presets within the same category. These are accessed using the SELECT button. To view or load a preset, press an FX button, then press the SELECT button - this will display the selected effect library. Use the SEL/ADJ encoder next to the display screen to scroll through the list, then press the encoder to load the chosen preset. Check our website, www.XONE.co.uk/db2 for in-depth information on the effects types and their use.

Press one of the FX types you want to load the new preset into.

Press the **SELECT** Button to open the selected effect library.

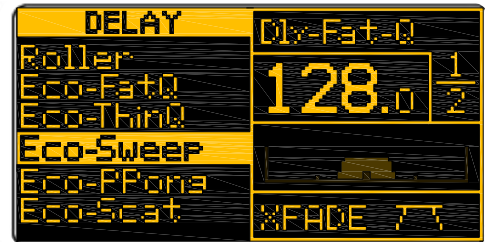
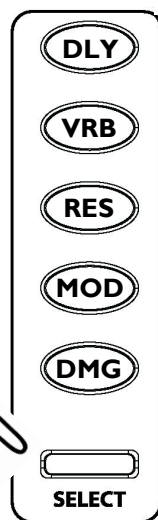

Use the **SEL/ADJ** encoder to scroll up or down through the effect library list. Press the encoder to load the chosen effect. The Library list will automatically close and you will be returned to the main mixer screen with the new effect showing in the display.



The effect list illustrated may differ depending on the firmware version running on your XONE:DB2

THE FX DISPLAY WINDOW

The effects display screen is divided horizontally into two segments labelled **FX-X** and **FX-Y**.

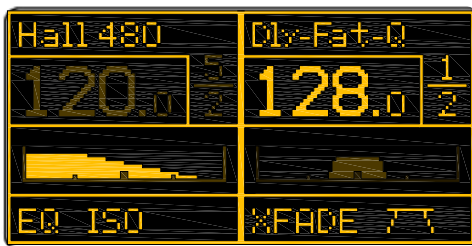
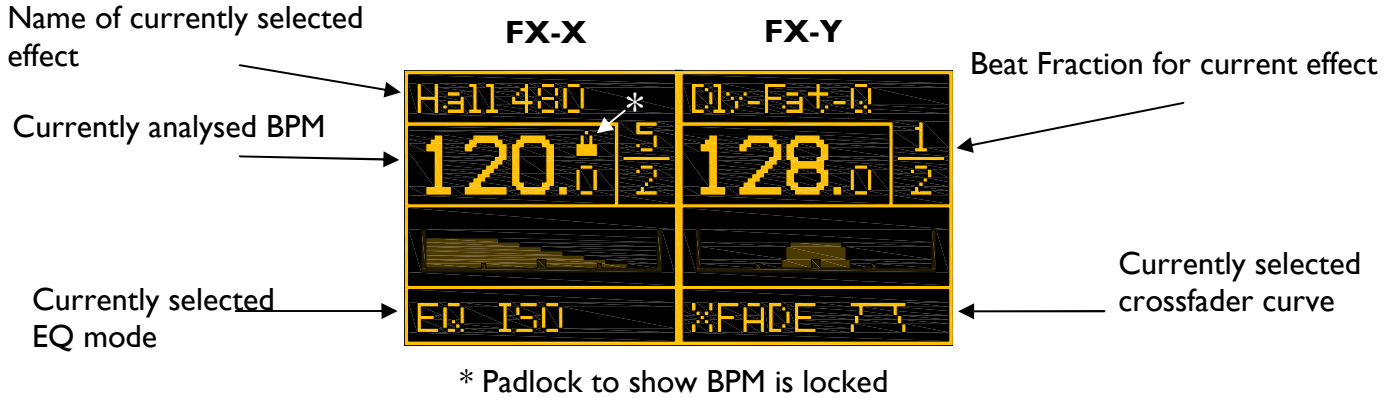

BPM FOCUS: When the BPM display is in highlighted, this encoder sets the beat fraction for each effect. Rotating anticlockwise will decrease the time, and rotating clockwise will increase it. The time defaults to fractions of the detected BPM.

mS DISPLAY: The BPM display can be changed to milliSeconds by holding down the DLY button and pressing the encoder.



THIRD PARAMETER FOCUS: When the third parameter is highlighted, this encoder adjusts the third effect parameter (e.g. the filter of a Delay).

▼ TOGGLE VIEW

Pressing this encoder will toggle the focus between the BPM or the third parameter of the effect.

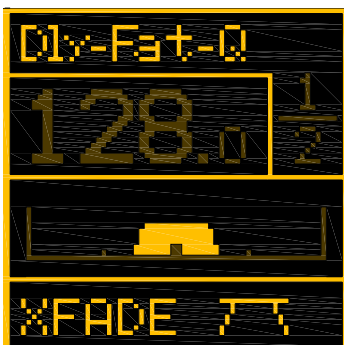

In this view, the third parameter of the Delay effect “Fat-Q” is highlighted. It represents a frequency graph, with the low frequencies on the left, high on the right. The shaded area shows the frequency band of the output filter of the delay.

Rotating the encoder control will move the centre frequency of this filter, and the shaded area will move left or right.

BPM ENGINES

The XONE:DB2 has two independent BPM detection engines, one per FX unit. Tempo analysis is complex, what might seem an obvious beat to a human requires sophisticated algorithms for a micro-processor to interpret.

Unlike a DAW (digital audio workstation) the DB2 doesn't have the complete song file to analyse, it has to do it real time by "listening" to the audio. To improve the speed and accuracy of tempo analyses the beat detection engines can be guided to look for a tempo within a given range. This is selected in the setup menu, under "BPM RANGE".

The range options are shown below; choose one that nearest matches the style of music you normally play. If you tend to play songs with a wide variety of different tempos, set the detection system to 60 to 240, but be prepared for the occasional misreading, usually a direct harmonic of the real tempo, especially where there is syncopation.

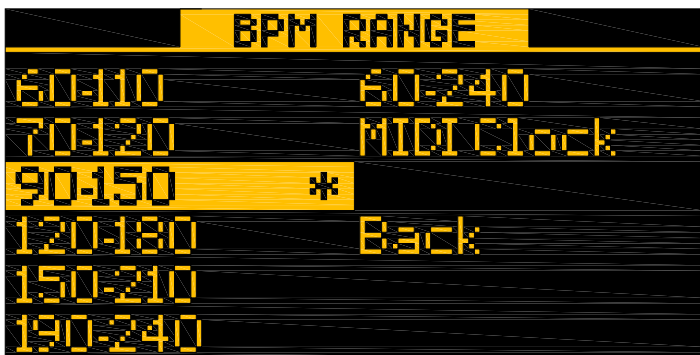

EXTERNAL MIDI CLOCK

If your playback source is a DAW running through the built-in USB2.0 multi-channel soundcard, you can use MIDI clock as the timing source for the DB2, this will override normal BPM detection and affects all channels. If you select this mode make sure that your DAW supports sending MIDI clocks, and that this feature is enabled.

TEMPO RESET

The BPM detection system can be forced into a reset by holding down the FX TIME encoder until the tempo display changes to "- - -.". The BPM is automatically reset when a new audio source is selected, or the range changed in the menu.

TEMPO LOCK

Current Tempo can be locked at any time by pressing and holding the FX TIME encoder until the padlock symbol comes up in the display. When a tempo is locked it will not change when switching to an alternative audio source.

SETUP MENU - EQ AND CROSSFADER



The front page of the setup menu displays the setup options for the EQ and crossfader.

To enter the setup menu; press the MENU button, then use the 'SEL/ADJ' encoder to scroll up or down between 'EQ SETUP' and 'XFADER SETUP'.

To return to the front screen, select EXIT, or press the MENU button again.

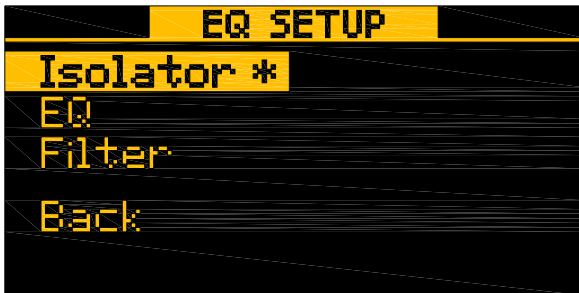

The mode of the EQ can be set to **Isolator**, **EQ** or **Filter** using the EQ Setup menu. This is a global setup and so applies to the EQ controls on all channels.

For more information on the Trimodal EQ system please refer to Page 13.

Select Back to return to the top Menu screen.

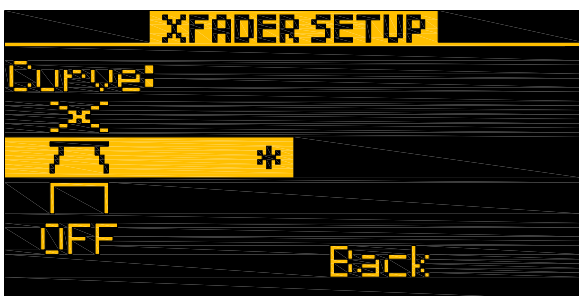

The crossfader setup sets the response of the crossfader curve between dipped, dipless and fast-cut, better suited to scratching.

It is also possible to turn the crossfader off from this screen. If the crossfader is set to 'Off', the MENU LED will illuminate if the crossfader is moved.

ADVANCED SETUP MENU

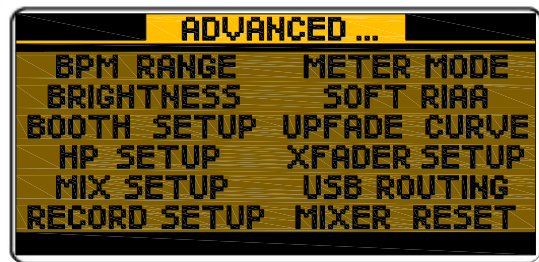

The advanced setup menu lists various settings that can be altered, enabling you to fine tune the DB2 to better suit your application. Use the 'SEL/ADJ' encoder to select 'ADVANCED' in the front MENU screen.

The options are as listed.

BPM RANGE

Selects the most appropriate tempo range for the style of music you play. You can also select external MIDI clock as the synchronisation source.

BRIGHTNESS

Allows you to adjust the brightness of the front panel LEDs to suit the ambient lighting conditions.

BOOTH SETUP



Trim: Sets the signal level of the Booth outputs. 0.0dB corresponds to a nominal output level of +4dBu when the main meters read 0vU. This is an ideal level to feed power amplifiers or interface with pro audio equipment. If the Booth level is too high, it can be attenuated by up to 40dB.

Phase: Allows you to reverse the signal Phase of the Booth output. The DB2 is phase coherent, i.e. the signal phase of the output is the same as the input, however in some installations acoustic reflections can create a phase cancellation between the booth monitors and the main PA. This often results in loss of bass frequencies, so try reversing the Booth phase to see if it improves the fidelity of the system.

Source: There are three options available, Mix, Cleanfeed, or Phones. Mix will send the same signal to the record out as to the main mixer outputs, Cleanfeed will send the Mix output less the signal from the Mic channel, and Phones will send the headphone monitor signal.

ADVANCED SETUP MENU

HP SETUP

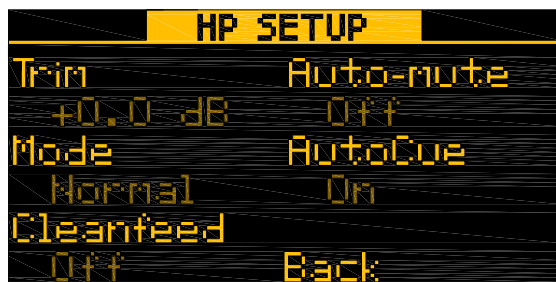

This menu enables you to set the sensitivity, audio source and mode of the headphone cue system

Trim: Adjusts the operating level of the headphone amplifier to match the sensitivity of your headphones. The trim ranges from -28 to $+12$ dB.

Mode: Toggles between *Split* and *Normal*. In *Split* mode a mono sum of the main mix is sent to the right headphone and the cue signal in the left. Use the CUE/MIX control to pan between the two. The main meters will display cue level on the left and mix level on the right.

Normal mode will provide a stereo cue or main mix signal to the headphone output, dependant of the position of the CUE/MIX control. The meters will display a stereo signal level of the main mix, or the channel pre-fade signal level when a Cue is activated.

Cleanfeed: Selects whether or not the signal from the Microphone input is routed to the headphones when the CUE/MIX control is set to Mix; for instance, if you don't want to hear the MC's microphone when beat-matching to the main mix set this to On. The options are On/Off.

Auto-mute: If this is set to On, the headphone output will be muted until a channel Cue is activated. If set to Off, the headphone output will default to the main mix or clean feed when all channels cues are off.

AutoCue: Selects whether or not the selected cue will auto-cancel any other selected cue. If set to On, cancellation will occur, if set to Off you will need to manually cancel any other selected cue.

MIX SETUP



Trim: Sets the signal level of the Main Mix outputs. 0.0dB corresponds to a nominal output level of +4dBu when the main meters read 0vU. This is an ideal level to feed power amplifiers or interface with pro audio equipment. If the Mix level is too high, it can be attenuated by up to 40dB.

Phase: Allows you to reverse the individual left/right signal Phase of the Main Mix outputs. This control can also be used as a temporary fix for wrongly wired balanced cables or speaker systems. Normal means that the mixer is Phase coherent, i.e. the output signal is the same phase as the input.

ADVANCED SETUP MENU

RECORD SETUP

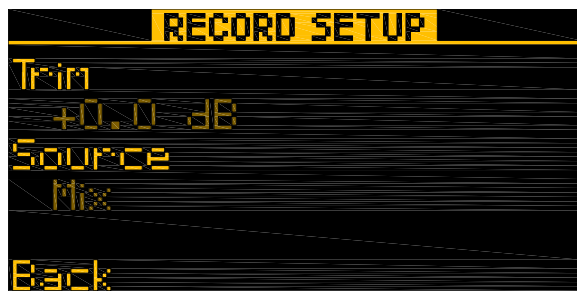

Trim: Sets the signal level of the analogue record outputs **and** the Digital Output. 0.0dB corresponds to a nominal output level of +4dBu when the main meters read 0VU. This is an ideal level to feed power amplifiers or interface with pro audio equipment, but is too high for most recording devices, (minidiscs etc) so use this control to attenuate the output level by up to 40dB.

Source: There are three options available; Mix, Cleanfeed, or Phones. Mix will send the same signal to the record out as to the main mixer outputs, Cleanfeed will send the Mix output less the signal from the Mic channel, and Phones will send the headphone monitor signal. The Digital output will also be affected by any routing changes made here.

METER MODE

BAR—Peak reading VU display

DOT—Single dot display showing peak level.

PEAK—As BAR, but the highest signal level LED will remain lit for a short period to provide a clearer

SOFT RIAA

When set to On, a software RIAA preamp is applied to the selected channel (1 or 4). This will give sufficient gain and equalisation to play vinyl straight into these channels. As this is a software gain system, the channel may exhibit a slightly higher noise floor if compared directly to the channels with a hardware preamp (channels 2 and 3). This raised noise floor will not be noticeable once the vinyl is playing.

When set to Off, normal line level signal can be played through the channels.

UPFADE CURVE

The curve of the channel faders can be set to **Sharp**, **Mid** and **Gentle**. Choose a setting that best suits the style of music you play.

XFADER SETUP

The xfader can be set to be either **PRE** or **POST** FX. For instance if a channel is routed to a Delay effect:

- if set to **PRE**, and if the channel is crossfaded out, the effect 'tail' will decay into the mix.
- if set to **POST**, and if the channel is crossfaded out, the output of the effect unit will be cut along with the channel audio.

ADVANCED SETUP MENU

USB ROUTING

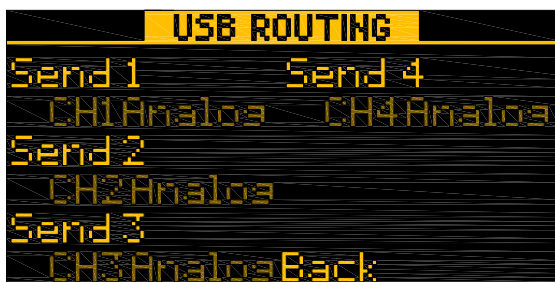

This menu selects the routing options for the upstream USB. Send 1 corresponds to USB 1-2, Send 2 to USB 3-4 etc. See page 24 for more information,

The options are:

- CHI-4 Analog:** Routes the selected converted analogue input to the soundcard input.
- CHI-2 Digital:** Routes the selected digital input to the soundcard input.
- CHI-4 Post Fader:** Routes the selected pre-fade channel audio to the soundcard input.
- MIC Pre Lev:** Routes the pre level microphone signal to the soundcard input.
- MIC Out:** Routes the post level microphone signal to the soundcard input.
- Record:** Routes the record output to the soundcard input.
- Booth:** Routes the booth output to the soundcard input.
- Mix:** Routes the mix output to the soundcard input.
- Phones:** Routes the headphone (CUE) signal to the soundcard input.

To view the Soundcard Input Block Diagram, please see Page 24.

MIXER RESET

Will force a hard reset of the mixer, returning all user options to the default factory setting.

ABOUT



The **ABOUT** screen displays the currently loaded Code Version and Boot Loader (BL) version.

Periodically, firmware updates may become available for Your DB2. Please check www.xone.co.uk/db2 regularly.

Updating Firmware

Check the Xone website for new firmware and, if available, follow the instructions to download it. When installing firmware please ensure that:

1. You close all audio and MIDI applications before commencing
2. Your DB2 is connected to the USB port you normally use
3. You do not power down the DB2 or disconnect the USB cable.

Please note: The firmware update can take anywhere between 3 and 5 minutes to complete.

USB AUDIO SYSTEM

The 16-channel USB2.0, 48kHz/24bit audio system built into the XONE:DB2 makes it the perfect interface for use with Digital Audio Workstation software. The mixer deals with the processor intensive effects work, leaving the computer lightly loaded to better stream the audio data. Another advantage is that all processing is kept in the digital domain, especially if the DAW is used to simultaneously record the mix. MIDI compatible DAWs can be controlled from the DB2 via MIDI.

The supplied low-latency drivers must be installed before connecting the XONE:DB2 to a computer; see page 26 for PC installation, or page 29 for Mac installation.

SOUNDCARD NOMENCLATURE

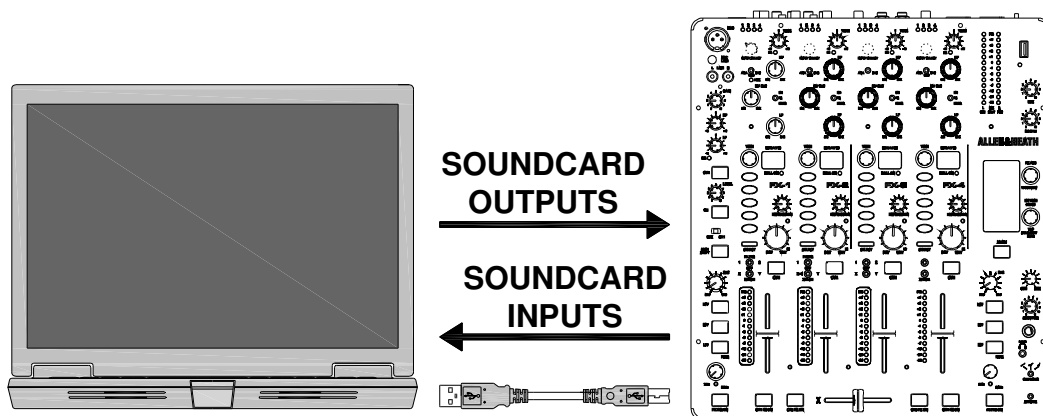

Referencing the above diagram, Soundcard Inputs are from the XONE:DB2 to the PC/MAC and Soundcard Outputs are from the PC/MAC to the XONE:DB2.

SOUNDCARD OUTPUTS

The XONE:DB2 has eight (four stereo) soundcard outputs that will appear in your chosen DAW application. The outputs are arranged as follows:

DAW	XONE:DB2
SOUNDCARD OUTPUT 1-2	USB 1
SOUNDCARD OUTPUT 3-4	USB 2
SOUNDCARD OUTPUT 5-6	USB 3
SOUNDCARD OUTPUT 7-8	USB 4

SELECTING A USB AUDIO CHANNEL

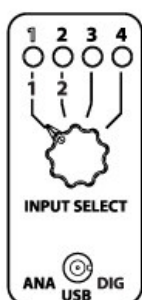

To select USB audio on one of the XONE:DB2 input channels, set the source switch to USB and then use the Input Select switch to choose which USB channel you wish to use.

USB SOUND CARD ROUTING

SOUNDCARD INPUTS

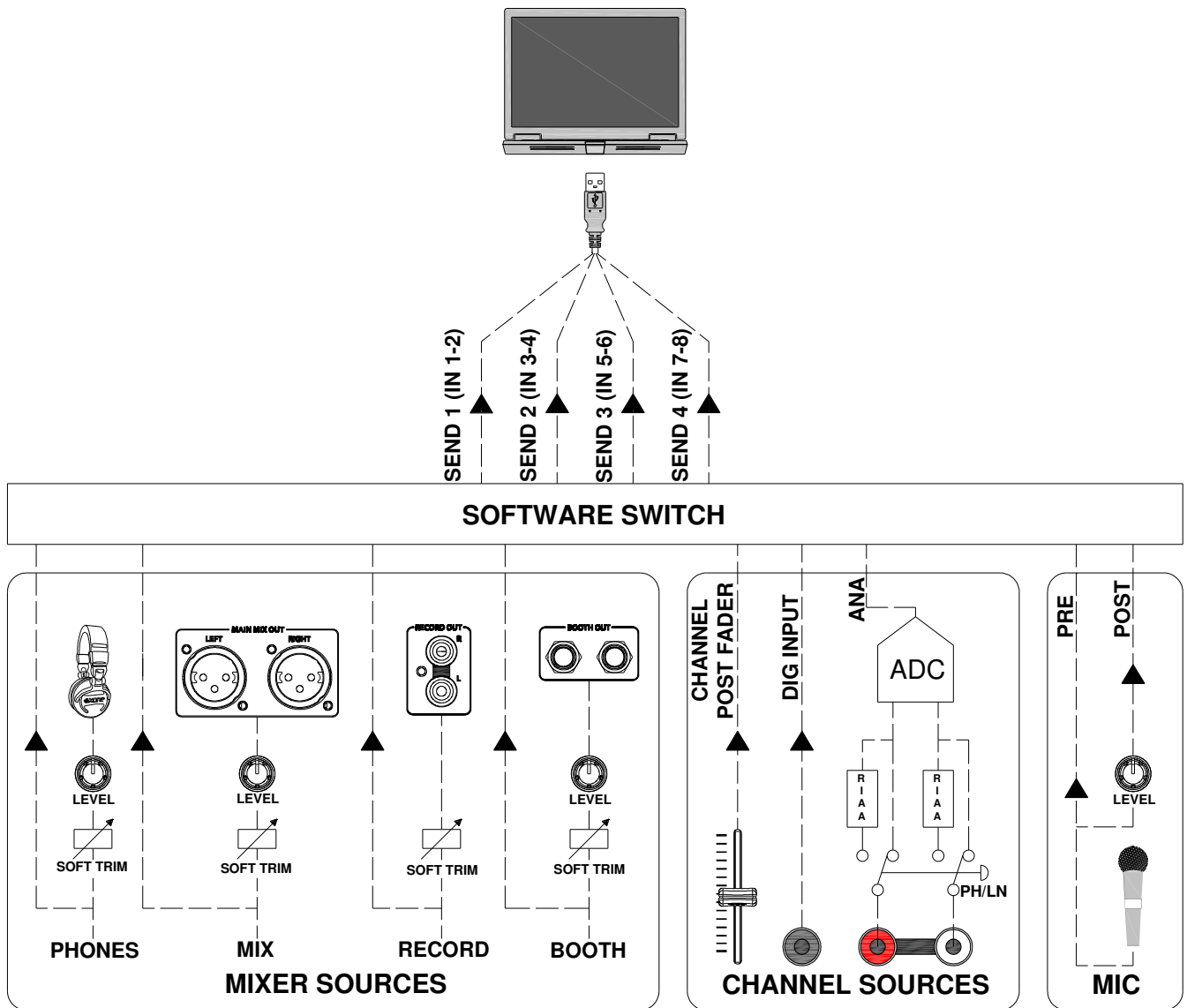

The XONE:DB2 provides eight (four stereo) soundcard inputs that will appear in your chosen DAW application. The inputs are arranged as follows:

DAW	XONE:DB2
SOUNDCARD INPUT 1-2	SEND 1
SOUNDCARD INPUT 3-4	SEND 2
SOUNDCARD INPUT 5-6	SEND 3
SOUNDCARD INPUT 7-8	SEND 4

The block diagram above shows the different sources that can be mapped to each of the stereo soundcard inputs (or Sends). The sources are split into three groups - MIXER, CHANNEL and MIC and are selected via the advanced setup menu see page 21.

USB SOUND CARD ROUTING

CHANNEL SOURCES

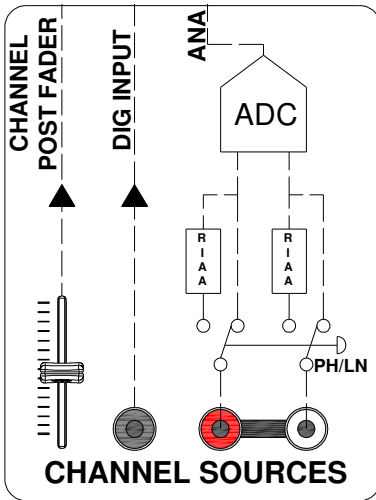

Each of the USB audio sends can source from various points within the XONE:DB2 Input Channels. From the diagram, the three options are Analogue In, Digital In and Channel PFL.

ANALOGUE IN - The analogue sources are arranged as follows:

CHANNELS 1 AND 4 - LINE INPUT ONLY
 CHANNELS 2 AND 3 - SWITCHABLE LINE /PHONO

DIGITAL IN - The source connected to digital input 1 or 2.

CHANNEL POST FADER - The signal from the channel that is sent to the mix.

MICROPHONE INPUT

Each USB send can also be mapped to the pre and post level microphone input.

MIXER SOURCES

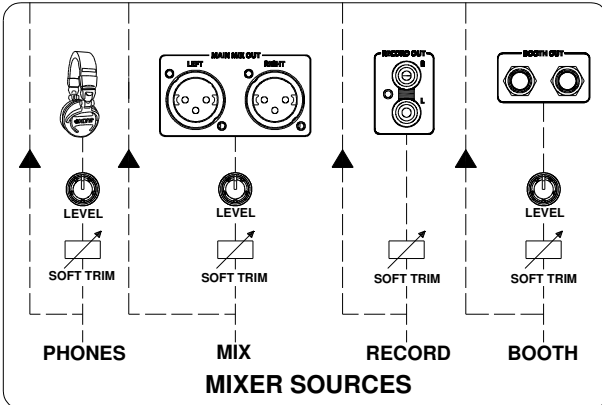

The USB audio sends can also source from any of the mixers outputs. From the diagram, the four options are the Booth Output, Record Output, Mix Output and Headphone (CUE bus) Output.

BOOTH OUTPUT - Routes the chosen send to the Booth Output. For more information on Booth Output source options, please refer to Page 19.

RECORD OUTPUT - Routes the chosen send to the Record Output. For more information on Record Output source options, please refer to Page 21.

MIX OUTPUT - Routes the chosen send to the Mix Output. For more information on Mix Output source options, please refer to Page 20.

PHONES OUTPUT - Routes the chosen send to the Phones Output. For more information on Phones Output source options, please refer to Page 20.

MAPPING A SOUND CARD INPUT SEND

For details on selecting Soundcard Input Send sources please see “USB Routing” on Page 22.

PC DRIVER INSTALLATION

STOP!

BEFORE YOU CONNECT YOUR XONE:DB2 TO A COMPUTER PLEASE FOLLOW THESE INSTRUCTIONS ON INSTALLING THE CORRECT DRIVERS FOR THE USB SOUNDCARD.

CHECK www.XONE.co.uk/db2 FOR NEWS ON THE LATEST DRIVER VERSIONS

Software Installation (Windows XP, Vista and Windows 7)

Follow the procedure described below to install the USB audio and MIDI drivers:

1— Connect the XONE:DB2 to your mains electricity supply and switch on.

Do not connect the DB2 to the PC at this time.

2— Open the Drivers folder and run **Setup.exe**.

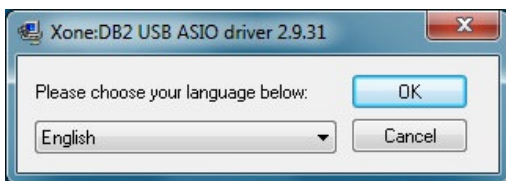

3— Select your preferred language

4— Select **Install the driver**

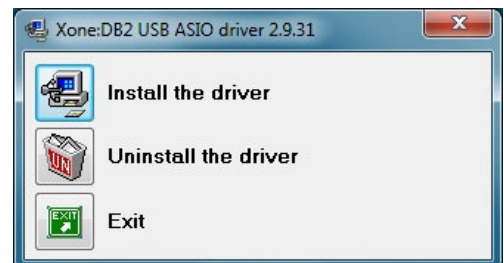

5— When prompted, connect the DB2 to the PC with the USB lead.

PC DRIVER INSTALLATION



6—If this window appears, select 'Install'.

7—The USB driver will now install.

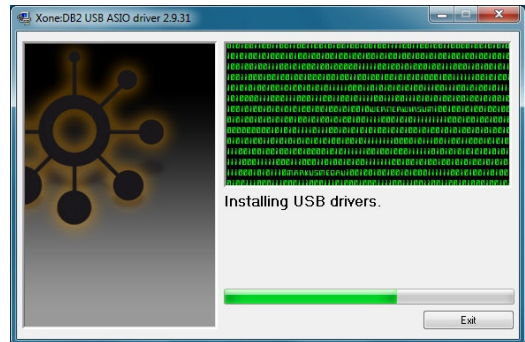

8— If this window appears, select 'Install'.

9— Reboot to complete installation.

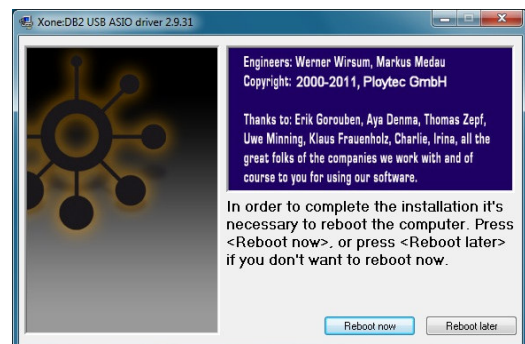

The installation process may differ slightly dependant upon Operating System and Security Software.

Note: Always use the same USB port with your XONE:DB2. When installing on a MS Windows system, the drivers will be associated with the USB port that you are currently plugged into. If you attempt to use the DB2 with another USB port, or without installing the drivers at all, the system may work but with degraded performance (XP, Vista, Windows 7), or may not work at all (2000).

PC DRIVER INSTALLATION

Checking the Driver Installation

Once the driver installation is complete, you will need to check that the XONE:DB2 is being recognised. Connect the XONE:DB2 to your PC/laptop and then right click on **My Computer** and select **Manage**. Next select **Device Manager** in the left hand window.

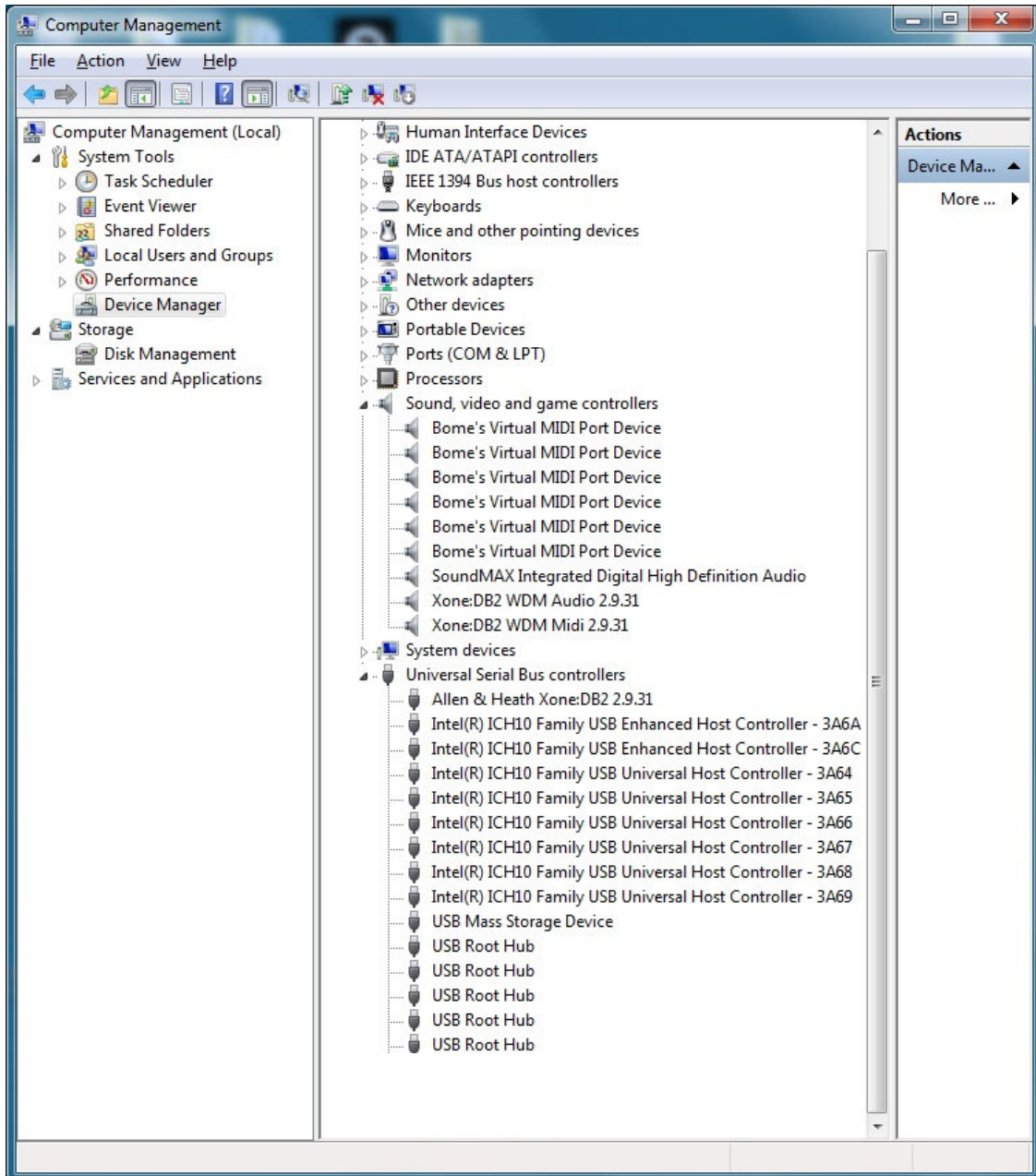

Expand the **Sound, Video and Game Controllers** section to reveal the WDM audio and MIDI drivers for the XONE:DB2.

Expand the **Universal Serial Bus Controllers** section to reveal the XONE:DB2 ASIO driver and its release (version) number—in this case V2.9.31.

MAC DRIVER INSTALLATION

STOP!

BEFORE YOU DO ANYTHING WITH YOUR XONE:DB2, PLEASE READ THE FOLLOWING CAREFULLY TO ENSURE YOUR MAC IS CORRECTLY SET UP TO BE USED WITH THE MIXER.

CHECK www.XONE.co.uk/db2 FOR NEWS ON THE LATEST DRIVER VERSIONS

Mac OSX

Open the XONE_DB2_Driver_x.x.x.dmg to reveal the window shown.

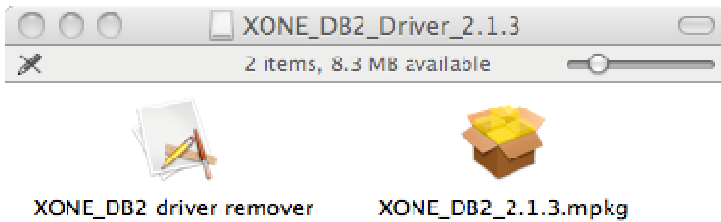

Click on the XONE:DB2 mpkg file to launch the driver installation.

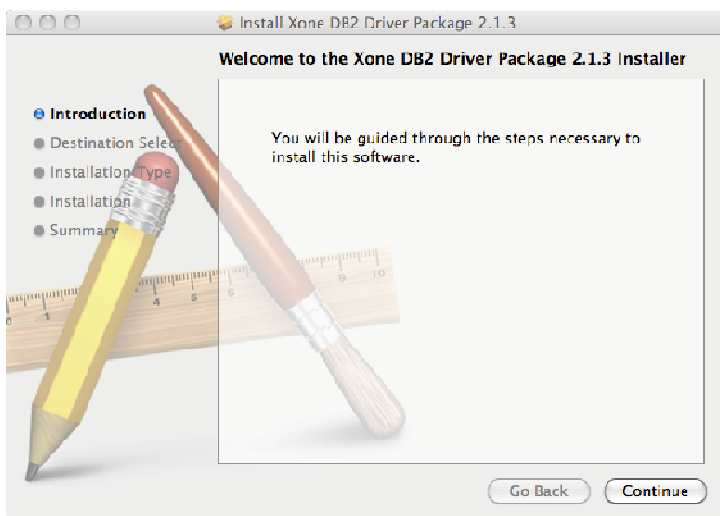

Click on "Continue".

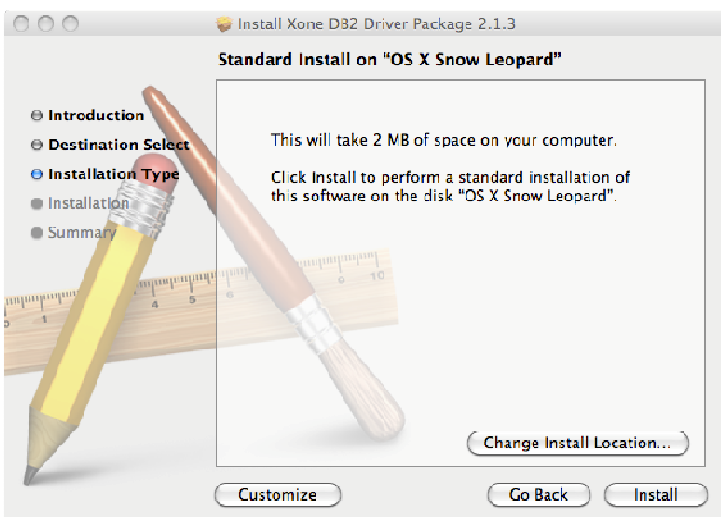

Select install location and then click "Install".

MAC DRIVER INSTALLATION



Enter your system password.

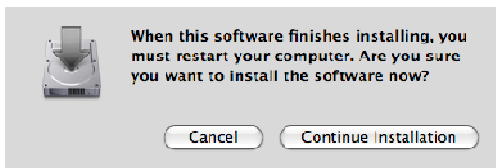

Click on "Continue Installation".

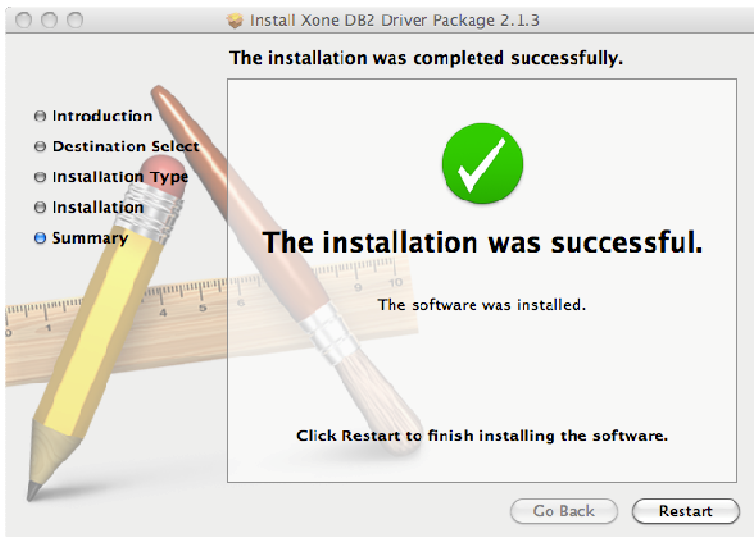

Restart your Mac.

MAC DRIVER INSTALLATION

Checking the Driver Installation

Once the driver installation is complete, you will need to check that the XONE:DB2 is being recognised. To do this, connect the XONE:DB2 to your Mac and then , from the file menu, select:

GO → Utilities → Audio MIDI Setup

The **Audio Devices** window will open automatically. To open the **MIDI Studio** window, from the File Menu, select:

Window → Show MIDI Window

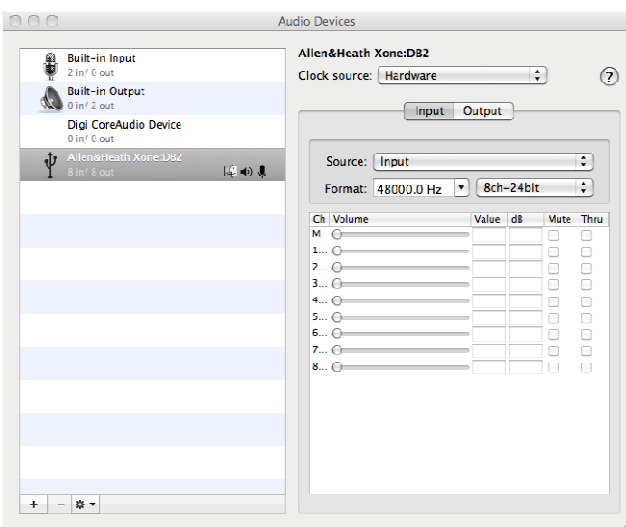

In the **Audio Input** section, the number of channels should be seen as 8, running at 48kHz, 24 bit.

In the **Audio Output** section, the number of channels should be seen as 8, running at 48kHz, 24 bit.



Now select the **MIDI Devices** tab and make sure that the XONE:DB2 is seen as a MIDI device as shown.

MIDI CONTROL

MIDI stands for Musical Instrument Digital Interface, and is an interface protocol from the nineteen eighties to enable different keyboards, sequencers, drum machines, etc. to communicate with each other.

MIDI is still a common interface used by most DAW software to allow remote control of various functions within the program.

Virtually all the front panel controls on the XONE:DB2 send MIDI data when operated, the only exception being the Mic/Line switch, Mic Gain and Headphone level as these are analogue controls.

All of the illuminated buttons on the DB2 can be activated remotely via MIDI.

MIDI SHIFT MODE

The DB2 has a useful feature to enable easy remote control of DAWs without affecting the mixer, this is called “MIDI SHIFT”. MIDI shift is activated by pressing the button above the screen, and is confirmed by the display panel changing to “MIDI SHIFT”.

When MIDI shift is active, the FX Type buttons, FX Select buttons and Global encoders are disconnected from the Mixer, and only send MIDI data when operated. This provides a total of 17 independent MIDI controls that can be mapped to software. The illuminated buttons can also be remotely turned off/on by the DAW if it has the capability of sending output messages.



Press to enter MIDI shift Mode



Pressing once will latch the button, for momentary function, press and hold.

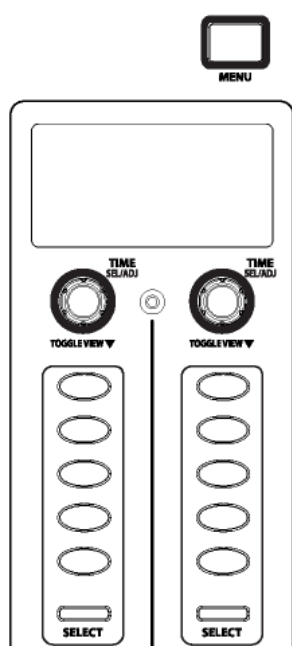

MIDI SHIFT MODE

These are the independent controls available when the MIDI SHIFT function is activated:

MIDI CONTROL MESSAGES

INPUT MATRIX

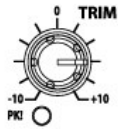
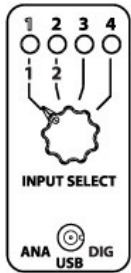

DB2 CHANNEL	INPUT SELECT				SOURCE			TRIM CONTROL
	1	2	3	4	ANA	USB	DIG	
1	Eb 6 CH 16	D 6 CH 16	C# 6 CH 16	C 6 CH 16	F 6 CH 16	OFF ◀▶	E 6 CH 16	CC 32 CH 16
2	G 4 CH 16	F# 4 CH 16	F 4 CH 16	E 4 CH 16	A 4 CH 16	OFF ◀▶	G# 4 CH 16	CC 6 CH 16
3	B 2 CH 16	Bb 2 CH 16	A 2 CH 16	G# 2 CH 16	C# 3 CH 16	OFF ◀▶	C 3 CH 16	CC 24 CH 16
4	Eb 1 CH 16	D 1 CH 16	C# 1 CH 16	C 1 CH 16	F 1 CH 16	OFF ◀▶	E 1 CH 16	CC 15 CH 16

EQ SECTION

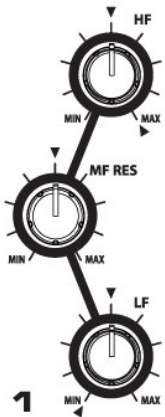

DB2 CHANNEL	EQ CONTROL		
	HF	MF	LF
1	CC 31 CH 16	CC 27 CH 16	CC 29 CH 16
2	CC 5 CH 16	CC 2 CH 16	CC 4 CH 16
3	CC 23 CH 16	CC 19 CH 16	CC 21 CH 16
4	CC 14 CH 16	CC 10 CH 16	CC 12 CH 16

CHANNEL FX AND XFADE ASSIGN, CUE AND FADER

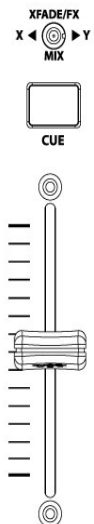

DB2 CHANNEL	FX / XFADE			CUE	FADER
	X	OFF	Y		
1	C# 5 CH 16	OFF ◀▶	D 5 CH 16	F 5 CH 16	CC 37 CH 16
2	F 3 CH 16	OFF ◀▶	F# 3 CH 16	A 3 CH 16	CC 35 CH 16
3	A 1 CH 16	OFF ◀▶	Bb 1 CH 16	C# 2 CH 16	CC 38 CH 16
4	C# 0 CH 16	OFF ◀▶	D 0 CH 16	F 0 CH 16	CC 36 CH 16

MIDI CONTROL MESSAGES

EXPRESSION, DRY / WET, FILTER AND FX ON SWITCH

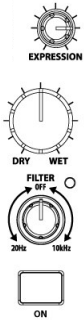

FX UNIT	EXP	DRY/ WET	FILTER	FX ON
X	CC 9 CH 16	CC33 CH 16	CC 34 CH 16	E 8 CH 16
Y	CC 11 CH 16	CC 7 CH 16	CC 3 CH 16	F 8 CH 16

ADDITIONAL CONTROLS

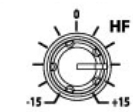

CC 26, CH 16

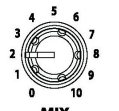

CC 18, CH 16

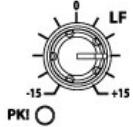

CC 28, CH 16

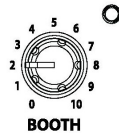

CC 20, CH 16



G# 6, CH 16



CC 22, CH 16



CC 30, CH 16



A 6, CH 16

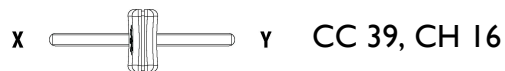

CC 39, CH 16



X - G# 8 CH 16
Y - A 8 CH 16

MIDI SHIFT MODE



TOGGLE VIEW ▼

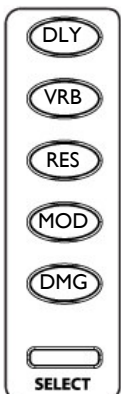

FX UNIT	ENC ROTARY	ENC SWITCH	DLY	VRB	RES	MOD	DMG	SELECT
X	CC 112 CH 16	F# 5 CH 16	G 5 CH 16	G# 5 CH 16	A 5 CH 16	Bb 5 CH 16	B 5 CH 16	C 5 CH 16
Y	CC 113 CH 16	Bb 3 CH 16	B 3 CH 16	C 4 CH 16	C# 4 CH 16	D 4 CH 16	Eb 4 CH 16	E 3 CH 16



B-1, CH 16

DIGITAL IO - X-LINK

DIGITAL INPUTS - DIGITAL OUTPUT

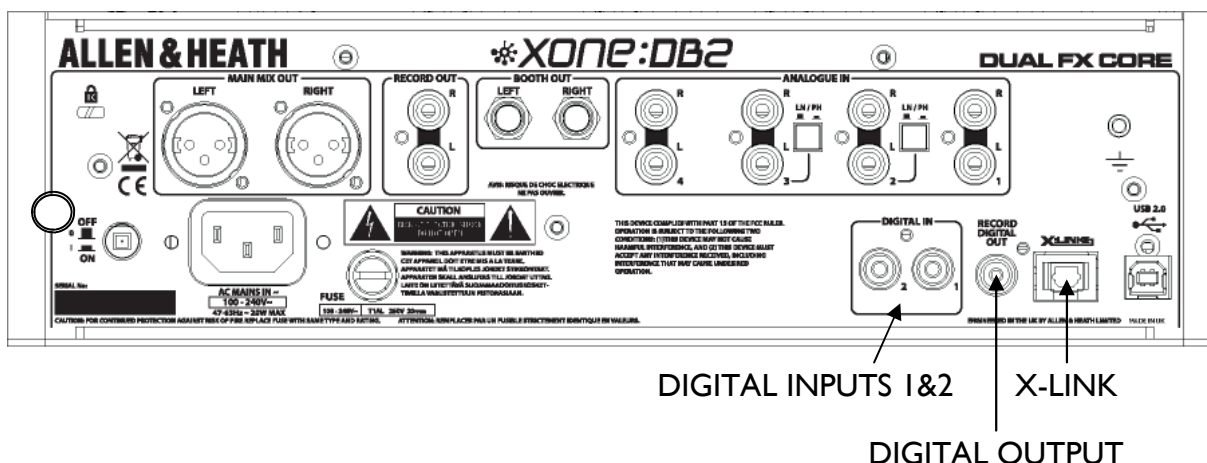

DIGITAL INPUT: The XONE:DB2 has two digital inputs on the rear panel designed for standard 75 Ohm RCA interface cables. These inputs are compatible with the following formats: AES3, IEC60958, S/PDIF (Sony/Phillips Digital Interconnect Format), EIAJ CP1201, all from 32kHz to 192kHz, and up to 24bits.

Digital Output: The digital output is fixed at 48kHz/24 bit, non copy protected, with a 75 Ohm impedance. The digital output source, and signal level is set in the Menu under “Record Setup”, see page 24 for details.

X-LINK

X-Link is a proprietary interface protocol to enable future Allen & Heath accessories and controllers to be easily connected to the XONE:DB2. Visit www.XONE.co.uk for the latest news on X-Link enabled products.

DIGITAL ARCHITECTURE SPECIFICATION

Analogue/Digital conversion	24 bit
Analogue/Digital Line-up	+12dBu = 0dBFS
DSP processing	24 bit I/O + 48 bit EQ
DSP Mix Bus	56 bit Fixed Point
DSP core sampling frequency	48kHz
USB soundcard sampling frequency	48kHz
SPDIF input sampling frequency range	32kHz to 192kHz
SPDIF Output sampling frequency	48kHz

Dual FX Core DSP engine: 2 simultaneous FX engines with independent BPM calculation.

SPECIFICATIONS

Operating levels

Main outputs	0VU = +4dBu
Monitor	0VU = +4dBu
Record	0VU = +4dBu
Maximum output level	+16dBu balanced
Mic Sensitivity	-20dB - -50dB
RIAA input sensitivity 1kHz	70mV = 0VU (200mV max)
Frequency response Line in to Mix out	10Hz - 20kHz +0/-0.5dB
Distortion at 1kHz Line in at +0VU out	0.003% (-90dB) un-weighted
Main Mix noise 22Hz— 22KHz un-weighted	-88dBu (104dB dynamic range)
Residual Mix noise 22Hz— 22KHz un-weighted	-94dBu
Equalization	+6dB boost/-26dB or Total Kill 3 Band
Fader Shutoff	-110dB

See Page 35 for Digital Architecture Specification

Dimensions and Weights

The console is fitted with rubber feet for desktop operation. A screw on rack ear kit is available for 19" rack or plinth mounting.

	Width	Height	Depth	Weight
Desktop	320 mm (12.6")	88 mm (3.5")	358 mm (14")	5.1 kg (11 lbs)
Rack ears fitted	483 mm (19")	88 mm (3.5")	358 mm (14")	
Packed	530 mm (20.9")	470 mm (18.5")	260 mm (10.2")	8.6 kg (19 lbs)

To order a rack ear kit for the XONE:DB2, please quote the part number X:DB4-RK19 (to fit DB4 and DB2).

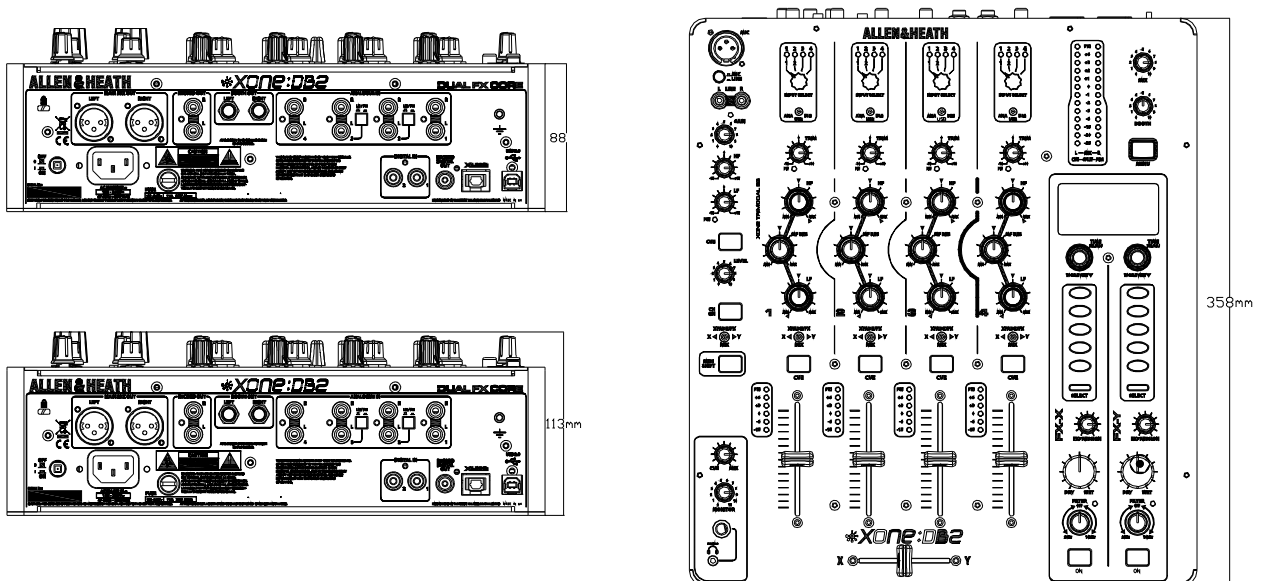

NOTES

PRODUCT REGISTRATION

Registering your product

Please go to www.allen-heath.com/register.asp and register your product's serial number and your details. By registering with us and becoming an official Registered User, you will ensure that any warranty claim you might make is actioned quickly and with the minimum delay.

Alternatively, you may either copy or cut off this section of the page, fill in the details, and return it by mail to:

Allen & Heath Ltd, Kernick Industrial Estate, Penryn, Cornwall TR10 9LU, UK

ALLEN&HEATH PRODUCT REGISTRATION	
Thankyou for buying an Allen & Heath product. We hope that you're happy with it and that you enjoy many years of faithful service with it.	
SERIAL NUMBER	
Please return this section of the card by mail and retain the other part for your records. You can also register online at www.allen-heath.com. Thanks for your help.	
Your Name: _____	
Company Name: _____	
Address 1: _____	
Address 2: _____	
Town/City: _____	County/State: _____
Country: _____	Postcode/Zip: _____
Telephone: _____	
Email: _____	
Why did you choose this console? _____	
Which other products did you consider before choosing A&H? _____	
Is there any thing you would like to improve on this mixer? _____	
What audio magazines do you read? _____	
If you were going to design a mixer for your work, what are the 6 most important features it should have (in order of importance)	
1 _____	2 _____
3 _____	4 _____
5 _____	6 _____
We may use the information you provide to inform you of future product developments. We will not give or sell this data to third parties. Please indicate with an 'x' if you do not wish to receive any further communications from us. <input type="checkbox"/>	