



# DCT-23

Integrated Zone Amplifier



Operation Manual



## **DISCLAIMERS**

The information in this manual has been carefully checked and is believed to be accurate. Cypress Technology assumes no responsibility for any infringements of patents or other rights of third parties which may result from its use.

Cypress Technology assumes no responsibility for any inaccuracies that may be contained in this document. Cypress also makes no commitment to update or to keep current the information contained in this document.

Cypress Technology reserves the right to make improvements to this document and/or product at any time and without notice.

## **COPYRIGHT NOTICE**

No part of this document may be reproduced, transmitted, transcribed, stored in a retrieval system, or any of its part translated into any language or computer file, in any form or by any means—electronic, mechanical, magnetic, optical, chemical, manual, or otherwise—without express written permission and consent from Cypress Technology.

© Copyright 2011 by Cypress Technology.

All Rights Reserved.

Version 1.1 August 2011

## **TRADEMARK ACKNOWLEDGMENTS**

All products or service names mentioned in this document may be trademarks of the companies with which they are associated.





## SAFETY PRECAUTIONS

Please read all instructions before attempting to unpack, install or operate this equipment and before connecting the power supply.

Please keep the following in mind as you unpack and install this equipment:

- Always follow basic safety precautions to reduce the risk of fire, electrical shock and injury to persons.
- To prevent fire or shock hazard, do not expose the unit to rain, moisture or install this product near water.
- Never spill liquid of any kind on or into this product.
- Never push an object of any kind into this product through any openings or empty slots in the unit, as you may damage parts inside the unit.
- Do not attach the power supply cabling to building surfaces.
- Use only the supplied power supply unit (PSU). Do not use the PSU if it is damaged.
- Do not allow anything to rest on the power cabling or allow any weight to be placed upon it or any person to walk on it.
- To protect the unit from overheating, do not block any vents or openings in the unit housing that provide ventilation and allow for sufficient space for air to circulate around the unit.

## REVISION HISTORY

VERSION NO.	DATE DD/MM/YY	SUMMARY OF CHANGE
VS0	20/06/13	Updated text/diagrams
VR0	10/02/15	Preliminary Release
VS1	27/02/14	Added Telnet and Web GUI sections



# CONTENTS

<b>1. Introduction</b> .....	<b>1</b>
<b>2. Applications</b> .....	<b>1</b>
<b>3. Package Contents</b> .....	<b>1</b>
<b>4. System Requirements</b> .....	<b>1</b>
<b>5. Features</b> .....	<b>2</b>
<b>6. Operation Controls and Functions</b> .....	<b>3</b>
6.1 Front Panel .....	3
6.2 Rear Panel.....	4
6.3 Remote Control.....	5
6.4 OLED Menu .....	5
6.5 RS-232 Protocols .....	7
6.5 RS-232 and Telnet Commands .....	7
6.7 Telnet Control .....	9
6.8 Web GUI Control .....	10
<b>7. Connection Diagram</b> .....	<b>11</b>
<b>8. Specifications</b> .....	<b>12</b>
8.1 Technical Specification .....	12
8.2 Audio Specification .....	13
8.3 Amplifier Specification.....	13
<b>9. Acronyms</b> .....	<b>14</b>





## 1. INTRODUCTION

The Integrated Zone Amplifier accepts analog and digital stereo audio signals via RCA, 3.5mm mini-jack, optical and coaxial digital, and HDMI with an additional microphone input. As well as speaker outputs, it boasts line level output, optical and digital outputs, and HDMI outputs for wider systems integration. Suitable for use at musical events, sound presentation and sound amplification. With output audio sampling rate support up to 48kHz and I/O data rate support up to 24-bit, it provides a high quality sound reproduction.

## 2. APPLICATIONS

- Public speech
- Corporate events
- Home systems
- Ceiling speaker systems
- Matrix zone amplification

## 3. PACKAGE CONTENTS

- 1×Integrated Zone Amplifier
- 1×IR Extender
- 1×Remote Control (CR-126)
- 1×24V/3.75A DC Power Adaptor
- 1×Power Cable
- 1×Set of Rack Ears
- 1×Operation Manual

## 4. SYSTEM REQUIREMENTS

Audio source equipment such as DVD/Blu-ray players, PC, CD player, MP3 etc. with output display TV/monitor and active speakers.

## 5. FEATURES

- 30 watts per channel Digital Stereo Amplifier
- Supports Digital to Analog audio Conversion (DAC) and Analog to Digital audio Conversion (ADC)
- HDMI audio embedding and de-embedding
- Supports input audio sampling rates up to 96kHz and output at 48kHz
- Supports HDMI audio sampling rates loop-through and video bypass output
- Supports a wide range of resolutions from 480i to 1080p and VGA to WUXGA (RB)
- Dedicated XLR microphone input with independent volume control
- Supports microphone sound being embedded into video output
- Simultaneous output of sound on both digital and analog
- Analog line output selectable to be either fixed or variable output level
- Supports control via IR (Remote and IR Extender input), RS-232 or IP (Telnet/Web GUI)
- Compact design and easy to use

*Note: Does not support the decoding of Dolby® Digital signals.*

## 6. OPERATION CONTROLS AND FUNCTIONS

### 6.1 Front Panel

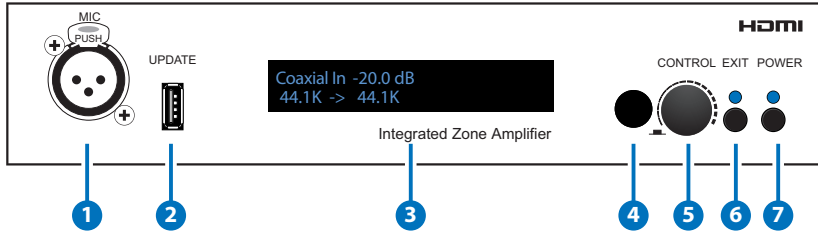

- 1 MIC:** Connect to a microphone or a mono balanced source.
- 2 UPDATE:** Manufacturer use only.
- 3 OLED:** Display current source selection and volume setting.
- 4 IR WINDOW:** Accepts the IR signal from the supplied remote control.
- 5 CONTROL:** Press this button to enter the OLED menu. Turn the wheel to navigate the menu and press it again to enter or confirm the selection. When not in the menu turn the wheel to directly adjust the volume level.
- 6 EXIT:** Press this button to exit the OLED menu. When not in the menu press this button to mute the output, the LED will illuminate in red. Press it again to unmute.
- 7 POWER:** Press this button to turn on the unit, the LED will illuminate in blue to indicate that it is powered. Press it again to switch to standby mode, the LED will turn red to indicate that it is in standby.



## 6.2 Rear Panel

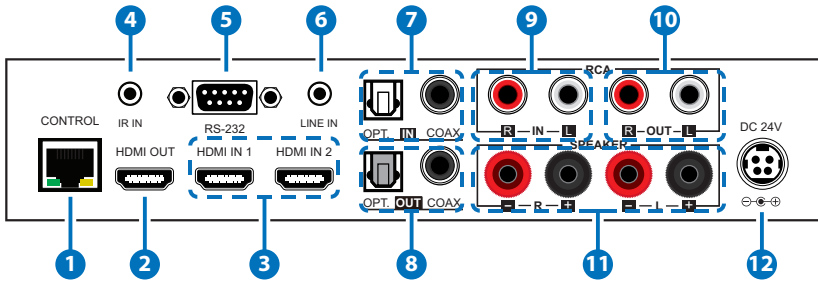

- 1 **CONTROL:** Connect to an active network with RJ45 cable for Telnet/Web GUI control.
- 2 **HDMI OUT:** Connect to HDTV/monitor for both audio and video display.  
*Note: Only the corresponding video for the currently selected HDMI audio input will be output from the HDMI output.*
- 3 **HDMI IN 1/2:** Connect to HDMI source equipment such as a Set-top Box or Blu-ray player.
- 4 **IR IN:** Connect the IR receiver included in the package for receiving the IR signal from the unit's remote control.
- 5 **RS-232:** Connect to a PC/Laptop or control system with D-sub 9-pin cable for RS-232 control.
- 6 **LINE IN:** Connect to an audio source with 3.5mm mini-jack cable for stereo audio signal input.
- 7 **OPT. and COAX. IN:** Connect to source equipment such as a Set-top-box or games console with an optical or coaxial digital output.
- 8 **OPT. and COAX. OUT:** Digital audio output. Connect to additional amplifiers or active speakers.
- 9 **RCA IN:** Connect to audio source equipment with an RCA cable for analog stereo audio input.
- 10 **RCA OUT:** Connect L/R output to active speakers or an additional Integrated Zone Amplifier with an RCA cable for analog stereo audio output.
- 11 **SPEAKER L/R:** Connect to speakers with standard speaker cable.
- 12 **DC 24V:** Connect the 24V DC power supply to the unit and plug the adaptor into an AC outlet.

### 6.3 Remote Control

- 1 **POWER:** Press this button to turn the unit On or to set it into standby mode.
- 2 **MUTE:** Press this button to mute the audio output.
- 3 **VOL. UP (▲) or DOWN (▼):** Press these buttons to turn the output volume up or down.
- 4 **INPUT:** Press these hot keys to switch the required input source directly.
- 5 **MENU:** Press this button to enter the OLED MENU then press the up or down buttons to select the required option and press it again to confirm the selection.
- 6 **EXIT:** Press this button to go back one step or exit from the menu.

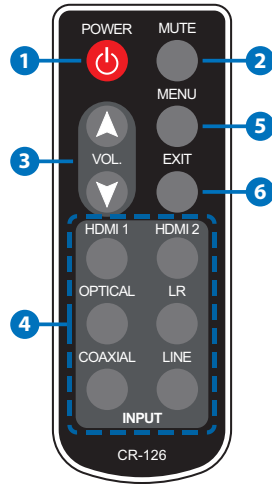

### 6.4 OLED Menu

MAIN MENU	SUB MENU	ADJUSTMENTS
<b>Function Select</b>	Audio In	
	HDMI Set	
	Display Set	
	MIC Set	
	Line Out Set	
	IP Config	
	Reset to Default	

MAIN MENU	SUB MENU	ADJUSTMENTS
<b>Audio Select</b>	HDMI1	
	HDMI2	
	Optical In	
	Coaxial In	
	Line In	
	RCA (L/R) In	
<b>HDMI Setting</b>	Video	HDMI 1
		HDMI 2
	Audio	HDMI 1
		Ext Audio
<b>Display Set</b>	Timeout 5s	
	Timeout 10s	
	Timeout 15s	
<b>Mic Setting</b>	Off	
	Normal	
	Phantom	
	Line Mode	
	Volume	
<b>Line Out Setting</b>	Fix Level	
	Default	
<b>IP Configuration</b>	IP	
	SN	
	GN	
<b>Reset To Default</b>	OK	

## 6.5 RS-232 Protocols

AMPLIFIER			REMOTE CONTROL	
PIN	ASSIGNMENT		PIN	ASSIGNMENT
1	NC		1	NC
2	Tx		2	Rx
3	Rx		3	Tx
4	NC	▶	4	NC
5	GND	◀	5	GND
6	NC		6	NC
7	NC		7	NC
8	NC		8	NC
9	NC		9	NC

Baud Rate: 115200bps

Data bit: 8 bits

Parity: None

Flow Control: None

Stop Bit: 1

## 6.5 RS-232 and Telnet Commands

COMMAND	DESCRIPTION
<b>HELP</b>	Display list of commands.
<b>H</b>	Alias for HELP.
<b>?</b>	Alias for HELP.
<b>PWR S/0/1</b>	Power control. S=Status, 0=Off, 1=On
<b>SOURCE S/0~5</b>	Source in selection. S=Status, 0=HDMI 1, 1=HDMI 2, 2=Opt, 3=Coax, 4=Line In, 5=RCA In

COMMAND	DESCRIPTION
<b>VOL S/0~-80</b>	Output volume setting of 0~80db. S=Show Volume, +=0.5db, ++=2db, -=-0.5db, ---2db or 0~-80db
<b>MUTE S/0/1</b>	Output volume mute control. S=Status, 0=Unmute, 1=Mute
<b>MICVOL S/0~30</b>	Mic volume control 0~30db. S=Show Volume, +=0.5db, -=-0.5db or 0~30db
<b>MICMODE S/0~3</b>	Mic mode select. S=Status, 0=Off, 1=Normal, 2=Phantom, 3=Line mode
<b>FADEFAULT</b>	Factory default setting.
<b>REBOOT</b>	Reboot the unit.
<b>IPCONFIG</b>	Print the IP configuration to the screen.
<b>RESETIP</b>	Reset the IP configuration to factory defaults.
<b>SHOWMAC</b>	Print the MAC address to the screen.
<b>SHOWTPORT</b>	Print the Telnet communication port to the screen.
<b>SHOWHPORT</b>	Print the HTTP communication port to the screen.
<b>SIPADD</b>	Set the IP address.
<b>SNETMASK</b>	Set the Net Mask address.
<b>SGATEWAY</b>	Set the Gateway address.
<b>SHTTTPORT</b>	Set the HTTP communication port (1~62235) [Default values=80].
<b>STELNETPPORT</b>	Set the Telnet communication port (1~62235) [Default values=23].

*Note: RS-232 commands will be not executed unless followed by a carriage return. Commands are case-sensitive.*

## 6.7 Telnet Control

Before using the Telnet control, please ensure that both the Integrated Zone Amplifier (via the 'CONTROL' port) and the PC/Laptop are connected to the same active network.

To access the Telnet control in Windows 7, click on the 'Start' menu and type "cmd" in the Search field then press enter.

Under Windows XP go to the 'Start' menu and click on "Run", type "cmd" with then press enter.

In the Mac OS X Finder select Go→Applications→Utilities→Terminal from the taskbar (See below for reference).

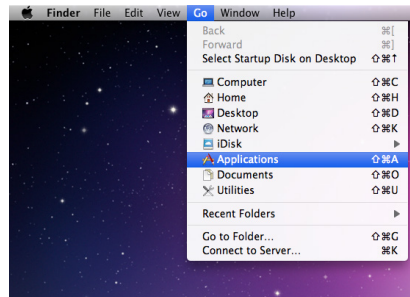

Once in the command line interface (CLI) type "telnet", then the IP address and hit enter.

*Note: The IP address of the Integrated Zone Amplifier can be displayed on the unit's OLED monitor by navigating to the IP Config option in the settings menu.*

```
Microsoft Windows [Version 6.1.7601]
Copyright (c) 2009 Microsoft Corporation. All rights reserved.

C:\Users\Administrator>telnet 192.168.5.80 23
```

This will bring us into the unit which we wish to control. Type "H" to list the available commands.

```

HELP : DISPLAY LIST OF COMMANDS
H : ALIAS FOR HELP
? : ALIAS FOR HELP
PUR : POWER CONTROL. <S:STATUS 0:OFF 1:ON>
SOURCE : SOURCE IN SELECT. <S:STATUS 0:HDMI1 1:HDMI2 2:OPT. 3:COAX. 4:LINE IN 5:
RCA IN>
VOL : OUTPUT VOLUME SETTING. <S:SHOWVOL ++:+0.5dB ++:+2dB --:-0.5dB --:-2dB or 0"-
30 dB>
MUTE : OUTPUT VOLUME MUTE CONTROL. <S:STATUS 0:UN-MUTE 1:MUTE>
MICVOL : MIC VOLUME CONTROL. <S:SHOWVOL ++:+0.5dB --:-0.5dB or 0"30 dB>
MICMODE : MIC MODE SELECT. <S:STATUS 0:OFF 1:NORMAL 2:PHANTOM 3:LINE MODE>
FADEFAULT : FACTORY DEFAULT SETTING
REBOOT : REBOOT THE UNIT
RESETIP : RESET THE IP CONFIGURATION TO FACTORY DEFAULTS
IPCONFIG : PRINT THE IP CONFIGURATION TO THE SCREEN
SHOWMAC : PRINT THE MAC ADDRESS TO THE SCREEN
SHOWTPORT : PRINT THE TELNET COMMUNICATION PORT TO THE SCREEN
SHOWHPORT : PRINT THE HTTP COMMUNICATION PORT TO THE SCREEN
SIPADD : SET THE IP ADDRESS
SNETMASK : SET THE NET MASK ADDRESS
SGATEWAY : SET THE GATEWAY ADDRESS
SHITPPORT : SET THE HTTP COMMU
  
```

Type "IPCONFIG" to show all IP configurations. To reset the IP, type "RESETIP".

*Note: All the commands will be not executed unless followed by a carriage return. Commands are case-sensitive. If the IP is changed then the IP Address required for Telnet access will also change accordingly.*

## 6.8 Web GUI Control

On a PC/Laptop that is connected to the same active network as the Integrated Zone Amplifier, open a web browser and type unit's IP address into the web address entry bar. The browser will display the unit's control page.

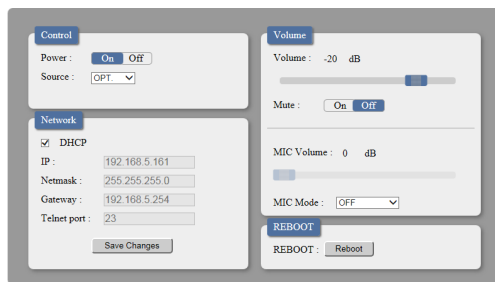

## 7. CONNECTION DIAGRAM

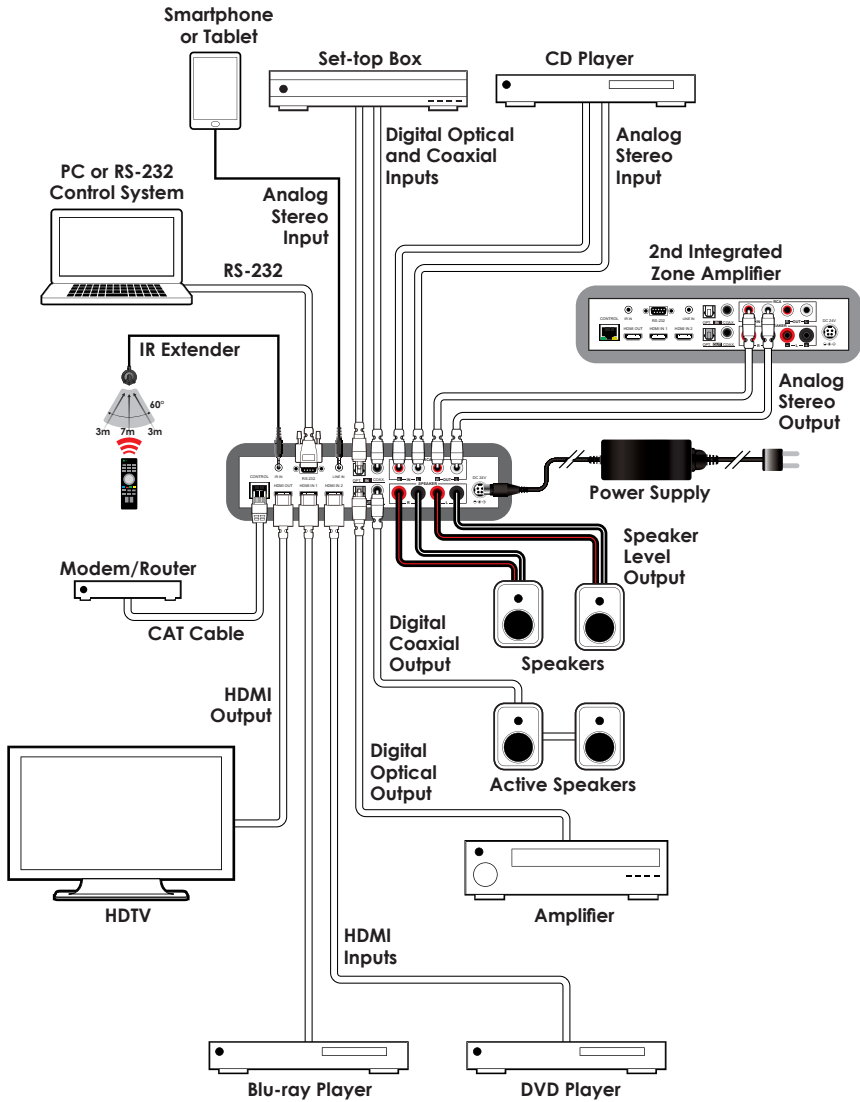



## 8. SPECIFICATIONS

### 8.1 Technical Specification

<b>Input Ports</b>	2×HDMI, 1×Optical, 1×Coaxial, 1×3.5mm Mini-jack, 2×RCA (Analog Stereo), 1×Microphone, 1×D-sub 9-pin (RS-232), 1×RJ-45 (Control), 1×IR Extender
<b>Output Ports</b>	1×HDMI, 1×Optical, 1×Coaxial, 2×RCA (Analog Stereo), 1×Speaker
<b>Digital Audio Input/Output</b>	LPCM 2CH
<b>Stereo Input/Output Level</b>	2 Vrms ± 0.2
<b>HDMI Cable Distance</b>	Up to 15m@1080p/12-bit
<b>IR Frequency</b>	38 kHz
<b>ESD Protection</b>	Human body model: ±8kV (air-gap discharge) ±4kV (contact discharge)
<b>Power Supply</b>	24V/3.75A DC (US/EU standards, CE/FCC/UL certified)
<b>Dimensions</b>	215 mm (W)×172.5mm (D)×46mm (H)
<b>Weight</b>	1060g
<b>Chassis Material</b>	Aluminum
<b>Silkscreen Color</b>	Black
<b>Operating Temperature</b>	Operating from 0 °C ~ 40 °C
<b>Storage Temperature</b>	-20°C ~ 60°C /-4 °F ~ 140 °F
<b>Relative Humidity</b>	20 ~ 90% RH (non-condensing)
<b>Power Consumption</b>	82.5W
<b>Power Output</b>	30W/Channel@8 Ohm (0.1% THD+N)

## 8.2 Audio Specification

Input Level/Freq	Output Interface	Output Level	T.H.D+N	Freq Response	SNR
HDMI 1/2 OPTICAL COAX 0 dBFS/1 kHz	HDMI	0dB±1 dB	<0.01 %	±1 dBFS	>80 dB
	OPTICAL				
	COAX				
	L/R	2.0Vrms ±10%	<0.1 %	±1 dBFS	>70 dB
Analog L/R Phone Jack 2.0Vrms/1 kHz	HDMI	0dB±1 dB	<0.01 %	±1 dBFS	>80 dB
	OPTICAL				
	COAX				
	L/R	2.0Vrms ±10%	<0.1 %	±1 dBFS	>80 dB

## 8.3 Amplifier Specification

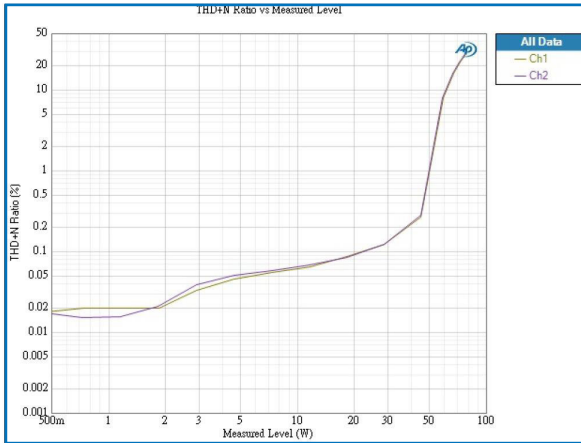

## 9. ACRONYMS

ACRONYM	COMPLETE TERM
<b>CAT5e</b>	Category 5 Cable
<b>CAT6</b>	Category 6 Cable
<b>COAX</b>	Coaxial
<b>HDMI</b>	High-Definition Multimedia Interface
<b>OLED</b>	Organic Light-Emitting Diode
<b>OPT</b>	Optical



**CYPRESS TECHNOLOGY CO., LTD**

Home page: <http://www.cypress.com.tw>