

ULTRA HD

4x1

SOURCES DISPLAY

Switcher for HDMI
with Ultra HD
4K x 2K support

GTB-HD4K2K-441
GTB-HD4K2K-441-BLK

User Manual

Release A1



Gefen
TOOLBOX®

Important Safety Instructions

GENERAL SAFETY INFORMATION

1. Read these instructions.
2. Keep these instructions.
3. Heed all warnings.
4. Follow all instructions.
5. Do not use this product near water.
6. Clean only with a dry cloth.
7. Do not block any ventilation openings. Install in accordance with the manufacturer's instructions.
8. Do not install or place this product near any heat sources such as radiators, heat registers, stoves, or other apparatus (including amplifiers) that produce heat.
9. Do not defeat the safety purpose of the polarized or grounding-type plug. A polarized plug has two blades with one wider than the other. A grounding type plug has two blades and a third grounding prong. The wide blade or the third prong are provided for your safety. If the provided plug does not fit into your outlet, consult an electrician for replacement of the obsolete outlet.
10. Protect the power cord from being walked on or pinched particularly at plugs, convenience receptacles, and the point where they exit from the apparatus.
11. Only use attachments/accessories specified by the manufacturer.
12. To reduce the risk of electric shock and/or damage to this product, never handle or touch this unit or power cord if your hands are wet or damp. Do not expose this product to rain or moisture.
13. Unplug this apparatus during lightning storms or when unused for long periods of time.
14. Refer all servicing to qualified service personnel. Servicing is required when the apparatus has been damaged in any way, such as power-supply cord or plug is damaged, liquid has been spilled or objects have fallen into the apparatus, the apparatus has been exposed to rain or moisture, does not operate normally, or has been dropped.
15. Batteries that may be included with this product and/or accessories should never be exposed to open flame or excessive heat. Always dispose of used batteries according to the instructions.

Warranty Information

Gefen warrants the equipment it manufactures to be free from defects in material and workmanship.

If equipment fails because of such defects and Gefen is notified within two (2) years from the date of shipment, Gefen will, at its option, repair or replace the equipment, provided that the equipment has not been subjected to mechanical, electrical, or other abuse or modifications. Equipment that fails under conditions other than those covered will be repaired at the current price of parts and labor in effect at the time of repair. Such repairs are warranted for ninety (90) days from the day of reshipment to the Buyer.

This warranty is in lieu of all other warranties expressed or implied, including without limitation, any implied warranty or merchantability or fitness for any particular purpose, all of which are expressly disclaimed.

1. Proof of sale may be required in order to claim warranty.
2. Customers outside the US are responsible for shipping charges to and from Gefen.
3. Copper cables are limited to a 30 day warranty and cables must be in their original condition.

The information in this manual has been carefully checked and is believed to be accurate. However, Gefen assumes no responsibility for any inaccuracies that may be contained in this manual. In no event will Gefen be liable for direct, indirect, special, incidental, or consequential damages resulting from any defect or omission in this manual, even if advised of the possibility of such damages. The technical information contained herein regarding the features and specifications is subject to change without notice.

For the latest warranty coverage information, refer to the Warranty and Return Policy under the Support section of the Gefen Web site at www.gefen.com.

PRODUCT REGISTRATION

Please register your product online by visiting the Register Product page under the Support section of the Gefen Web site.

Contacting Gefen Technical Support

Gefen, LLC
c/o Customer Service
20600 Nordhoff St.
Chatsworth, CA 91311

Telephone: (818) 772-9100
(800) 545-6900

Fax: (818) 772-9120

Email: support@gefentoolbox.com

Visit us on the Web: www.gefentoolbox.com

Technical Support Hours: 8:00 AM to 5:00 PM Monday - Friday, Pacific Time

4x1 Switcher for HDMI 4K x 2K is a trademark of Gefen, LLC.

Important Notice

Gefen, LLC reserves the right to make changes in the hardware, packaging, and any accompanying documentation without prior written notice.

HDMI, the HDMI logo, and High-Definition Multimedia Interface are trademarks or registered trademarks of HDMI Licensing in the United States and other countries.

© 2013 Gefen, LLC. All Rights Reserved.
All trademarks are the property of their respective owners.

Operating Notes

- EDID contains the A/V capabilities of a display device in regards to video resolutions and audio formats supported. This information is used by the source device to determine the format of the A/V signal on the outputs. The GefenToolBox 4x1 Switcher for HDMI 4K x 2K incorporates advanced EDID management to ensure compatibility with all sources and display devices.
- The GefenToolBox 4x1 Switcher for HDMI 4K x 2K can detect the presence of Deep Color (12-bit signal) automatically and will disable Deep Color EDID features across all other outputs if any connected device or display is not capable of processing Deep Color. This automatic behavior ensures compatibility among all output devices in a mixed-device environment. This feature cannot be disabled.
- When powering the GefenToolBox 4x1 Switcher for HDMI 4K x 2K or if the EDID mode is changed, the switcher will undergo a momentary initialization sequence. This is normal operation and may take a few seconds.
- The best way to operate and configure this unit is to use the built-in Web interface, which can be accessed by entering the IP address of the switcher into the address bar of any Web browser. See the section [RS-232 and IP Configuration](#) for more information about this feature.

Features and Packing List

Features

- Switches between four Ultra Hi-Def sources to one Ultra HD display
- Supports resolutions up to Ultra HD 4K x 2K (3840 x 2160 @ 30Hz) and 1080p Full HD
- Supports 12-bit Deep Color
- 3DTV pass-through
- Lip Sync pass-through
- Push button control for routing sources to display
- Supports LPCM 7.1, Dolby® TrueHD, and DTS-HD Master Audio™
- Supports the use of DVI sources and DVI displays with HDMI-to-DVI adapters (not included)
- RS-232 Serial interface for remote control using a computer or automation control system
- IP control via Telnet, UDP, and the built-in web server interface
- IR remote control
- IR Extender port allows the unit to be mounted in a hidden location
- Field-upgradeable firmware via Mini-USB and IP ports
- Locking Power Supply
- Surface-mountable
- Available in Black or White



Packing List

The 4x1 Switcher for HDMI 4K x 2K ships with the items listed below. If any of these items are not present in your box when you first open it, immediately contact your dealer or Gefen.

- 1 x 4:1 Switcher for HDMI 4K x 2K
- 1 x IR Remote Control
- 1 x 5V DC Power Supply
- 1 x Quick-Start Guide

Table of Contents

01 Getting Started

Panel Layout	2
IR Remote Control Unit	4
Front	4
Back	5
Installing the Battery	6
Setting the IR Channel	6
Installation	7
Connecting the 4x1 Switcher for HDMI 4K x 2K	7
Sample Wiring Diagram	7

02 Operating the 4x1 Switcher for HDMI 4K x 2K

Switching Inputs	10
Using the Front Panel Buttons	10
Using the IR Remote Control	11

03 Advanced Operation

RS-232 and IP Configuration	14
RS-232 Interface	14
RS-232 Settings	14
IP / UDP Configuration	15
Commands	16
Configuration	16
IP / Telnet Configuration	35
Masking	47
Routing / Naming / +5V / Presets	49
Status	54
Web Interface	58
Using the built-in Web Server	58
Main ► Routing	59
Main ► I/O Status	62
Main ► Display Info	64
I/O Setup ► I/O Names	65
I/O Setup ► HPD Control	66
I/O Setup ► HDCP	67
Manage EDID ► Assign	68
Manage EDID ► Bank Names	71
Manage EDID ► Upload/Download	72
Configuration ► Change IP Settings	74
Configuration ► Telnet Login Settings	75
Configuration ► UDP Connection Settings	76

Configuration ► Web Login Settings 77
Configuration ► System Configuration 78

04 Appendix

Wall Mounting Instructions 84
Firmware Upgrade Procedure 85
Specifications 86



4x1
SOURCES | DISPLAY

**Switcher for HDMI
with Ultra HD
4K x 2K support**

01 Getting Started

Panel Layout	2
IR Remote Control Unit	4
Front	4
Back	5
Installing the Battery	6
Setting the IR Channel	6
Installation	7
Connecting the 4x1 Switcher for HDMI 4K x 2K	7
Sample Wiring Diagram	7

Panel Layout

(Black finish shown)

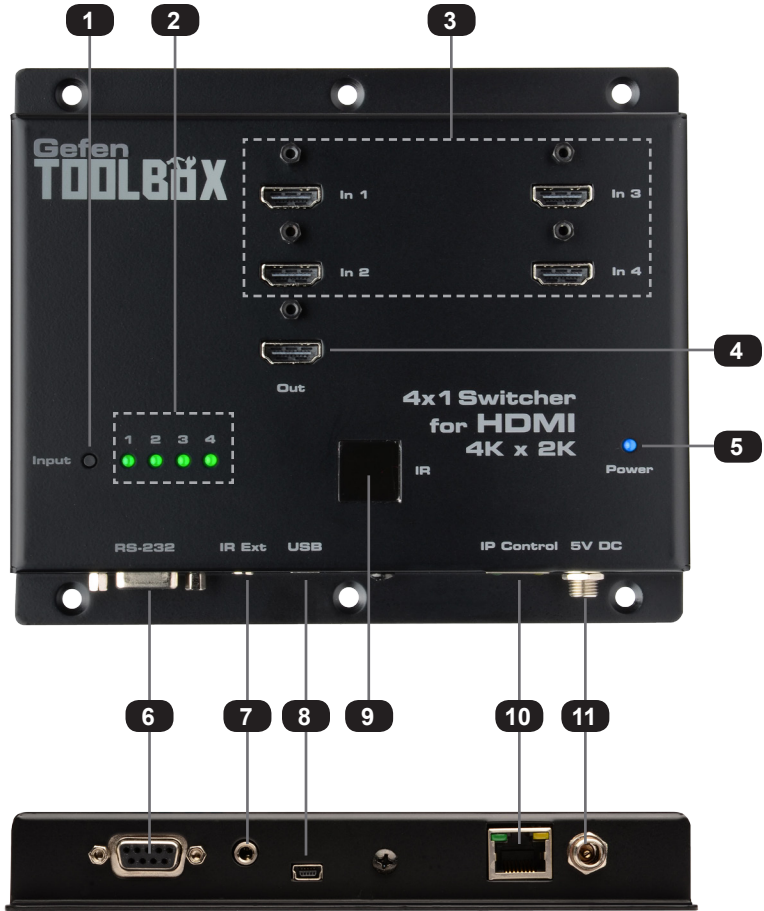

ID	Name	Description
1	Input	Press this button to switch between each of the four inputs on the switcher.
2	Input Indicators	Displays the currently selected input.
3	In (1 - 4)	Connect an HDMI cable from an Ultra Hi-Def source to any of these HDMI ports.
4	Out	Connect an Ultra HD display to this port using an HDMI cable.
5	Power	This LED indicator will glow bright blue when the included 5V DC power supply is connected between the switcher and an available electrical outlet.
6	RS-232	Connect an RS-232 cable from this port to an RS-232 device. See RS-232 and IP Configuration for more information.
7	IR Ext	Connect an IR Extender (Gefen part no. EXT-RMT-IREXTN) to this port.
8	USB	Used for upgrading the firmware. See Firmware Upgrade Procedure for more information.
9	IR	This IR sensor receives signals from the included IR remote control unit.
10	IP Control	Connect an Ethernet cable between this jack and a LAN to use IP control. See RS-232 and IP Configuration for more information.
11	5V DC	Connect the included 5V DC power supply to this locking power receptacle.

IR Remote Control Unit

Front

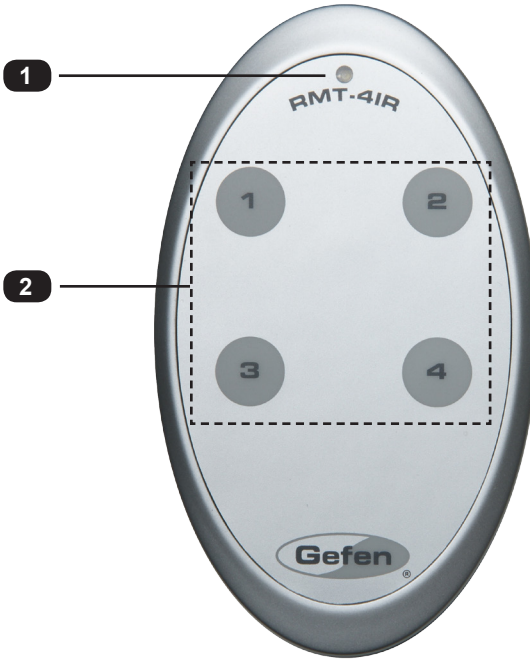

ID	Name	Description
1	Activity indicator	This LED glows bright orange when a key is pressed on the remote.
2	1, 2, 3, 4	Press these button to switch to the desired input (source).



NOTE: An Activity indicator that flashes quickly while holding down any one of the buttons indicates a low battery. Replace the battery as soon as possible. See [Installing the Battery](#).

Back

(shown with cover removed)

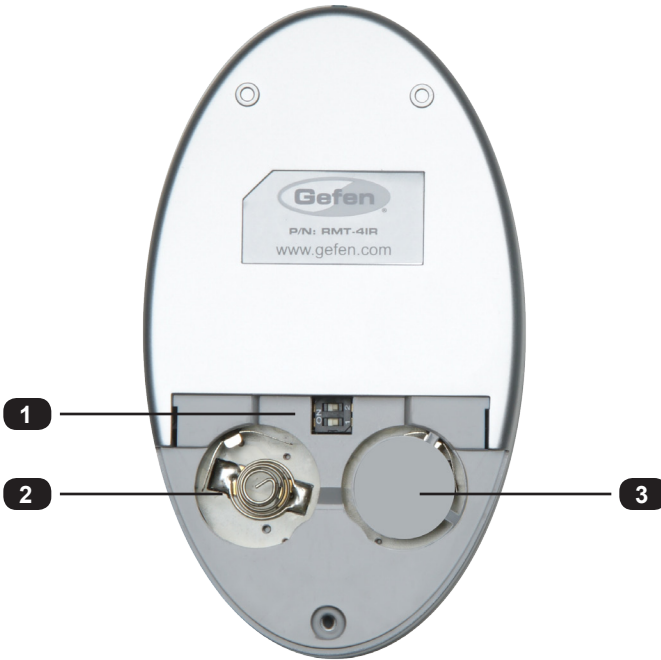

ID	Name	Description
1	DIP switch bank	Use these DIP switches to set the IR channel of the remote. See Setting the IR Channel for more information.
2	Primary battery slot (shown without battery)	Holds the battery for operating the remote. Use only 3V CR2032-type batteries. Make sure that the positive (+) side of the battery is facing up.
3	Alternate battery slot	Allows for the installation of secondary (backup) battery.

Installing the Battery

The IR remote control unit ships with two batteries. Only one battery is required for operation. The second battery is a spare.



WARNING: Use only 3V CR2032-type batteries. Risk of explosion if battery is replaced by an incorrect type. Dispose of used batteries according to the instructions.

1. Remove the back cover the IR Remote Control unit.
2. Insert the included battery into the primary battery slot. The positive (+) side of the battery should be facing up.
3. Replace the back cover.

Setting the IR Channel

In order for the included IR remote control to communicate with the 4x1 Switcher for HDMI 4K x 2K, the IR remote control must be set to the same channel as the switcher. Use the `#set_ir` command to set the IR channel of the switcher.



IR Channel	DIP settings
0 (default)	
1	
2	
3	

Installation

Connecting the 4x1 Switcher for HDMI 4K x 2K

1. Connect up to four Ultra Hi-Def sources to the **In** (1 - 4) ports on the switcher.
2. Connect an Ultra Hi-Def display to the **Out** port on the switcher.
3. OPTIONAL: Connect an RS-232 cable from the **RS-232** port on the switcher to the RS-232 connector on the serial controller (e.g. Gefen PACS, etc).
4. OPTIONAL: Connect an Ethernet cable from the **IP Control** port on the switcher to a Local Area Network (LAN).
5. OPTIONAL: Connect an IR extender to the **IR Ext** port on the switcher.
6. Connect the included 5V DC locking power supply to the **5V DC** power receptacle on the switcher. Do not overtighten the locking power connector.
7. Connect the power supply to an available electrical outlet.

Sample Wiring Diagram

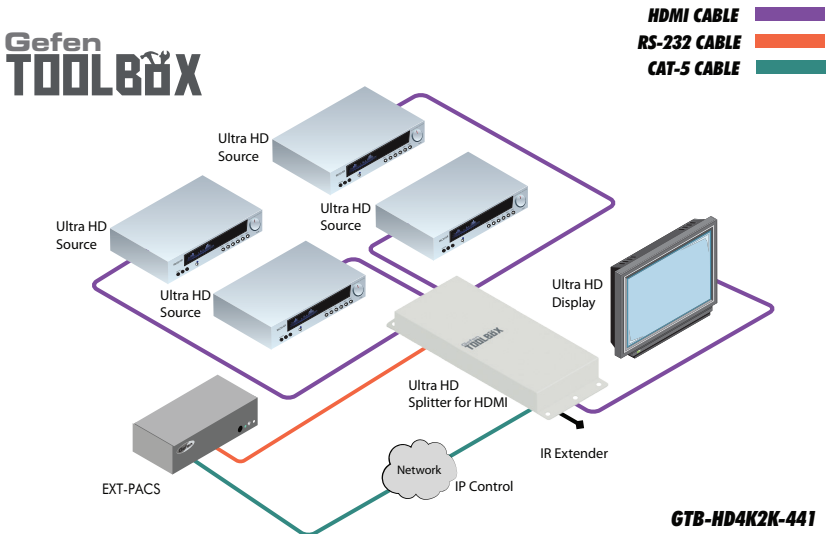



4x1
SOURCES | DISPLAY

**Switcher for HDMI
with Ultra HD
4K x 2K support**

02 Operating the 4x1 Switcher for HDMI 4K x 2K

Switching Inputs	10
Using the Front Panel Buttons	10
Using the IR Remote Control	11

Switching Inputs

Using the Front Panel Buttons

The front panel of the 4x1 Switcher for HDMI 4K x 2K has a set of four (4) LED indicators which are associated with each input on the switcher. Each input can be routed to the output. Press the **Input** button to cycle through each of the inputs.

1. When the switcher is powered-on for the first time, Input 1 (**In 1**) will automatically be selected.



2. Press the **Input** button to select Input 2 (**In 2**). Consecutively press the **Input** button until the desired input is selected. Once Input 4 (**In 4**) is selected, press the **Input** again to return to Input 1 (**In 1**).



Using the IR Remote Control

The included IR remote control unit can also be used to switch between each input. The front panel of the 4x1 Switcher for HDMI 4K x 2K has a set of four (4) LED indicators which are associated with each input on the switcher.

1. When the switcher is powered-on for the first time, Input 1 (In 1) will automatically be selected.
2. Point the included IR remote control unit at the IR sensor on the top panel. If an IR extender is being used, then both IR sensors will be used to receive IR signals.
3. Each button on the IR remote control unit represents an input. Press the desired button on the IR remote control to switch to that input.





4x1
SOURCES DISPLAY

**Switcher for HDMI
with Ultra HD
4K x 2K support**

03 Advanced Operation

RS-232 and IP Configuration	14
RS-232 Interface	14
RS-232 Settings	14
IP / UDP Configuration	15
Commands	16
Configuration	16
IP / Telnet Configuration	35
Masking	47
Routing / Naming / +5V / Presets	49
Status	54
Web Interface	58
Using the built-in Web Server	58
Main ▶ Routing	59
Main ▶ I/O Status	62
Main ▶ Display Info	64
I/O Setup ▶ I/O Names	65
I/O Setup ▶ HPD Control	66
I/O Setup ▶ HDCP	67
Manage EDID ▶ Assign	68
Manage EDID ▶ Bank Names	71
Manage EDID ▶ Upload/Download	72
Configuration ▶ Change IP Settings	74
Configuration ▶ Telnet Login Settings	75
Configuration ▶ UDP Connection Settings	76
Configuration ▶ Web Login Settings	77
Configuration ▶ System Configuration	78

RS-232 and IP Configuration

RS-232 Interface

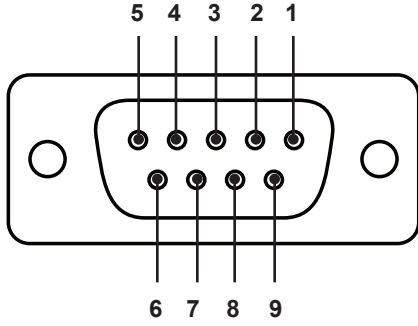

RS-232 Controller

Switcher

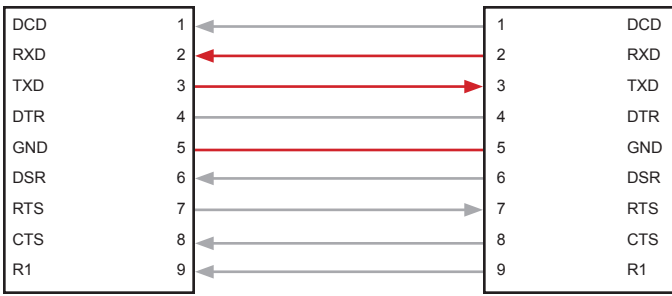

Only TXD, RXD, and GND pins are used.

RS-232 Settings

Description	Setting
Baud rate	19200
Data bits	8
Parity	None
Stop bits	1
Hardware flow control	None



IMPORTANT: When sending RS-232 commands, a carriage return must be included at the end of the command. A space *must* be included between the command and the parameter.

IP / UDP Configuration

The 4x1 Switcher for HDMI 4K x 2K supports IP-based control using Telnet, UDP, or the built-in Web-based GUI. To set up IP control, the network settings for the 4x1 Switcher for HDMI 4K x 2K must be configured via RS-232. The default network settings for the switcher are as follows:

Description	IP Address / Port	Description	IP Address / Port
IP Address	192.168.1.72	UDP Port	23
Subnet	255.255.255.0	Local UDP Port	50007
Gateway	192.168.1.254	Remote UDP IP	192.168.1.255
HTTP Port	80	Remote UDP Port	50008

1. Connect an RS-232 cable from the PC to the 4x1 Switcher for HDMI 4K x 2K. Also make sure that an Ethernet cable is connected between the switcher and the network.
2. Launch a terminal emulation program (e.g. HyperTerminal) and use the RS-232 settings listed on the previous page.



NOTE: Depending upon the network, all related IP, Telnet, and UDP settings will need to be assigned. Consult your network administrator to obtain the proper settings.

3. Set the IP address for the switcher using the `#sipadd` command.
4. Set the subnet mask using the `#snetmask` command.
5. Set the gateway (router) IP address using the `#sgateway` command.
6. Set the Telnet listening port using the `#set_telnet_port` command.
7. Set the HTTP listening port using the `#set_http_port` command.
8. Set the UDP remote IP address for the switcher using the `#set_udp_remote_ip` command.
9. Set the UDP listening port for the switcher using the `#set_udp_port` command.
10. Set the UDP remote port for the switcher using the `#set_udp_remote_port` command.
11. Reboot the switcher to apply all changes, then type the IP address that was specified in step 3, in a Web browser to access the Web GUI. Use the same IP address to Telnet to the switcher.

Commands

Configuration

Command	Description
<code>#echo</code>	Enables / disables RS-232 feedback
<code>#fadefault</code>	Resets the routing and masking to factory-default settings
<code>#hdcp</code>	Enables / disables HDCP detection
<code>#hdp_pulse</code>	Cycles with HPD line on the specified output
<code>#lock_edid</code>	Locks the local EDID when the switcher is power-cycled
<code>#power</code>	Toggles the power on the switcher
<code>#reboot</code>	Reboots the switcher
<code>#set_edid</code>	Sets the specified EDID to an input or bank
<code>#set_ir</code>	Sets the IR channel for the switcher
<code>#set_udp_port</code>	Sets the local UDP listening port
<code>#set_udp_remote_ip</code>	Sets the remote UDP IP address
<code>#set_udp_remote_port</code>	Sets the remote UDP listening port
<code>#show_hdcp</code>	Displays the HDCP status of the specified input
<code>#show_ir</code>	Displays the current IR channel of the switcher
<code>#show_out_colordpt</code>	Displays the maximum color depth supported by the display (sink) device based on the EDID
<code>#show_out_res</code>	Displays the maximum video resolution supported by the display (sink) device, based on the EDID
<code>#show_udp_port</code>	Displays the current local UDP listening port
<code>#show_udp_remote_ip</code>	Displays the current remote UDP IP address
<code>#show_udp_remote_port</code>	Displays the current remote UDP listening port
<code>#use_udp_enable</code>	Enables / disables UDP access
<code>n</code>	Displays the routing status of the output
<code>s</code>	Routes the specified input to the output

#echo

The #echo command enables / disables (toggles) the RS-232 feedback.

Syntax:

```
#echo param1
```

Parameters:

param1 Value [0 ... 1]

Value	Description
0	Disable feedback
1	Enable feedback

Example:

```
#echo 1
```

```
LOCAL ECHO IS ON
```

#fadefault

The #fadefault command resets the switcher to factory-default settings. Outputs are unmasked and all IP and UDP settings are reset to default settings.

Syntax:

```
#fadefault
```

Parameters:

None

Example:

```
#fadefault
```

```
SWITCHER WAS RESET TO FACTORY DEFAULTS.  
RESET SWITCHER ROUTING  
OUTPUT IS UNMASKED
```

```
RESET USER DEFINE NAME  
RESET IP CONFIGURATIONS  
RESET WEBGUI CONFIGURATIONS
```

```
SWITCHER WILL REBOOT SHORTLY *REBOOT UNIT IN 3 SECONDS
```

```
GTB-HD4K2K-441 v0.7U
```

#hdcp

The #hdcp command enables / disables HDCP detection on the selected input.



NOTE: Some computers will enable HDCP if an HDCP-compliant display is detected. Set *param2* = 1 to force the computer to ignore detection of an HDCP-compliant display. Setting *param2* = 0 does **not** decrypt HDCP content.

Syntax:

```
#hdcp param1 param2
```

Parameters:

<i>param1</i>	Input	[1 ... 4]
<i>param2</i>	Value	[0 ... 1]

Value	Description
0	Disable
1	Enable

Example:

```
#hdcp 2 0
INPUT 2 HDCP IS DISABLED
```

```
#hdcp 2 1
INPUT 2 HDCP IS ENABLED
```

#hdp_pulse

The #hdp_pulse command cycles the HPD line on the specified input. Issuing this command is identical to physically disconnecting and reconnecting the cable between the source and the switcher. If *param1* = 0, then all inputs will receive the HPD pulse.

Syntax:

```
#hdp_pulse param1
```

Parameters:

<i>param1</i>	Input	[1 ... 4]
---------------	-------	-----------

Examples:

```
#hdp_pulse 1  
HPD PULSE HAS BEEN SENT TO INPUT 1
```

```
#hdp_pulse 0  
HPD PULSE HAS BEEN SENT TO ALL INPUTS
```

#lock_edid

The #lock_edid command secures the Local EDID by disabling the automatic loading of the downstream EDID when the switcher is powered.

Syntax:

```
#lock_edid param1
```

Parameters:

param1 Value [0 ... 1]

Value	Description
0	Disable
1	Enable

Examples:

```
#lock_edid 0  
SWITCHER EDID IS UNLOCKED
```

```
#lock_edid 1  
SWITCHER EDID IS LOCKED
```

#power

The #power command toggles power on the switcher.

Syntax:

```
#power param1
```

Parameters:

param1 Value [0 ... 1]

Value	Description
0	Off
1	On

Examples:

```
#power 0  
(switcher will power-off)
```

```
#power 1  
(switcher will power-on)
```

#reboot

The `#reboot` command reboots the switcher. Executing this command is the equivalent of disconnecting and reconnecting the AC power cord, on the back of the switcher. The switcher must be rebooted after changing any of the IP settings.

Syntax:

```
#reboot
```

Parameters:

None

Example:

```
#reboot
```

```
SWITCHER WILL REBOOT SHORTLY *REBOOT UNIT IN 3 SECONDS
```

```
GTB-HD4K2K-441 v0.7U
```

#set_edid

The #set_edid command sets the specified EDID type to an input or bank.

Syntax:

```
#set_edid param1 param2 param3 param4
```

Parameters:

param1 Source [STRING]

Source	Description
default	Uses default (Internal) EDID
dynamic	Uses dynamic EDID
bank	Uses EDID bank
output	Uses EDID on Output (sink)

param2 Source [0 ... 8]

Source	Description
0	Default EDID
1 ... 8	EDID bank
1	Output

param3 Target [STRING]

Target	Description
input	Specifies an input
bank	Specifies an EDID bank

param4 Target [1 ... 8]

Value	Description
1 ... 4	Input
1 ... 8	EDID bank

(continued on next page)

Notes:

If *param1* = default or *param1* = dynamic, then set *param2* = 0.

Examples:

```
#set_edid default 0 input 4  
COPY DEFAULT EDID TO INPUT 4
```

```
#set_edid output 1 input 3  
COPY OUTPUT1 EDID TO INPUT3
```

```
#set_edid dynamic 0 input 2  
COPY DYNAMIC EDID TO INPUT 2
```

```
#set_edid bank 3 input 4  
COPY BANK 3 EDID TO INPUT 4
```

#set_ir

The #set_ir command sets the IR channel for the switcher. The default IR channel setting is 0. The IR channel for the switch can also be set under the **Configuration** tab within the Web interface. See [Configuration](#) ► [System Configuration](#) for more information.

Syntax:

```
#set_ir param1
```

Parameters:

param1 Channel [0 ... 3]

Channel	Description
0	Set IR channel 0
1	Set IR channel 1
2	Set IR channel 2
3	Set IR channel 3

Example:

```
#set_ir 1
```

```
IR CHANNEL IS SET TO CHANNEL 1
```

#set_udp_port

The `#set_udp_port` command sets the local UDP server listening port. The default port setting is 21. The switcher must be rebooted after executing this command. Use the `#show_udp_port` command to display the current local UDP listening port.

Syntax:

```
#set_udp_port param1
```

Parameters:

<i>param1</i>	Port	[0 ... 65535]
---------------	------	---------------

Example:

```
#set_udp_port 56
```

```
UDP COMMUNICATION PORT 56 IS SET.  
PLEASE REBOOT THE UNIT.
```

#set_udp_remote_ip

The #set_udp_remote_ip command sets the remote UDP IP address. The IP address must be specified using dot-decimal notation. The default UDP remote IP address is 192.168.1.255. The switcher must be rebooted after executing this command.

Syntax:

```
#set_udp_remote_ip param1
```

Parameters:

<i>param1</i>	UDP address
---------------	-------------

Example:

```
#set_udp_remote_ip 192.168.1.227
REMOTE UDP IP ADDRESS 192.168.1.227 IS SET.
```

#set_udp_remote_port

The #set_udp_remote_port command sets the remote UDP listening port. The default remote UDP listening port is 50008. The switcher must be rebooted after executing this command.

Syntax:

```
#set_udp_remote_port param1
```

Parameters:

<i>param1</i>	Port	[0 ... 65535]
---------------	------	---------------

Example:

```
#set_udp_remote_port 50008
REMOTE UDP COMMUNICATION PORT 50008 IS SET.
```

#show_hdcp

The #show_hdcp command displays the HDCP status on the specified input.

Syntax:

```
#show_hdcp param1
```

Parameters:

<i>param1</i>	Input	[1 ... 4]
---------------	-------	-----------

Example:

```
#show_hdcp 1  
INPUT 1 HDCP IS ENABLED
```

#show_ir

The #show_ir command displays the IR channel of the switcher.

Syntax:

```
#show_ir
```

Parameters:

None

Example:

```
#show_ir  
CURRENT IR CHANNEL IS: 0
```

#show_out_colordpt

The #show_out_colordpt command displays the highest color depth supported by the specified display based on the EDID. If no display is attached to the specified output, then the command will return NO SIGNAL.

Syntax:

```
#show_out_colordpt
```

Parameters:

None

Example:

```
#show_out_colordpt
OUTPUT HIGHEST COLOR DEPTH IS 8 BITS
```

#show_out_res

The #show_out_res command displays the highest resolution supported by the specified display based on the EDID. If no display is attached to the specified output, then the command will return NO SIGNAL.

Syntax:

```
#show_out_res
```

Parameters:

None

Example:

```
#show_out_res
OUTPUT HIGHEST RESOLUTION IS 1600x900
```

#show_udp_port

The #show_udp_port command displays the current local UDP listening port. Use the #set_udp_port command to set the local UDP listening port.

Syntax:

```
#show_udp_port
```

Parameters:

None

Example:

```
#show_udp_port
```

```
UDP COMMUNICATION PORT IS 56
```

#show_udp_remote_ip

The #show_udp_remote_ip command displays the remote UDP IP address. Use the #set_udp_remote_ip command to set the remote UDP IP address.

Syntax:

```
#set_udp_remote_ip param1
```

Parameters:

None

Example:

```
#set_udp_remote_ip 192.168.1.227
```

```
REMOTE UDP IP ADDRESS IS : 192.168.1.227
```

#show_udp_remote_port

The #show_udp_remote_port command displays the remote UDP listening port. Use the #set_udp_remote_port to set the remote UDP listening port.

Syntax:

```
#set_udp_rport param1
```

Parameters:

None

Example:

```
#show_udp_remote_port
REMOTE UDP COMMUNICATION PORT IS 50008
```

#use_udp_enable

The #use_udp_enable command enables or disables UDP access mode.

Syntax:

```
#use_udp_enable param1
```

Parameters:

param1 Value [0 ... 1]

Value	Description
0	Disable UDP
1	Enable UDP

Example:

```
#use_udp_enable 1
UDP ACCESS IS ENABLED
```

n

The `n` command displays the routing status of the output. Do not precede the `n` command with the `#` symbol. *param1* must be set to 1.

Syntax:

```
n param1
```

Parameters:

<i>param1</i>	Constant	1
---------------	----------	---

Examples:

To see how this command works, we have already selected Input 3 on the switcher. Now, we'll use the `n` command to query the output:

```
n 1
A3
```

The feedback is abbreviated as: "A3". This indicates that Input 3 is the active input.

S

The `s` command routes the specified input to the output. Do not precede this command with the “#” symbol.

Syntax:

```
s param1
```

Parameters:

<i>param1</i>	Input	[1 ... 4]
---------------	-------	-----------

Example:

```
s 2
```

```
INPUT 2 IS ROUTED TO OUTPUT
```

IP / Telnet Configuration

Command	Description
<code>#display_telnet_welcome</code>	Enable / disable the Telnet welcome message
<code>#ipconfig</code>	Displays the current IP configuration
<code>#resetip</code>	Resets the IP configuration to factory-default settings
<code>#set_http_port</code>	Sets the Web server listening port
<code>#set_telnet_pass</code>	Sets the Telnet password
<code>#set_telnet_pass</code>	Sets the Telnet listening port for the switcher
<code>#set_webui_ad_pass</code>	Sets the Administrator password for the Web GUI
<code>#set_webui_op_pass</code>	Sets the Operator password for the Web GUI
<code>#sgateway</code>	Sets the IP address of the (router) gateway
<code>#show_gateway</code>	Displays the current gateway address of the switcher
<code>#show_http_port</code>	Displays the current HTTP listening port of the switcher
<code>#show_ip</code>	Displays the current IP address of the switcher
<code>#show_mac_addr</code>	Displays the MAC address of the switcher
<code>#show_netmask</code>	Displays the current net mask of the switcher
<code>#show_telnet_port</code>	Displays the Telnet listening port
<code>#sipadd</code>	Sets the IP address of the switcher
<code>#snetmask</code>	Sets the Net mask of the switcher
<code>#use_telnet_pass</code>	Force password during Telnet sessions

#display_telnet_welcome

The #display_telnet_welcome command enables / disables the Telnet welcome message during a Telnet session.

Syntax:

```
#display_telnet_welcome
```

Parameters:

param1 Value [0 ... 1]

Value	Description
0	Disable welcome message
1	Enable welcome message

Example:

```
#display_telnet_welcome 1  
TELNET WELCOME SCREEN IS ENABLED
```

When enabled and a Telnet session has been started, the following will appear:

```
Welcome to GTB-HD4K2K-441 TELNET  
telnet->
```

#ipconfig

The #ipconfig command displays the current TCP settings.

Syntax:

```
#ipconfig
```

Parameters:

None

Example:

```
#ipconfig
```

```
IP Configuration is :  
IP: 192.168.2.190  
NETMASK: 255.255.255.0  
GATEWAY: 192.168.1.254
```

#resetip

The #resetip command resets the IP configuration to factory-default settings. The switcher must be rebooted after executing this command.

Syntax:

```
#resetip
```

Parameters:

None

Syntax:

```
#resetip
```

```
IP CONFIGURATION WAS RESET TO FACTORY DEFAULTS  
IP: 192.168.1.72  
Netmask: 255.255.255.0  
Gateway: 192.168.1.1
```

#set_http_port

The `#set_http_port` command specifies the Web server listening port. The switcher must be rebooted after executing this command. The default port setting is 80. Use the `#show_http_port` command to display the current HTTP listening port.

Syntax:

```
#set_http_port param1
```

Parameters:

<i>param1</i>	Port	[1 ... 1024]
---------------	------	--------------

Example:

```
#set_http_port 82
```

```
HTTP COMMUNICATION PORT 82 IS SET. PLEASE REBOOT THE UNIT.
```

#set_telnet_pass

The `#set_telnet_pass` command sets the Telnet password. The password is case-sensitive and cannot exceed 8 characters in length. The default password is Admin.

Syntax:

```
#set_telnet_pass param1
```

Parameters:

<i>param1</i>	Password
---------------	----------

Example:

```
#set_telnet_pass 3ver3st
```

```
TELNET INTERFACE PASSWORD IS SET
```

#set_telnet_port

The `#set_telnet_port` command sets the Telnet listening port. The switcher must be rebooted after executing this command. The default port setting is 23. Use the `#show_telnet_port` command to display the current Telnet listening port.

Syntax:

```
#set_telnet_port param1
```

Parameters:

<i>param1</i>	Port	[1 ... 1024]
---------------	------	--------------

Example:

```
#set_telnet_port 24
```

```
TELNET COMMUNICATION PORT 24 IS SET. PLEASE REBOOT THE UNIT.
```

#set_webui_ad_pass

The `#set_webui_ad_pass` command sets the Administrator password for the Web GUI. The password is case-sensitive and cannot exceed 7 characters in length. The default password is Admin.

Syntax:

```
#set_webui_ad_pass param1
```

Parameters:

<i>param1</i>	Password
---------------	----------

Example:

```
#set_webui_ad_pass bossman
```

```
WEB UI ADMINISTRATOR PASSWORD IS SET
```

#set_webui_op_pass

The #set_webui_ad_pass command sets the Operator password for the Web GUI. The default password is Admin.

Syntax:

```
#set_webui_op_pass param1
```

Parameters:

param1 Password

Example:

```
#set_webui_op_pass minion  
WEB UI OPERATOR PASSWORD IS SET
```

#sgateway

The #sgateway command sets the gateway address. The gateway must be typed using dot-decimal notation. The switcher must be rebooted after executing this command. The default gateway is 192.168.1.1.

Syntax:

```
#sgateway param1
```

Parameters:

param1 Gateway

Example:

```
#sgateway 192.168.1.5  
GATEWAY ADDRESS 192.168.1.5 IS SET. PLEASE REBOOT THE UNIT.
```

#show_gateway

The #show_gateway command displays the current gateway address of the switcher. Use the #sgateway command to set the gateway address.

Syntax:

```
#show_gateway
```

Parameters:

None

Example:

```
#show_gateway
```

```
GATEWAY ADDRESS IS: 192.168.1.5
```

#show_http_port

The #show_http_port command displays the current HTTP listening port of the switcher. Use the #set_http_port command to set the HTTP listening port.

Syntax:

```
#show_http_port
```

Parameters:

None

Example:

```
#show_http_port
```

```
HTTP COMMUNICATION PORT IS: 82
```

#show_ip

The #show_ip command displays the current IP address of the switcher. Use the #sipadd command to set the IP address.

Syntax:

```
#show_ip
```

Parameters:

None

Example:

```
#show_ip
```

```
IP ADDRESS IS: 192.168.1.239
```

#show_mac_addr

The #show_mac_addr command displays the MAC address of the switcher.

Syntax:

```
#show_mac_addr
```

Parameters:

None

Example:

```
#show_mac_addr
```

```
MAC ADDRESS IS: 00-1c-91-03-00-02
```

#show_netmask

The #show_netmask command displays the current net mask of the switcher. Use the #snetmask command to set the net mask.

Syntax:

```
#show_netmask
```

Parameters:

None

Example:

```
#show_netmask
```

```
NETMASK ADDRESS IS: 255.255.255.0
```

#show_telnet_port

The #show_telnet_port command displays the current Telnet port of the switcher. Use the #set_telnet_port command to set the Telnet listening port.

Syntax:

```
#set_telnet_port param1
```

Parameters:

<i>param1</i>	Port	[1 ... 65535]
---------------	------	---------------

Example:

```
#set_telnet_port 24
```

```
TELNET COMMUNICATION PORT 24 IS SET. PLEASE REBOOT THE UNIT.
```

#show_telnet_username

The #show_telnet_username command displays the user name of the current Telnet session.

Syntax:

```
#show_telnet_username
```

Parameters:

None

Example:

```
#show_telnet_username
USER NAME FOR TELNET IS : Admin
```

#show_ver_data

The #show_ver_data command displays the current software and hardware version.

Syntax:

```
#show_ver_data
```

Parameters:

None

Example:

```
#show_ver_data
SOFTWARE AND HARDWARE VERSION : v0.7U PCB-1979*B
```

#sipadd

The #sipadd command sets the IP address of the switcher. The IP address must be entered using dot-decimal notation. The switcher must be rebooted after executing this command. The default IP address is 192.168.1.72. Use the #show_ip or #ipconfig command to display the current IP address of the switcher.

Syntax:

```
#sipadd param1
```

Parameters:

param1 IP address

Example:

```
#sipadd 192.168.2.190
IP ADDRESS 192.168.2.190 IS SET.
```

#snetmask

The #snetmask command sets the subnet mask. The net mask must be entered using dot-decimal notation. The switcher must be rebooted after executing this command. The default net mask is 255.255.255.0. Use the #show_netmask or #ipconfig command to display the current net mask of the switcher.

Syntax:

```
#snetmask param1
```

Parameters:

param1 Net mask

Example:

```
#snetmask 255.255.0.0
NETMASK ADDRESS 255.255.0.0 IS SET. PLEASE REBOOT THE UNIT.
```

#use_telnet_pass

The #use_telnet_pass command forces the password credentials for each Telnet session. The default setting is 0 (disabled). Use the #set_telnet_pass command to set the Telnet password.

Syntax:

```
#use_telnet_pass param1
```

Parameters:

param1 Value [0 ... 1]

Value	Description
0	Disable password
1	Enable password

Example:

```
#use_telnet_pass 1
```

```
TELNET INTERFACE PASSWORD IS ENABLED
```

Masking

Command	Description
<code>#mask</code>	Masks the video on the specified output(s)
<code>#show_mask</code>	Displays the current masking status of each output
<code>#unmask</code>	Unmasks the specified outputs

#mask

The `#mask` command masks the video on the output. Use the `#unmask` command to disable output masking.

Syntax:

```
#mask
```

Parameters:

None

Example:

```
#mask
```

```
OUTPUT IS MASKED
```

#unmask

The `#unmask` command unmask the output. Use the `#mask` command to mask the output.

Syntax:

```
#unmask
```

Parameters:

None

Example:

```
#unmask
```

```
OUTPUT IS UNMASKED
```

#show_mask

The `#show_mask` command displays the mask status of the output.

Syntax:

```
#show_mask
```

Parameters:

None

Example:

```
#show_mask
```

```
OUTPUT(OUTPUT1) IS UNMASKED
```

Routing / Naming / +5V / Presets

Command	Description
#lock_switcher	Locks / unlocks the switcher
#set_bank_name	Assigns an EDID bank with the specified name
#set_input_name	Assigns an input with the specified name
#set_output_name	Assigns the output with the specified name
#show_bank_name	Displays the name for the specified EDID bank
#show_input_name	Displays the name of the specified input
#show_output_name	Displays the name of the output
#show_r	Displays the routing status of the output
r	Routes the specified input to the output

#lock_switcher

The #lock_switcher command locks / unlocks the switcher. When the switcher is locked, all functions are disabled including the front panel, RS-232, and Telnet.

Syntax:

```
#lock_switcher param1
```

Parameters:

param1 Value [0 ... 1]

Value	Description
0	Unlock
1	Lock

Example:

```
#lock_switcher 1  
SWITCHER IS UNLOCKED
```

#set_bank_name

The #set_bank_name command names the specified bank.

Syntax:

```
#set_bank_name param1 param2
```

Parameters:

<i>param1</i>	Bank	[1 ... 8]
<i>param2</i>	Name	

Example:

```
#set_bank_name 5 Dell_24
```

```
Dell_24 NAME IS ASSIGNED TO BANK 5
```

#set_input_name

The #set_input_name command assigns a name to the specified input on the switcher.

Syntax:

```
#set_input_name param1 param2
```

Parameters:

<i>param1</i>	Input	[1 ... 4]
<i>param2</i>	Name	

Example:

```
#set_input_name 3 Blu-ray
```

```
Blu-ray NAME IS ASSIGNED TO INPUT 3
```

#set_output_name

The #set_output_name command assigns a name to the output on the switcher. The name of the output cannot exceed 15 characters in length. Names longer than 15 characters will be truncated. To name an output, use the #set_output_name command.

Syntax:

```
#set_output_name param1
```

Parameters:

<i>param1</i>	Name	[STRING]
---------------	------	----------

Example:

```
#set_output_name 3 Sony_XBR  
Sony_XBR NAME IS ASSIGNED TO OUTPUT
```

#show_bank_name

The #show_bank_name command displays the name for the specified EDID bank. To name an EDID bank, use the #set_bank_name command.

Syntax:

```
#show_bank_name param1
```

Parameters:

<i>param1</i>	Bank	[1 ... 8]
---------------	------	-----------

Example:

```
#show_bank_name 5  
THE NAME FOR BANK 5 IS : Dell_24
```

#show_input_name

The #show_input_name command displays the name of the specified input. To name an input, use the #set_input_name command.

Syntax:

```
#show_input_name param1
```

Parameters:

<i>param1</i>	Input	[1 ... 4]
---------------	-------	-----------

Example:

```
#show_input_name 3
```

```
THE NAME FOR INPUT 3 IS : Blu-ray
```

#show_output_name

The #show_output_name command displays the name of the output. To name an output, use the #set_output_name command.

Syntax:

```
#show_output_name
```

Parameters:

None

Example:

```
#show_output_name
```

```
THE NAME FOR OUTPUT IS : Sony_XBR
```

#show_r

The #show_r command displays the current routing status of the output. The name of the output and input are displayed.

Syntax:

```
#show_r
```

Parameters:

None

Example:

```
#show_r
```

```
OUTPUT (Sony_XBR) IS ROUTED TO INPUT 1 (INPUT1)
```

r

The r command routes the specified input to the output. Do not precede this command with the “#” symbol. Also see the s command.

Syntax:

```
r param1
```

Parameters:

<i>param1</i>	Input	[1 ... 4]
---------------	-------	-----------

Example:

```
r 3
```

```
INPUT 3 IS ROUTED TO OUTPUT
```

Status

Command	Description
<code>#help</code>	Displays a list of available RS-232 / Telnet commands
<code>#show_fw</code>	Displays the current version of firmware
<code>#show_hpd</code>	Displays the HPD status of the specified input
<code>#show_rsense</code>	Displays the RSENSE status of the output
<code>m</code>	Displays the current routing status of the switcher

#help

The `#help` command displays the list of available RS-232 / Telnet commands. Help on a specific command can be displayed when using `param1`.

Syntax:

```
#help param1
```

Parameters:

`param1` Command name (optional)

Example:

```
#help #sipadd  
  
#SIPADD PARAM 1  
SET THE IP ADDRESS  
PARAM 1 = XXX.XXX.XXX.XXX  
WHERE XXX: 0 - 255
```

#show_fw

The #show_fw command displays the current version of switcher firmware.

Syntax:

```
#show_fw
```

Parameters:

None

Example:

```
#show_fw
```

```
FIRMWARE VERSION = GTB-HD4K2K-441 v0.7U
```

#show_hpd

The #show_hpd command displays the HPD status of the specified output. The name of the output is included.

Syntax:

```
#show_hpd
```

Parameters:

None

Example:

```
#show_hpd
```

```
HPD OF OUTPUT (Sony_XBR) IS HIGH
```

#show_rsense

The #show_rsense command displays the RSENSE status of the output. The name of the output is included.

Syntax:

```
#show_rsense
```

Parameters:

None

Example:

```
#show_rsense
```

```
RSENSE OF OUTPUT 6 (Output6) IS HIGH
```

m

The `m` command displays the current routing status of the switcher. Do not precede the `m` command with the “#” symbol.

Syntax:

```
m
```

Parameters:

None

Example:

```
m
```

```
Out : 1  
In  : 2
```

```
OUTPUT 1 IS UNMASKED  
SWITCHER IS UNLOCKED
```

Web Interface

Using the built-in Web Server

Access the built-in Web interface by entering the IP address of the switcher that was specified in step 3 under [IP / UDP Configuration](#). Once connected to the switcher, the login screen will be displayed.

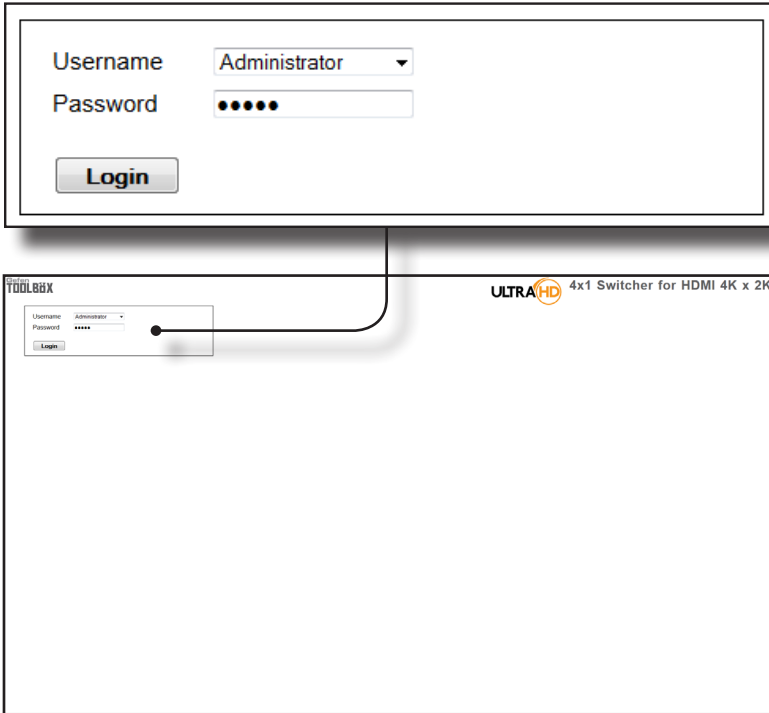

Username

Select the username from the drop-down list.

Options:

Operator, Administrator

Administrator login provides unrestricted access to all features and settings. Operator login limits access to switcher routing, display information, and routing preset features.

Password

Enter the password for the associated username. The password can also be set using RS-232 or Telnet. See the `#set_webui_op_pass` and the `#set_webui_ad_pass` commands. The password is masked when it is entered.

The Web GUI is divided into four main pages: **Main**, **I/O Setup**, **Manage EDID**, and **Configuration**. Each main page is represented by a tab at the top-most portion of the screen. The **Main**, **I/O Setup**, and **Manage EDID** pages have their own set of sub-tabs. Click on the desired tab / sub-tab to open the desired page.



NOTE: In order to view all four tabs at the top of the screen, the user must be logged in as “Administrator”. If logged-in as “Operator”, only the **Main** tab will be visible.

Main ► Routing

Log Out

Click **Log Out** to terminate the current Web session and return to the login page.

Log Out

The screenshot shows the TOOLBOX web interface for a 4x1 HDMI switcher. The top navigation bar includes tabs for Main, I/O Setup, Manage EDID, and Configuration. The current page is 'Routing', with sub-tabs for I/O Status and Display Info. The main content area features a 'Look Up/Down' button and three tables: 'Status', 'Outputs', and 'Inputs'. The 'Status' table shows the current routing configuration. A callout box labeled 'Log Out' points to the 'Log Out' button in the top right corner of the interface. Below the screenshot, a zoomed-in view of the 'Status' table is provided.

Status	
Output	Input #
1	1

Output

The number of outputs that are available for routing. Since this is a 4x1 switcher, only one output is available.

Input

The input that is currently routed to the output.

The screenshot shows the web interface for the ULTRA HD 4x1 Switcher. The 'Routing' tab is active, showing 'I/O Status' and 'Display Info'. A 'Look Switcher' button is present. The main area displays a routing configuration with two tables: 'Outputs' and 'Inputs'. The 'Outputs' table has columns 'Name' and 'Output'. The 'Inputs' table has columns 'Input #' and 'Name'. A 'Route' button is located below the 'Inputs' table. A line connects the 'Output' column of the 'Outputs' table to the 'Input #' column of the 'Inputs' table.

Outputs	
Name	Output
OUTPUT1	<input checked="" type="checkbox"/>

Inputs	
Input #	Name
<input checked="" type="radio"/> 1	INPUT1
<input type="radio"/> 2	INPUT2
<input type="radio"/> 3	INPUT3
<input type="radio"/> 4	INPUT4
Mask / Unmask	

Route

Name (Outputs)

The name of the output.

This name can be changed using the `#set_output_name` command or through the I/O Setup ► I/O Names page of the Web interface.

Output

Check to select the currently active output. Since only one output is available, this output is always checked.

Input # (Inputs)

Click the radio button next to the desired input to be routed. Only one input can be selected at a time.

Name (Inputs)

Displays the current name of the input.

Route

Click the **Route** button to route the selected input to the select output(s).

Lock Switcher

Locks / unlocks the switcher. Once the switcher is locked, settings cannot be changed using the front-panel buttons or through the Web GUI. When the switcher is locked, the button text will read “Unlock Switcher” and a red bar will appear across the top portion of the screen with the text “Switcher is LOCKED”. Click the “Unlock Switcher” button to unlock the switcher.

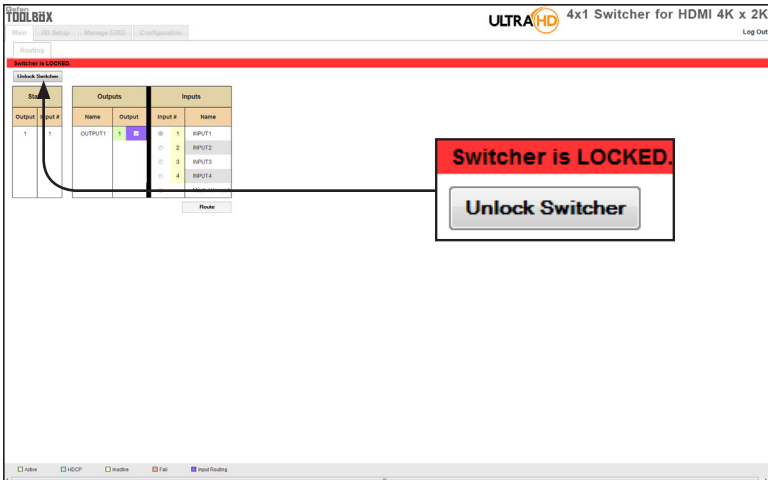
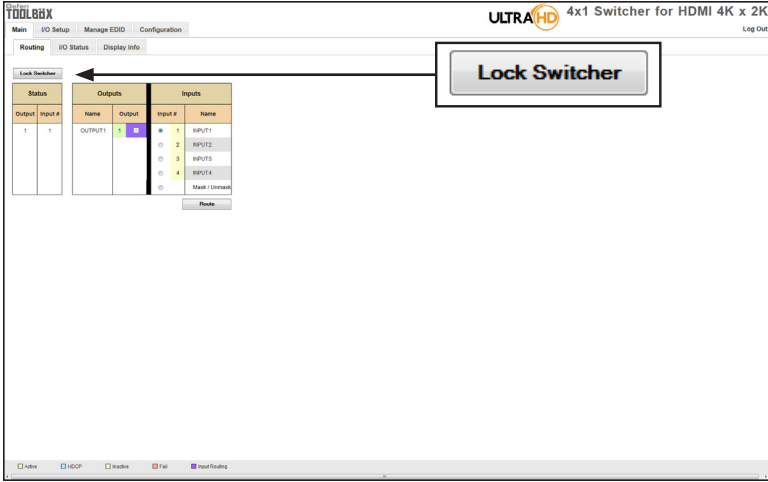

Main ► I/O Status

The screenshot shows the TDBOX web interface for an ULTRAHD 4x1 Switcher for HDMI 4K x 2K. The 'I/O Status' page is active, displaying a table for 'Output 1' and a detailed view of its settings.

Output				
	1	2	3	4
Name	OUTPUT1			
RSENSE	On			
Mask	Off			
HPD	High			
HDCP	Inactive			
Video Mode	DVI			

Input				
	1	2	3	4
Name	INPUT1	INPUT2	INPUT3	INPUT4
Color Depth	-	-	RGB	-
Color Space	-	-	RGB	-
HDCP	NO	NO	NO	NO
ID	-	-	NO	-
Serial Input	NO	NO	YES	NO
Vertical Sync	-	-	750	-
Horizontal Sync	-	-	1300	-
Progressive / Interlaced	-	-	p	-
Refresh Rate	-	-	-	-
Video Mode	DVI	DVI	DVI	DVI

Output	
	1
Name	OUTPUT1
RSENSE	On
Mask	Off
HPD	High
HDCP	Inactive
Video Mode	DVI

Output

Displays the state of each output for each of the following: Name, RSENSE, Mask, HPD (Hot-Plug Detect), HDCP, and Video Mode.

Name

Displays the name of the output. The name of the output can be changed using the `#set_output_name` command or through the [I/O Setup ► I/O Names](#) page of the Web interface.

RSENSE

Displays the current Rsense state.

Mask

Displays the masking state of each output.

HPD

Displays the Hot-Plug Detect (HPD) state of each output.

HDCP

Indicates if HDCP-detection is enabled or disabled on each output.

Video Mode

Displays the current output video mode.

TOOLBOX
4x1 Switcher for HDMI 4K x 2K

Main | IO Setup | Manage EDD | Configuration
ULTRA HD
Log Out

Routing
IO Status
Display Info

Output				
	1	2	3	4
Name	OUTPUT1			
SEND	On			
Link	Off			
EDID	High			
HDCP	Inactive			
Video Mode	DVI			

Input				
	1	2	3	4
Name	INPUT1	INPUT2	INPUT3	INPUT4
Color Depth	-	8bit		
Color Space	-	RGB		
HDCP	No	No	No	No
3D	-	Yes		
Active Signal	No	No	Yes	No
Vertical Resolution	-	720		
Horizontal Resolution	-	1280		
Progressive / Interlaced	-	-	p	
Refresh Rate	-	-	-	
Video Mode	DVI	DVI	DVI	DVI

Input				
	1	2	3	4
Name	INPUT1	INPUT2	INPUT3	INPUT4
Color Depth	-	-	8bit	-
Color Space	-	-	RGB	-
HDCP	No	No	No	No
3D	-	-	No	-
Active Signal	No	No	Yes	No
Vertical Resolution	-	-	720	-
Horizontal Resolution	-	-	1280	-
Progressive / Interlaced	-	-	p	-
Refresh Rate	-	-	-	-
Video Mode	DVI	DVI	DVI	DVI

Input

Displays the state of each input for each of the following: Input name, Color Depth, Color Space, HDCP, 3D, Active Signal, Vertical Resolution, Horizontal Resolution, Progressive / Interlaced, Refresh Rate, and Video Mode.

Main ► Display Info

Choose EDID 1 - BANK1 ▼

ULTRA HD 4x1 Switcher for HDMI 4K x 2K

TOOLBOX

Main I/O Setup Manage EDID Configuration

Routing I/O Status **Display Info**

Choose EDID 1 - BANK1 ▼

Feature	
24Hz Frame Rate	TRUE
Max Resolution	1080p@60Hz
Max Color Depth	8 bit
3D Capable	FALSE
Mode (DVI/HDMI)	HDMI
Max Audio Channels	2 Ch
Monitor Name	HDMI-DA

Audio Formats	
LPCM	TRUE
DTS-HD	FALSE
DTS Digital Surround	FALSE
Dolby Digital (AC3)	FALSE
Dolby TrueHD	FALSE

Feature	
24Hz Frame Rate	TRUE
Max Resolution	1080p@60Hz
Max Color Depth	8 bit
3D Capable	FALSE
Mode (DVI/HDMI)	HDMI
Max Audio Channels	2 Ch
Monitor Name	HDMI-DA

Audio Formats	
LPCM	TRUE
DTS-HD	FALSE
DTS Digital Surround	FALSE
Dolby Digital (AC3)	FALSE
Dolby TrueHD	FALSE

Choose EDID

Select the EDID from the drop-down list. The selected EDID will be copied from the Output or selected EDID Bank to the desired input(s) and used by the source.

Options
Default EDID
Bank 1 ... Bank 8
Output 1

Feature / Audio Formats

Displays the capabilities of the display (or sink device), based on the EDID.

I/O Setup ► I/O Names



Edit Output & Input Names			
Output	Name	Input #	Name
1	<input type="text" value="OUTPUT1"/>	1	<input type="text" value="INPUT1"/>
		2	<input type="text" value="INPUT2"/>
		3	<input type="text" value="INPUT3"/>
		4	<input type="text" value="INPUT4"/>

Output

The number of the output.

Input #

The number of each input.

Name

Type the desired name of the output and/or input(s) in these fields.

Save Changes

Saves the current changes to the name of the output and/or input(s).

Cancel

Restores the previous name or each output and/or input(s), if a change was made.

I/O Setup ► HPD Control

HPD Control		
Input #	Name	
1	INPUT1	Pulse
2	INPUT2	Pulse
3	INPUT3	Pulse
4	INPUT4	Pulse

Input #

The number of the input.

Name

The name of the input. The name of each input can be changed using the `#set_input_name` command or through the [I/O Setup ► I/O Names](#) page of the Web interface.

Pulse

Click the Pulse button to cycle the HPD line on the desired input. This is the equivalent of physically disconnecting and reconnecting the HDMI cable between the source device and the switcher.

I/O Setup ► HDCP



NOTE: Some computers will enable HDCP if an HDCP-compliant display is detected. Check the box under the Disable column to force the computer to ignore detection of an HDCP-compliant display. The Disable feature does *not* decrypt HDCP content.

Disable	Input #	Name
<input type="checkbox"/>	1	INPUT1
<input type="checkbox"/>	2	INPUT2
<input type="checkbox"/>	3	INPUT3
<input type="checkbox"/>	4	INPUT4

Buttons: Check All, Clear All, Set, Cancel

Disable

Check the box under the Disable column to force the computer to ignore HDCP-detection.

Input #

The number of the input.

Name

The name of the input. The name of each input can be changed using the [#set_input_name](#) command or through the [I/O Setup ► I/O Names](#) page of the Web interface.

Check All

Places a check mark in all boxes under the Disable column.

Clear All

Clears all check marks from the Disable column.

Set

Click this button to save changes for all input(s).

Cancel

Cancels the current operation and ignores changes for each input, if a change was made.

Manage EDID ▶ Assign

Lock EDID

Secures the Local EDID and disables automatic EDID loading during power-up.

If the **Lock EDID** button is clicked (enabled), the “EDID locked on power cycle” message will be displayed in red. The local EDID information will now be locked once the switcher is rebooted. Click the **Unlock EDID** button to disable the Lock EDID feature.

The screenshot shows the 'Assign' page in the web interface. At the top, there are buttons for 'Lock EDID' and 'Unlock EDID'. A red banner displays the message 'EDID locked on power cycle.'. Below this, the 'Assign' page is visible, featuring a 'Copy EDID From' dropdown menu set to '1 - BANK1'. The page contains two tables for selecting source and destination EDID information.

Copy To	EDID Source	Input #	Name	EDID Source	EDID Name
<input type="checkbox"/>	External-Output	1	INPUT1	Ed EDID(OUT1)	DELL E2010H
<input type="checkbox"/>	External-Output	2	INPUT2	Ed EDID(OUT1)	DELL E2010H
<input type="checkbox"/>	External-Output	3	INPUT3	Ed EDID(OUT1)	DELL E2010H
<input type="checkbox"/>	External-Output	4	INPUT4	Ed EDID(OUT1)	DELL E2010H

Copy To	Input #	Name	Bank #	EDID Name
<input type="checkbox"/>	1	BANK1	0716-01-A	
<input type="checkbox"/>	2	BANK2	UNDEFINE	
<input type="checkbox"/>	3	BANK3	SEC0754	
<input type="checkbox"/>	4	BANK4	UNDEFINE	
<input type="checkbox"/>	5	BANK5	UNDEFINE	
<input type="checkbox"/>	6	BANK6	UNDEFINE	
<input type="checkbox"/>	7	BANK7	POS8-0A	
<input type="checkbox"/>	8	BANK8	0716-01-A	

Copy EDID From

Select the EDID from the drop-down list. The EDID will be copied from the Output or selected EDID bank to the destination

Options
Bank 1 ... Bank 8
Output 1

Inputs					
Copy To	EDID Modes	Input #	Name	EDID Source	EDID Name
<input type="checkbox"/>	External - Output1	1	INPUT1	Ext EDID(OUT1)	DELL E2010H
<input type="checkbox"/>	External - Output1	2	INPUT2	Ext EDID(OUT1)	DELL E2010H
<input type="checkbox"/>	External - Output1	3	INPUT3	Ext EDID(OUT1)	DELL E2010H
<input type="checkbox"/>	External - Output1	4	INPUT4	Ext EDID(OUT1)	DELL E2010H

Copy EDID From: [Blank] ▾

Copy EDID To: Please select from the Inputs/Banks below

Copy To	EDID Modes	Input #	Name	EDID Source	EDID Name
<input type="checkbox"/>	External - Output1	1	INPUT1	Ext EDID(OUT1)	DELL E2010H
<input type="checkbox"/>	External - Output1	2	INPUT2	Ext EDID(OUT1)	DELL E2010H
<input type="checkbox"/>	External - Output1	3	INPUT3	Ext EDID(OUT1)	DELL E2010H
<input type="checkbox"/>	External - Output1	4	INPUT4	Ext EDID(OUT1)	DELL E2010H

Copy To	Input #	Name	EDID Name
<input type="checkbox"/>	1	BANK1	DT16-03.x
<input type="checkbox"/>	2	BANK2	UKOFFINE
<input type="checkbox"/>	3	BANK3	SE20074
<input type="checkbox"/>	4	BANK4	UKOFFINE
<input type="checkbox"/>	5	BANK5	UKOFFINE
<input type="checkbox"/>	6	BANK6	UKOFFINE
<input type="checkbox"/>	7	BANK7	PHISICAL
<input type="checkbox"/>	8	BANK8	DT16-03.x

Copy To

Place a check mark in the desired check box to select or deselect the desired input(s). These check-boxes can only be used when the EDID Mode is set to Custom - User.

EDID Modes

Select the EDID mode from the drop-down list.

Options
Internal - 1080p 2 ch audio
Internal - 1080p Multi ch
External - Output1
Custom - Last Output*
Custom - User

*Since this is a 4x1 switcher, only one output is available.

(continued on next page)

Inputs					
Copy To	EDID Modes	Input #	Name	EDID Source	EDID Name
<input type="checkbox"/>	External - Output1	1	INPUT1	Ext EDID(OUT1)	DELL E2010H
<input type="checkbox"/>	External - Output1	2	INPUT2	Ext EDID(OUT1)	DELL E2010H
<input type="checkbox"/>	External - Output1	3	INPUT3	Ext EDID(OUT1)	DELL E2010H
<input type="checkbox"/>	External - Output1	4	INPUT4	Ext EDID(OUT1)	DELL E2010H

Input #

The number of the input.

Name

The name of the input. The name of the input can be changed using the `#set_input_name` command or through the [I/O Setup ► I/O Names](#) page of the Web interface.

EDID Source

The current EDID source being used.

EDID Name

The name of the EDID.

Clear All

Clears all check marks from the **Copy To** column.

Manage EDID ► Bank Names

The screenshot shows the 'Edit Banks Names' dialog box. The dialog has a title bar 'Edit Banks Names' and a table with two columns: 'Bank #' and 'Name'. The table contains 8 rows, each with a bank number and a text input field containing the name 'BANK1' through 'BANK8'. Below the table are two buttons: 'Save Changes' and 'Cancel'. A callout line points from the 'Name' field of Bank #2 in the background table to the 'Name' field of Bank #2 in the dialog box.

Bank #	Name
1	BANK1
2	BANK2
3	BANK3
4	BANK4
5	BANK5
6	BANK6
7	BANK7
8	BANK8

Bank

Indicates the EDID bank number.

Name

Type the desired name of the EDID bank in this field.

Save Changes

Saves the current name change to the EDID bank(s).

Cancel

Restores the previous names for each EDID bank, if a change was made.

Manage EDID ► Upload/Download

Browse...

Click this button to select the EDID file to be uploaded.

Select Bank Location

Click this drop-down list to select the bank to where the EDID will be uploaded.

Options
1 - Bank1 ... 8 - Bank8

Upload

Click this button to upload the EDID to the specified bank.

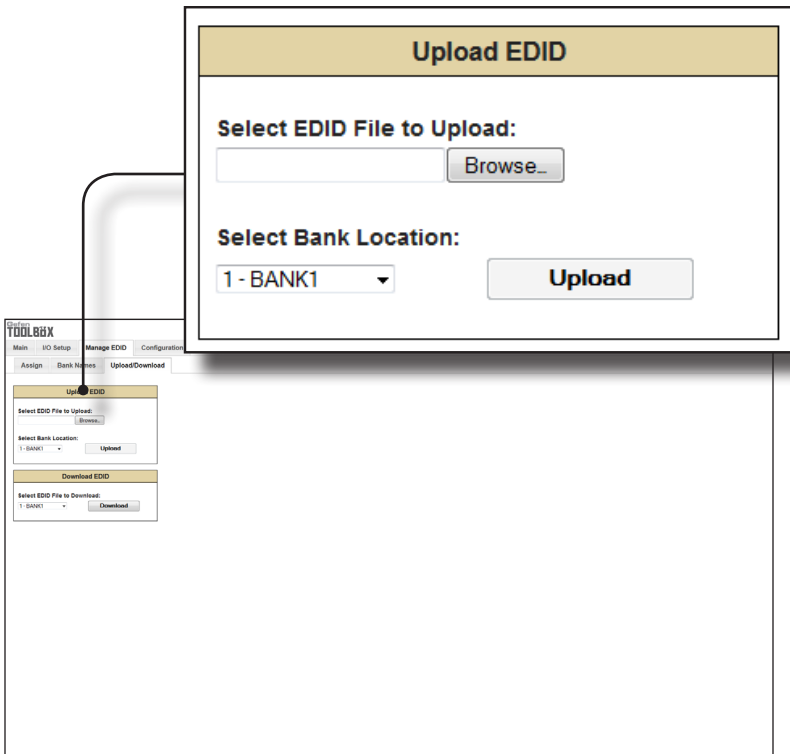

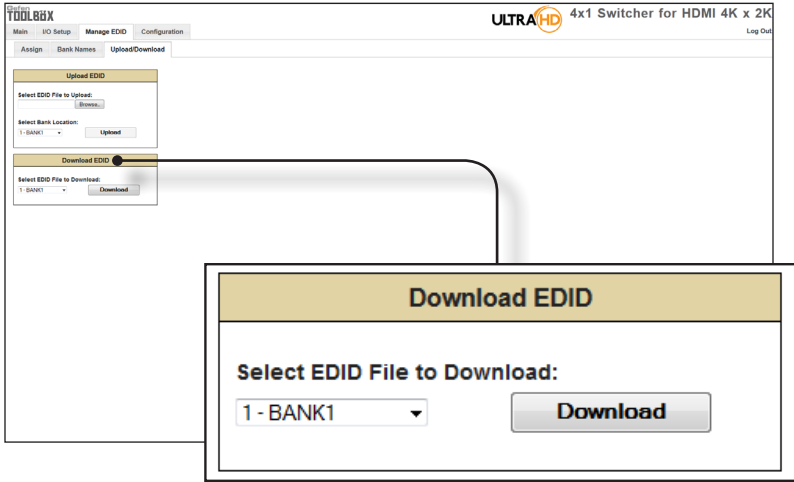

Select EDID File to Download

Click this box to select the EDID that is to be saved to a file. The EDID file will be saved in binary (.bin) format.

Options	
1 - BANK1 ... 8 - BANK8	
1 - OUTPUT1	
1 - INPUT1 ... 4 - INPUT4	

Download

Click this button to download the selected EDID to a file.

Configuration ► Change IP Settings

The screenshot shows the 'Change IP Settings' page in the web interface. The page title is 'Change IP Settings'. The form contains the following fields and values:

Field	Value
MAC Address:	00:1c:91:03:3f:ff
IP Address:	192.168.2.190
Subnet:	255.255.255.0
Gateway:	192.168.1.254
Port:	80
TCP/Telnet Terminal Port:	23
UDP Port:	50007

At the bottom of the form, there are two buttons: 'Save Settings' and 'Set Defaults'.

Change IP Settings

Assigns the IP address, subnet, gateway, HTTP listening port, Telnet port, and UDP port. The MAC address cannot be changed.

Save Settings

Saves the current settings for the Change IP Settings. After clicking this button, the Web interface will display a dialog indicating that the switcher must be rebooted for changes to take effect.

Set Defaults

Click this button to restore the factory-default IP settings. After clicking this button, the Web interface will display a dialog indicating that the switcher must be rebooted for changes to take effect.

Configuration ► Telnet Login Settings

The screenshot shows the 'Telnet Login Settings' configuration page in a web interface. The page is titled 'Telnet Login Settings' and contains the following fields and options:

- Old Password:** A text input field with a masked password (•••••).
- New Password:** A text input field.
- Confirm New Password:** A text input field.
- Force Password on Connect:** A checked checkbox.
- Show Login Message on Connect:** A checked checkbox.

A **Save Settings** button is located at the bottom right of the page.

Old Password

Type the current (old) password in this field.

New Password

Type the new password in this field.

Force Password on Connect

Click this check box to have the switcher prompt for a password each time a Telnet session is started. This box *must* be checked in order to change the Telnet Login credentials.

Show Login Message on Connect

Click this check box to have the switcher display the Telnet welcome message each time a Telnet session is started. The welcome message appears as: "Welcome to GTB-HD4K2K-441 TELNET".

Save Settings

Saves the current changes to the Telnet Login Settings.

Configuration ► UDP Connection Settings

The screenshot shows the configuration page for the ULTRA HD 4x1 Switcher for HDMI 4K x 2K. The 'UDP Connection Settings' section is highlighted with a callout box. The settings are as follows:

Setting	Value
Remote UDP IP Address	192.168.1.80
Remote UDP Port	50010
Enable UDP Access	<input checked="" type="checkbox"/>

A 'Save Settings' button is located at the bottom right of the callout box.

Remote UDP IP Address

Type the remote UDP IP address in this text box.

Remote UDP Port

Enter the remote UDP port in this text box.

Enable UDP Access

Check this box to enable UDP access. If this box is unchecked, the UDP access will be unavailable.

Configuration ► Web Login Settings

Web Login Settings

Username: Operator

Old Password: ●●●●

New Password:

Confirm New Password:

Save Settings

Web Login Settings

Old Password: ●●●●

New Password:

Confirm New Password:

Force Password on Connect:

Show Login Message on Connect:

Save Settings

UDP Connection Settings

Remote UDP IP Address: 192.168.1.80

Remote UDP Port: 8000

Enable UDP Access:

Save Settings

System Configuration

Download Current Configuration: **Download**

Revoke Configuration: **Revoke**

Warning: All current settings will be lost. **Revoke**

Firmware Update (S1 ver: v0.7U): **Update**

IR Channel: **Save**

Factory Reset: **Reset**

Reboot: **Reboot**

Username

Click this drop-down list to select the username to be changed.

Old Password

Type the current (old) password in this field.

New Password

Type the new password in this field.

Confirm Password

Re-type the new password in this field.

Save Settings

Saves the current changes to the Web Login Settings.

Configuration ► System Configuration

System Configuration

Download Current Configuration
Download

Restore Configuration

Browse...

Warning: All current settings will be lost

Restore

Firmware Update (UI ver: v0.7U)

Browse...

Update

IR Channel 0 ▼

Save

Factory Reset

Reset

Telnet Login Settings

Old Password:

New Password:

Confirm New Password:

Enter Password on Connect:

Show Login Message on Connect:

Save Settings

UDP Connection Settings

Remote UDP IP Address:

Remote UDP Port:

Enable UDP Access:

Save Settings

Web Login Settings

Username:

Old Password:

New Password:

Confirm New Password:

Save Settings

System Configuration

Download Current Configuration Download

Restore Configuration Browse...

Warning: All current settings will be lost

Restore

Firmware Update (UI ver: v0.7U) Update

Save

IR Channel: 0 ▼ Save

Factory Reset Reset

Factory Reset Reset

Reboot Reboot

Download

Click this button to download the current switcher configuration to a file.

(continued on next page)

System Configuration

Download Current Configuration

Restore Configuration

Warning: All current settings will be lost

Firmware Update (UI ver: v0.7U)

IR Channel 0

Factory Reset

Reboot

Browse

Click this button to select the firmware file to be uploaded. See [Upgrading using the Web interface](#) for details on updating the firmware.

Browse

Click this button to select the saved configuration file to be loaded into memory.

Restore

Uploads the selected configuration file to the switcher.

Update

Updates the switcher with the selected firmware file.

page | 79

System Configuration

Download Current Configuration

Restore Configuration

Warning: All current settings will be lost

Firmware Update (UI ver: v0.7U)

IR Channel 0

Factory Reset

Reboot

IR Channel

Click this drop-down list to set the desired IR channel for the switcher. Note that the switcher and the included IR remote control must be set to the same channel in order to work properly. The IR channel for the switcher can also be set using the `#set_ir` command.

Options

0 ... 3

Save

Click this button to save any changes made to the IR channel setting.

Reset

Click this button to set the switcher to factory-default settings. The IP settings are preserved.

Reboot

Click this button to reboot the switcher.

ULTRA HD

4x1
SOURCES DISPLAY

**Switcher for HDMI
with Ultra HD
4K x 2K support**

04 Appendix

Wall Mounting Instructions	84
Firmware Upgrade Procedure	85
Specifications	86

Wall Mounting Instructions

The 4x1 Switcher for HDMI 4K x 2K should be mounted vertically in a wall or cabinet with wood/drywall screws as shown in the diagram above. There should be an inch or two of clearance between the edges of the unit and any walls or vertical surfaces to allow for enough clearance for insertion and retraction of cables at the HDMI connectors.

For installation on a drywall surface, use a #6 drywall screw. It is recommended when installing on a drywall surface that studs be used to secure the switcher should undue stress be applied when connecting and disconnecting HDMI cables.

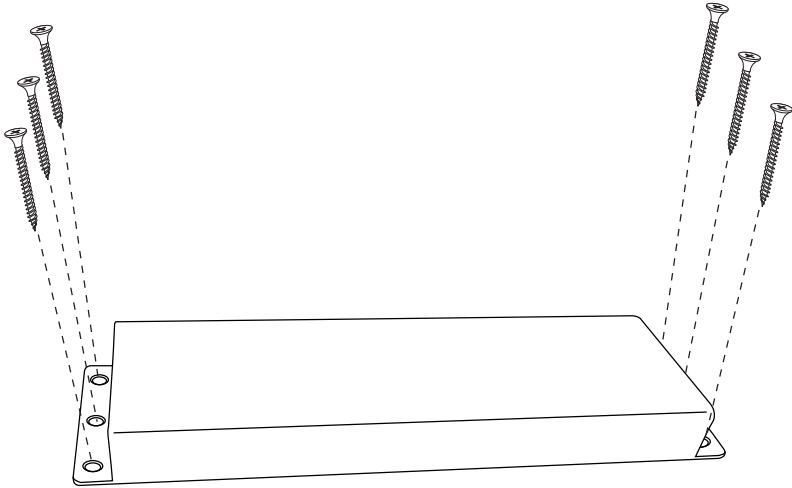

Firmware Upgrade Procedure

The following items are required to update firmware:

- GefenToolBox 4x1 Switcher for HDMI 4K x 2K
- Computer (Mac or PC)
- USB-to-Mini-USB cable
- Firmware file

1. Download the firmware from the Gefen Web site.
2. Extract the firmware file from the .ZIP file.

It is unnecessary to disconnect any HDMI cables from the switcher during the update process.

3. Connect the USB cable between the computer and the 4x1 Switcher for HDMI 4K x 2K.
4. Power-ON the 4x1 Switcher for HDMI 4K x 2K.
5. Once the computer is able to connect to the 4x1 Switcher for HDMI 4K x 2K, a removable disk icon will be displayed.
6. Drag the .bin file to the removable disk.
7. Wait for the file to be copied to the removable disk.
8. After the file has been copied, disconnect the USB cable from the switcher.
9. The switcher will begin updating the firmware.
10. Once the firmware update has completed, the 4x1 Switcher for HDMI 4K x 2K will automatically reboot.

Specifications

Supported Formats	
Resolutions (max.)	<ul style="list-style-type: none"> • Ultra HD 4K x 2K (3840 x 2160 @ 30 Hz) • 1080p Full HD
Audio	<ul style="list-style-type: none"> • LPCM 7.1 • Dolby® TrueHD • DTS-HD Master Audio™

Electrical	
Maximum Pixel Clock	<ul style="list-style-type: none"> • 300 MHz
Power Indicator	<ul style="list-style-type: none"> • 1 x LED, blue
Input Indicators	<ul style="list-style-type: none"> • 4 x LED, green
Input Switch	<ul style="list-style-type: none"> • 1 x Tact-type

Connectors	
Video Input	<ul style="list-style-type: none"> • 4 x HDMI, Type A 19-pin, female, locking
Video Output	<ul style="list-style-type: none"> • 1 x HDMI, Type A 19-pin, female, locking
USB	<ul style="list-style-type: none"> • Mini-B
Power	<ul style="list-style-type: none"> • Locking-type
RS-232	<ul style="list-style-type: none"> • 1 x DB-9, female
Ethernet	<ul style="list-style-type: none"> • 1 x RJ-45
IR Extender	<ul style="list-style-type: none"> • 1 x 3.5mm mini-stereo

Operational	
Power Input	<ul style="list-style-type: none"> • 5V DC
Power Consumption	<ul style="list-style-type: none"> • 13W (max.)
Operating Temperature	<ul style="list-style-type: none"> • +32 to 104 °F (0 to +40 °C)

Physical	
Dimensions (W x H x D)	<ul style="list-style-type: none"> • 6.9" x 5.8" x 1.0" (175mm x 147mm x 26mm)
Unit Weight	<ul style="list-style-type: none"> • 0.78 lbs (0.35 kg)



Stretch it, Switch it, Split it, Control it.
Gefen's got it. ®

20600 Nordhoff St., Chatsworth CA 91311
1-800-545-6900 818-772-9100 fax: 818-772-9120
www.gefentoolbox.com support@gefentoolbox.com



This product uses UL or CE listed power supplies.