

Frontplattenausschnitt (Rückseite)
Panel cut out (rear side)

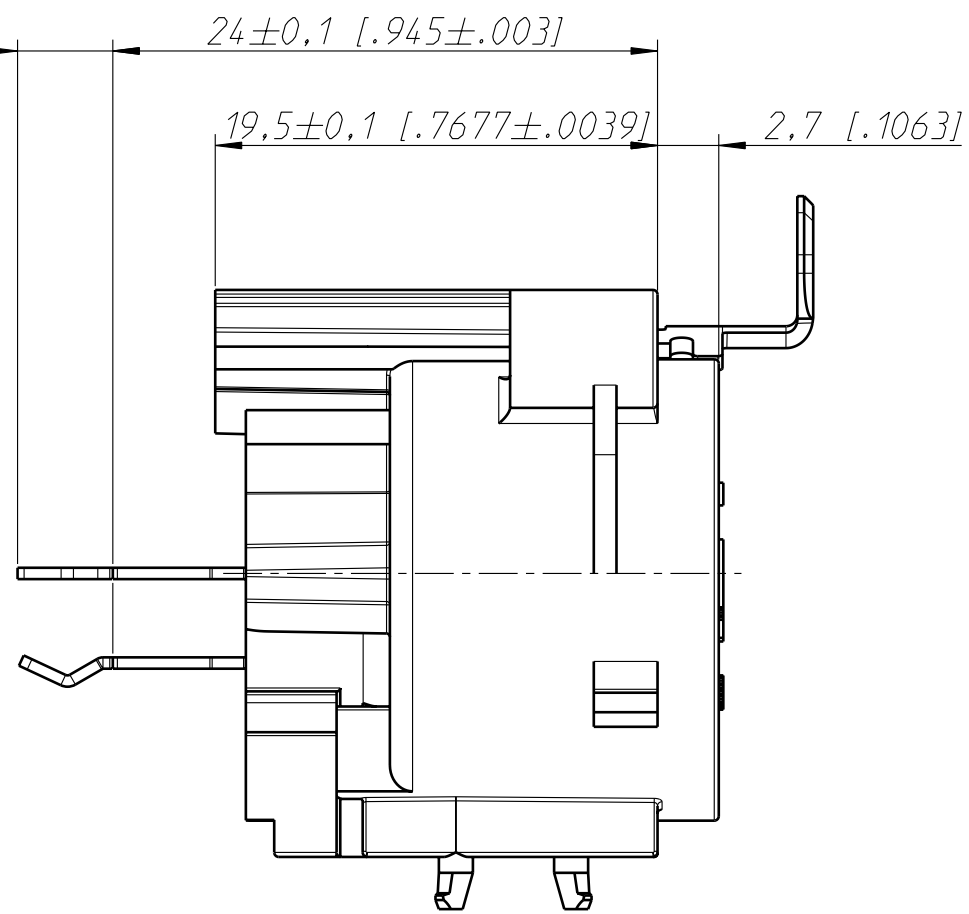

Print-Bohrplan (Bestückungsseite)
PCB-Layout (component side)

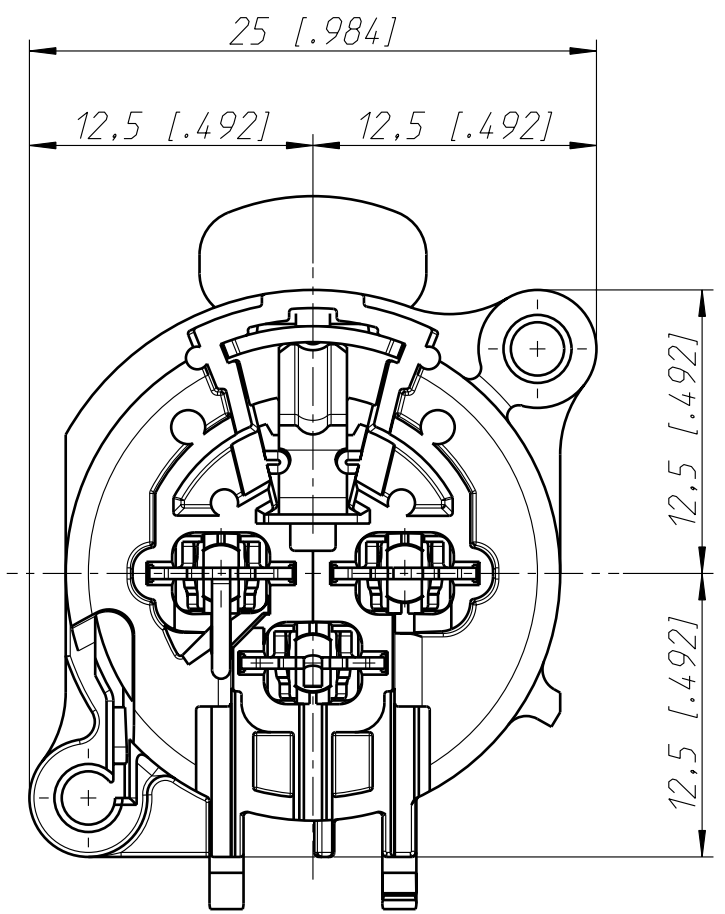

min. Einbauabstand
min assembling distance

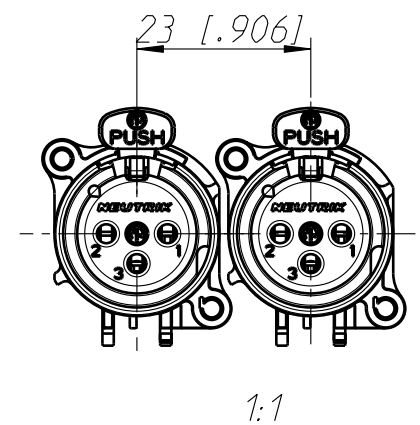
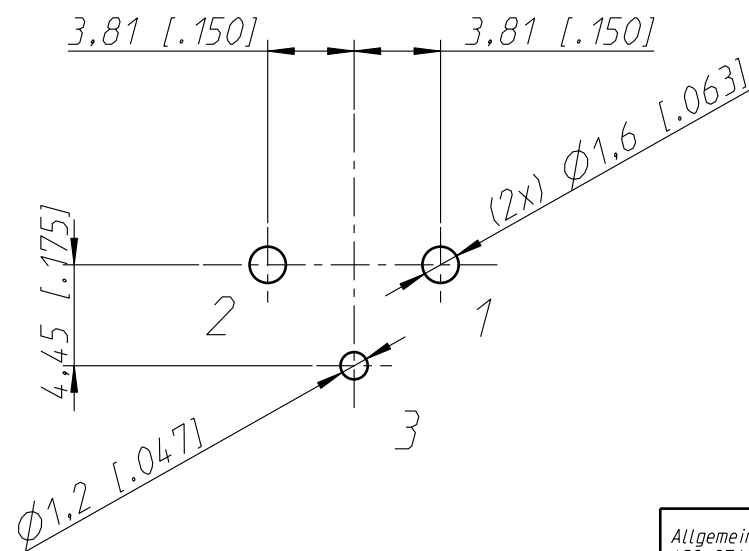
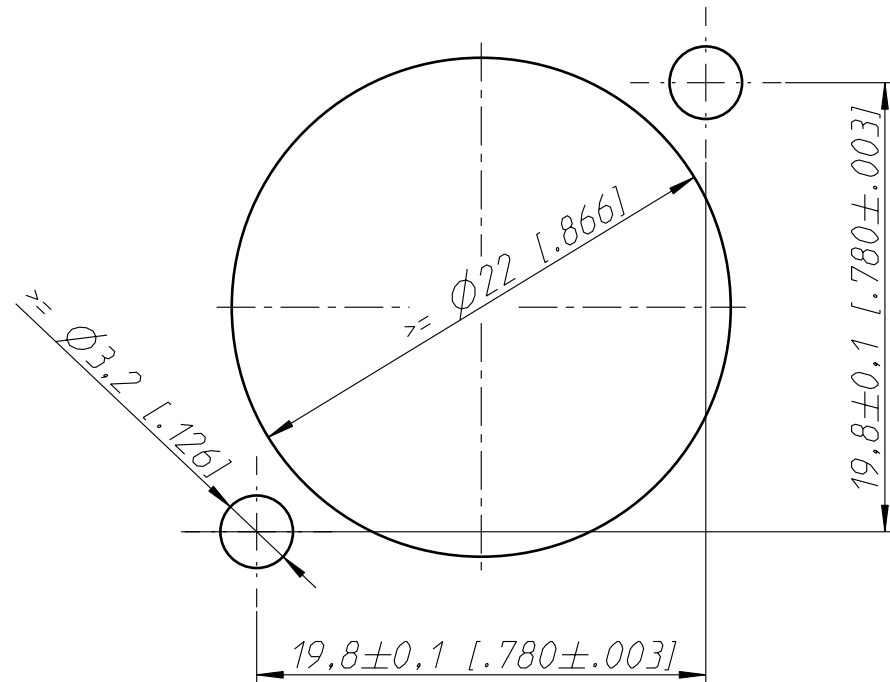

Housing material: UL94 V-0

Allgemeintoleranzen ISO 2768-m	Werkstoff	Maßstab:	Datum	Name
Zeichnung urheberrechtlich geschützt (DIN 34) (C)	-	3:1 (A3)	Gezeichnet	28.01.08 Dobler
			Freigegeben	
Benennung NC3FAV NC3FAV	-	-	Geaendert	21.11.08 Mijatovic
			Aend.-Nr.	-
			Ersatz fuer:	Blatt 1 von 1 Bl.
NEUTRIK AG FL-9494 SCHAAN			Zeichn. Nr.	ST-NC3FAV