

# Multiview Seamless Switcher

EXT-HD-MVSL-441

User Manual

Release A7

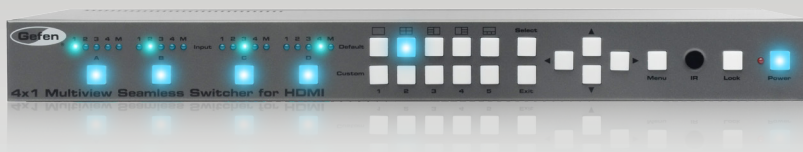

# Important Safety Instructions

## GENERAL SAFETY INFORMATION

1. Read these instructions.
2. Keep these instructions.
3. Heed all warnings.
4. Follow all instructions.
5. Do not use this product near water.
6. Clean only with a dry cloth.
7. Do not block any ventilation openings. Install in accordance with the manufacturer's instructions.
8. Do not install or place this product near any heat sources such as radiators, heat registers, stoves, or other apparatus (including amplifiers) that produce heat.
9. Do not defeat the safety purpose of the polarized or grounding-type plug. A polarized plug has two blades with one wider than the other. A grounding type plug has two blades and a third grounding prong. The wide blade or the third prong are provided for your safety. If the provided plug does not fit into your outlet, consult an electrician for replacement of the obsolete outlet.
10. Protect the power cord from being walked on or pinched particularly at plugs, convenience receptacles, and the point where they exit from the apparatus.
11. Only use attachments/accessories specified by the manufacturer.
12. To reduce the risk of electric shock and/or damage to this product, never handle or touch this unit or power cord if your hands are wet or damp. Do not expose this product to rain or moisture.
13. Unplug this apparatus during lightning storms or when unused for long periods of time.
14. Refer all servicing to qualified service personnel. Servicing is required when the apparatus has been damaged in any way, such as power-supply cord or plug is damaged, liquid has been spilled or objects have fallen into the apparatus, the apparatus has been exposed to rain or moisture, does not operate normally, or has been dropped.
15. Batteries that may be included with this product and/or accessories should never be exposed to open flame or excessive heat. Always dispose of used batteries according to the instructions.

## Warranty Information

Gefen warrants the equipment it manufactures to be free from defects in material and workmanship.

If equipment fails because of such defects and Gefen is notified within two (2) years from the date of shipment, Gefen will, at its option, repair or replace the equipment, provided that the equipment has not been subjected to mechanical, electrical, or other abuse or modifications. Equipment that fails under conditions other than those covered will be repaired at the current price of parts and labor in effect at the time of repair. Such repairs are warranted for ninety (90) days from the day of reshipment to the Buyer.

This warranty is in lieu of all other warranties expressed or implied, including without limitation, any implied warranty or merchantability or fitness for any particular purpose, all of which are expressly disclaimed.

1. Proof of sale may be required in order to claim warranty.
2. Customers outside the US are responsible for shipping charges to and from Gefen.
3. Copper cables are limited to a 30 day warranty and cables must be in their original condition.

The information in this manual has been carefully checked and is believed to be accurate. However, Gefen assumes no responsibility for any inaccuracies that may be contained in this manual. In no event will Gefen be liable for direct, indirect, special, incidental, or consequential damages resulting from any defect or omission in this manual, even if advised of the possibility of such damages. The technical information contained herein regarding the features and specifications is subject to change without notice.

For the latest warranty coverage information, refer to the Warranty and Return Policy under the Support section of the Gefen Web site at [www.gefen.com](http://www.gefen.com).

### PRODUCT REGISTRATION

**Please register your product online by visiting the Register Product page under the Support section of the Gefen Web site.**

# Contacting Gefen Technical Support

Gefen, LLC  
c/o Customer Service  
20600 Nordhoff St.  
Chatsworth, CA 91311

Telephone: (818) 772-9100  
(800) 545-6900

Fax: (818) 772-9120

Email: [support@gefen.com](mailto:support@gefen.com)

Visit us on the Web: [www.gefen.com](http://www.gefen.com)

Technical Support Hours: 8:00 AM to 5:00 PM Monday - Friday, Pacific Time

**4x1 Multiview Seamless Switcher for HDMI** is a trademark of Gefen, LLC.

### **Important Notice**

Gefen, LLC reserves the right to make changes in the hardware, packaging, and any accompanying documentation without prior written notice.

HDMI, the HDMI logo, and High-Definition Multimedia Interface are trademarks or registered trademarks of HDMI Licensing in the United States and other countries.

© 2015 Gefen, LLC. All Rights Reserved.  
All trademarks are the property of their respective owners.

## Operating Notes

- When using the 4x1 Multiview Seamless Switcher for HDMI for the first time, it is recommended that the unit be configured using the Gefen Syner-G Software Suite. The Gefen Syner-G Software Suite is free software that is available from the Support > Downloads section of the Gefen Web site.

# Licensing

This product uses software that is subject to open source licenses, including one or more of the General Public License Version 2 and Version 2.1, Lesser General Public License Version 2.1 and Version 3, BSD, and BSD-style licenses. Distribution and use of this product is subject to the license terms and limitations of liability provided in those licenses. Specific license terms and Copyright Notifications are provided in the source code.

For three years from date of activation of this product, any party may request, and we will supply, for software covered by an applicable license (e.g. GPL or LGPL), a complete machine-readable copy of the corresponding open source code on a medium customarily used for software interchange. The following software and libraries are included with this product and subject to their respective open source licenses:

- lwIP
- jQuery

lwIP is licenced under the BSD licence:

Copyright (c) 2001-2004 Swedish Institute of Computer Science.  
All rights reserved.

Redistribution and use in source and binary forms, with or without modification, are permitted provided that the following conditions are met:

1. Redistributions of source code must retain the above copyright notice, this list of conditions and the following disclaimer.
2. Redistributions in binary form must reproduce the above copyright notice, this list of conditions and the following disclaimer in the documentation and/or other materials provided with the distribution.
3. The name of the author may not be used to endorse or promote products derived from this software without specific prior written permission.

THIS SOFTWARE IS PROVIDED BY THE AUTHOR "AS IS" AND ANY EXPRESS OR IMPLIED WARRANTIES, INCLUDING, BUT NOT LIMITED TO, THE IMPLIED WARRANTIES OF MERCHANTABILITY AND FITNESS FOR A PARTICULAR PURPOSE ARE DISCLAIMED. IN NO EVENT SHALL THE AUTHOR BE LIABLE FOR ANY DIRECT, INDIRECT, INCIDENTAL, SPECIAL, EXEMPLARY, OR CONSEQUENTIAL DAMAGES (INCLUDING, BUT NOT LIMITED TO, PROCUREMENT OF SUBSTITUTE GOODS OR SERVICES; LOSS OF USE, DATA, OR PROFITS; OR BUSINESS INTERRUPTION) HOWEVER CAUSED AND ON ANY THEORY OF LIABILITY, WHETHER IN CONTRACT, STRICT LIABILITY, OR TORT (INCLUDING NEGLIGENCE OR OTHERWISE) ARISING IN ANY WAY OUT OF THE USE OF THIS SOFTWARE, EVEN IF ADVISED OF THE POSSIBILITY OF SUCH DAMAGE.

# Features and Packing List

## Features

- Seamless switcher scales and sizes each of the four inputs, and outputs them one at a time or as windows on a single display
- Input and Output resolutions up to 1080p Full HD and 1920x1200 (WUXGA)
- HDCP compliant
- Seamless switching ensures no switching delay and no picture loss during transitions
- Default pre-configured Multiview window arrangements can be accessed via five front panel preset push-buttons
- Custom user-configurable Multiview window layouts can be accessed via five front panel preset push-buttons
- User-selectable playback of HDMI audio content from any of the four inputs
- Controllable via front panel controls, IR, IP (web server interface, Telnet, and UDP), and RS-232
- Easy to use on-screen Graphical User Interface (GUI) and web server interface
- Handheld IR remote control and IR Extender input on back panel
- Field-upgradable firmware via web server interface
- USB port (reserved for future product enhancements)
- Locking power supply connector
- 1U tall rack-mountable enclosure, rack ears included



## Packing List

The 4x1 Multiview Seamless Switcher for HDMI ships with the items listed below. If any of these items are not present in your box when you first open it, immediately contact your dealer or Gefen.

- 4x1 Multiview Seamless Switcher for HDMI
- 4 x 6 ft. Locking HDMI Cables
- 1 x 6 ft. DB-9 Cable
- 1 x 12V DC Power Supply
- 1 x IR Extender Module
- 1 x IR Remote
- 1 x Set of Rack Ears
- 1 x Quick-Start Guide

# Table of Contents

## 01 Getting Started

Panel Layout .....	2
Front .....	2
Back .....	3
IR Remote Control Unit .....	4
Top .....	4
Bottom .....	6
Battery Cover .....	6
Installing the Batteries .....	7
Battery Cover .....	7
Setting the IR Channel .....	8
Installation .....	9
Connecting the 4x1 Multiview Seamless Switcher for HDMI .....	9
Sample Wiring Diagram .....	9

## 02 Operating the 4x1 Multiview Seamless Switcher for HDMI

Introduction .....	12
Standby Mode .....	12
Turning on the 4x1 Multiview Seamless Switcher for HDMI .....	12
Window Basics .....	13
Selecting a Window Configuration .....	13
Single Window Nomenclature .....	14
Changing the Routing State (Single Window) .....	17
Multiple Window Nomenclature .....	19
Masking / Unmasking Outputs .....	23
Window Priority .....	24
Assigning Window Priority .....	25
Video Effects .....	26
Using Fade .....	26
Using Chroma Key .....	27
Using Mirror .....	29
Locking / Unlocking the Switcher .....	30
Using the IR Extender .....	32
Menu System .....	33
Accessing the Menu System .....	33
Setting the Output Resolution .....	36
Adjusting the Brightness .....	38
Adjusting the Contrast .....	40
Adjusting the Saturation .....	42
Adjusting the Hue .....	44
OSD Settings .....	46
EDID Management .....	49



Mirror .....	51
Fade In-Out .....	53
Chroma Key .....	55
Changing the IP Settings .....	57
Changing the Telnet Settings .....	60
Changing the UDP Settings .....	62
System Settings .....	65

## 03 Advanced Operation

RS-232 and IP Configuration .....	68
RS-232 Interface .....	68
RS-232 Settings .....	68
IP / UDP Configuration .....	69
Commands .....	70
Web Interface .....	148
Using the built-in Web Interface .....	148
Main ► Routing .....	149
Main ► I/O Status .....	157
Main ► Display Info .....	159
I/O Setup ► Settings .....	160
I/O Setup ► HPD Control .....	162
I/O Setup ► HDCP .....	163
Window Setup .....	165
Presets .....	168
EDID ► Assign .....	170
EDID ► Bank Names .....	174
EDID ► Upload / Download .....	175
Network .....	177
System .....	181

## 04 Appendix

Upgrading the Firmware .....	186
Specifications .....	187



# Multiview Seamless Switcher

## 01 Getting Started

Panel Layout .....	2
Front .....	2
Back .....	3
IR Remote Control Unit .....	4
Top .....	4
Bottom .....	6
Battery Cover .....	6
Installing the Batteries .....	7
Battery Cover .....	7
Setting the IR Channel .....	8
Installation .....	9
Connecting the 4x1 Multiview Seamless Switcher for HDMI .....	9
Sample Wiring Diagram .....	9

# Panel Layout

## Front

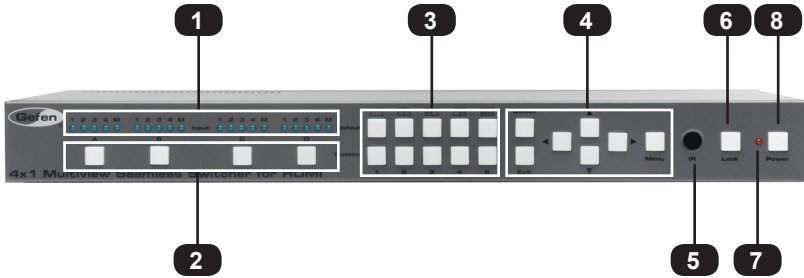

ID	Name	Description
1	Input Indicators	These LED indicators display the state of each input. See <a href="#">Window Basics</a> for more information.
2	Window Buttons	Press these buttons to display up to four windows on a single display.
3	Window Presets	Use these buttons to select the desired window configuration. Five default presets and 5 user-definable window presets are available. See <a href="#">Window Basics</a> for more information.
4	Menu System Controls	Use these buttons to select and change settings within the built-in menu system. See <a href="#">Menu System</a> for details.
5	IR	This IR sensor receives signals from the included IR remote control unit.
6	Lock	Use this button to lock the 4x1 Multiview Seamless Switcher for HDMI and prevent accidental changes. See <a href="#">Locking / Unlocking the Switcher</a> for more information on this feature.
7	Standby LED Indicator	This LED will remain illuminated when the 4x1 Multiview Seamless Switcher for HDMI is powered OFF.
8	Power	This button is used to power ON and power OFF the 4x1 Multiview Seamless Switcher for HDMI. This button will remain illuminated while the switcher is powered ON.

## Back

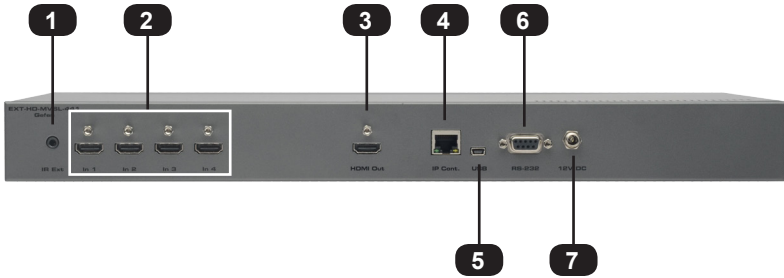

ID	Name	Description
1	IR Ext	Connect the included IR Extender (Gefen part no. EXT-RMT-EXTIRN) to this port.
2	In (1 - 4)	Connect up to four Hi-Def sources to these inputs using HDMI cables.
3	HDMI Out	Connect an HDMI cable from this port to an HD display.
4	IP Cont.	Connect a shielded CAT-5e (or better) cable between this jack and a LAN to use IP control. Refer to <a href="#">RS-232 and IP Configuration</a> for more information on setting up IP control.
5	USB	Used for upgrading the firmware. See <a href="#">Upgrading the Firmware</a> for more information.
6	RS-232	Connect an RS-232 cable from this port to an RS-232 device. See <a href="#">RS-232 and IP Configuration</a> for more information on setting up RS-232 control.
7	12V DC	Connect the included 12V DC power supply from this power receptacle to an available AC electrical outlet. Do not overtighten the locking connector on the power receptacle.

## IR Remote Control Unit

Top

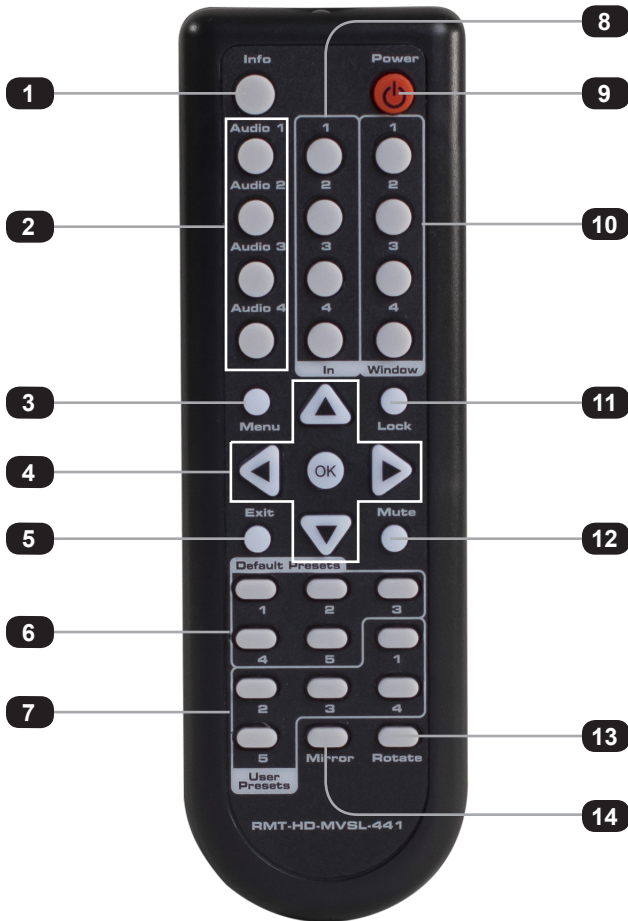

ID	Name	Description
1	Info	Used to toggle notifications on all outputs.
2	Audio (1 - 4)	Selects the audio source to be used on the output.

ID	Name	Description
3	Menu	Press this button to display the built-in menu system.
4	◀/▶/▲/▼/OK	Used to access and change features within the menu system. Use the arrow buttons to move around within the menu system or change a value. Press the OK button to make a selection within the menu system.
5	Exit	Press this button to exit the main menu or exit from sub-menus.
6	Default Presets	Use these button to select the desired window configuration. See <a href="#">Window Basics</a> for information on selecting window configurations.
7	User Presets	These buttons are used to store custom window configuration presets. See <a href="#">Window Basics</a> for more information.
8	In (1 - 4)	Use this buttons to select the input.
9	Power	Press this button to power-ON or power-OFF the Multiview Seamless Switcher.
10	Window (1 - 4)	Use these buttons to select the desired window. Each of these buttons is associated with the buttons on the front panel (Window A - D). See <a href="#">Window Basics</a> for more information on working with windows and inputs.
11	Lock	Press this button to lock or unlock the 4x1 Multiview Seamless Switcher for HDMI.
12	Mute	Mutes the audio on all outputs.
13	Rotate	Press this button to cycle through right-90°, 180°, left 90°, and no rotation. Only single-window mode can be rotated.
14	Mirror	Applies a horizontal transformation (rotated 180° about the y-axis) to window output A.

## Bottom

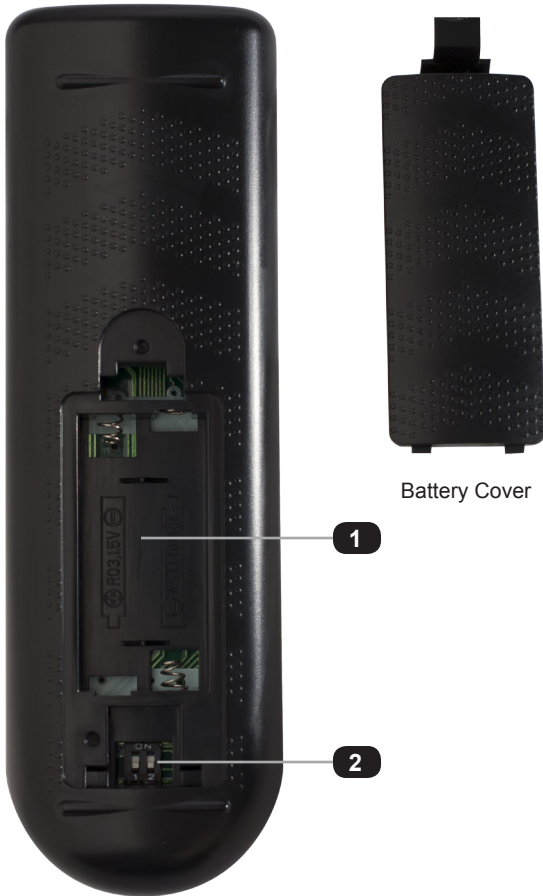

Battery Cover

ID	Name	Description
1	Battery slot (shown without batteries)	Holds the batteries for operating the IR remote. Use only 1.5V "AAA"-type batteries. See <a href="#">Installing the Batteries</a> for information on battery installation.
2	DIP switch bank	Use these DIP switches to set the IR channel of the remote. See <a href="#">Setting the IR Channel</a> for details.



## Installing the Batteries

1. Remove the battery cover on the bottom of the IR remote control unit.
2. Make sure that the batteries are installed with the correct polarity, as shown in the illustration, below. Always use two 1.5V AAA-type batteries.
3. Replace the battery cover.







**WARNING:** Risk of explosion if battery is replaced by an incorrect type. Dispose of used batteries according to the instructions.

## Setting the IR Channel

In order to function correctly, both the switcher and the IR remote control must be set to the same IR channel. To set the IR channel of the switcher, use the `#set_ir` command or use the IR Channel setting under the [System](#) page of the Web interface.



DIP switches

IR Channel	DIP settings
0	<div style="border: 1px solid black; padding: 5px; text-align: center;"> <p>ON</p>  <p>1 2</p> </div>
1	<div style="border: 1px solid black; padding: 5px; text-align: center;"> <p>ON</p>  <p>1 2</p> </div>
2	<div style="border: 1px solid black; padding: 5px; text-align: center;"> <p>ON</p>  <p>1 2</p> </div>
3	<div style="border: 1px solid black; padding: 5px; text-align: center;"> <p>ON</p>  <p>1 2</p> </div>

# Installation

## Connecting the 4x1 Multiview Seamless Switcher for HDMI

1. Connect up to four Hi-Def sources to the input ports (**In 1 - In 4**) ports on the 4x1 Multiview Seamless Switcher for HDMI.
2. Connect an HD display to the **HDMI Out** port on the 4x1 Multiview Seamless Switcher for HDMI.
3. OPTIONAL: Connect an RS-232 cable from the **RS-232** port on the 4x1 Multiview Seamless Switcher for HDMI to the RS-232 connector on the automation controller.
4. OPTIONAL: Connect a CAT-5e (or better) cable from the **IP Control** port on the 4x1 Multiview Seamless Switcher for HDMI to a Local Area Network (LAN).
5. OPTIONAL: Connect the included IR extender to the **IR Ext** port on the 4x1 Multiview Seamless Switcher for HDMI.
6. Connect the included 12V DC locking power supply to the power receptacle on the 4x1 Multiview Seamless Switcher for HDMI. Do not overtighten the locking power connector.
7. Connect the power supply to an available electrical outlet.

### Sample Wiring Diagram

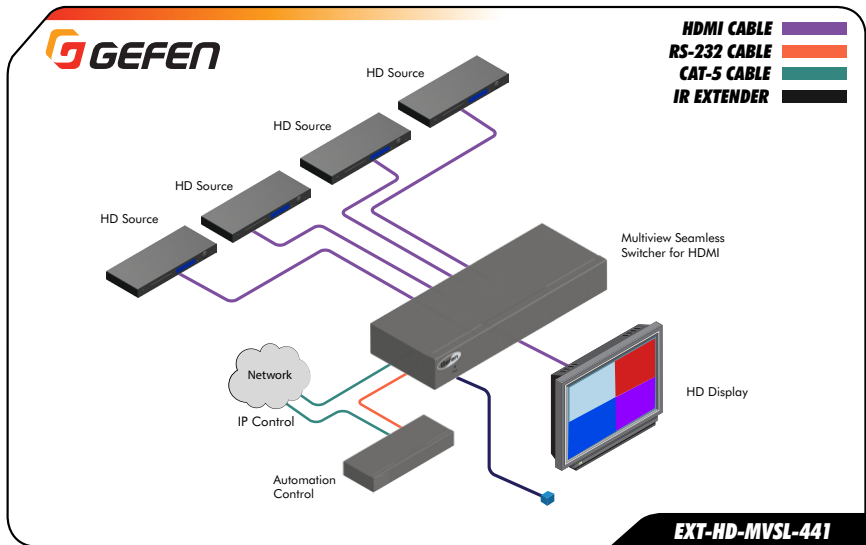



# Multiview Seamless Switcher

## 02 Operating the 4x1 Multiview Seamless Switcher for HDMI

Introduction.....	12
Standby Mode.....	12
Turning on the 4x1 Multiview Seamless Switcher for HDMI .....	12
Window Basics.....	13
Selecting a Window Configuration .....	13
Single Window Nomenclature.....	14
Changing the Routing State (Single Window).....	17
Multiple Window Nomenclature.....	19
Masking / Unmasking Outputs.....	23
Window Priority.....	24
Assigning Window Priority.....	25
Video Effects.....	26
Using Fade.....	26
Using Chroma Key.....	27
Using Mirror.....	29
Locking / Unlocking the Switcher.....	30
Using the IR Extender.....	32
Menu System.....	33
Accessing the Menu System.....	33
Setting the Output Resolution.....	36
Adjusting the Brightness.....	38
Adjusting the Contrast.....	40
Adjusting the Saturation.....	42
Adjusting the Hue.....	44
OSD Settings.....	46
EDID Management.....	49
Mirror.....	51
Fade In-Out.....	53
Chroma Key.....	55
Changing the IP Settings.....	57
Changing the Telnet Settings.....	60
Changing the UDP Settings.....	62
System Settings.....	65

# Introduction

## Standby Mode

The LED next to the **Power** button, on the front panel, indicates the power state of the 4x1 Multiview Seamless Switcher for HDMI. In *standby mode*, power is being supplied to the 4x1 Multiview Seamless Switcher for HDMI but the unit is not turned on. This LED will be red and remain illuminated as long as the unit is in *standby mode*. If this LED does not illuminate, check the connection between the power receptacle on the 4x1 Multiview Seamless Switcher for HDMI and the AC outlet.

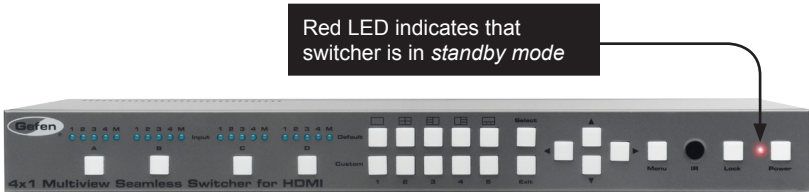

## Turning on the 4x1 Multiview Seamless Switcher for HDMI

Press the **Power** button to power-on the switcher. The **Power** button will turn blue and remain illuminated as long as the switcher is powered-on. To power-off the 4x1 Multiview Seamless Switcher for HDMI and return to *standby mode*, press the **Power** button again.



## Window Basics

### Selecting a Window Configuration

The 4x1 Multiview Seamless Switcher for HDMI provides the ability to display four Hi-Def sources on one HD display. In addition, the 4x1 Multiview Seamless Switcher for HDMI allows the creation of an infinite number of window configurations using the built-in Web interface. Windows can be individually scaled, resized, and positioned within any area of the display area.

The 4x1 Multiview Seamless Switcher for HDMI comes with 5 *default* window presets. An illustration of each of these window presets is displayed above each of the Default preset buttons on the front panel:

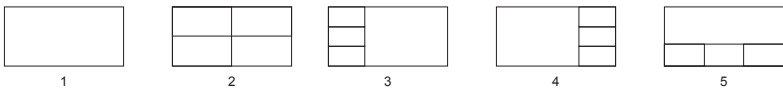

These presets can be selected from the top-row of buttons on the front panel. The button for the currently selected window configuration will turn blue and remain illuminated as long as the preset is selected.

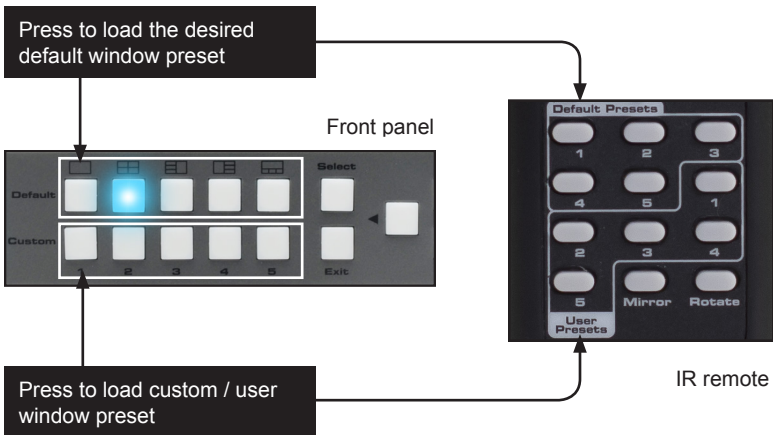

The bottom row of buttons are used to store and recall *custom* presets. Custom presets are created and saved using the built-in Web interface. See the [Presets](#) section of the Web interface for more information.

When the 4x1 Multiview Seamless Switcher for HDMI is shipped from the factory, the Default 2 preset will be automatically loaded when the unit is powered-ON.

### Single Window Nomenclature

The 4x1 Multiview Seamless Switcher for HDMI can display up to four sources on one display. When multiple sources are displayed on the screen, we refer to each source as a *window*. In general terms, a *window* is defined as an input. However, before we discuss multiple windows, we will define the operation of a single window.

In our example, below, we have four Hi-Def sources connected to the 4x1 Multiview Seamless Switcher for HDMI. Each source is represented by a colored rectangle. When the 4x1 Multiview Seamless Switcher for HDMI is shipped from the factory, the Default 2 preset will automatically be loaded when the unit is powered ON:

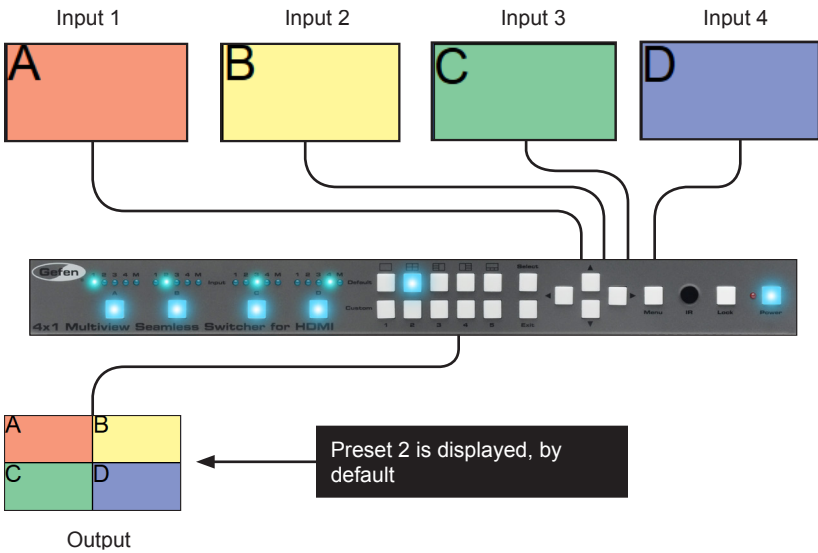

Now, let's look at one of the default presets that displays a single-window output:

1. Press the Default 1 button on the front panel.

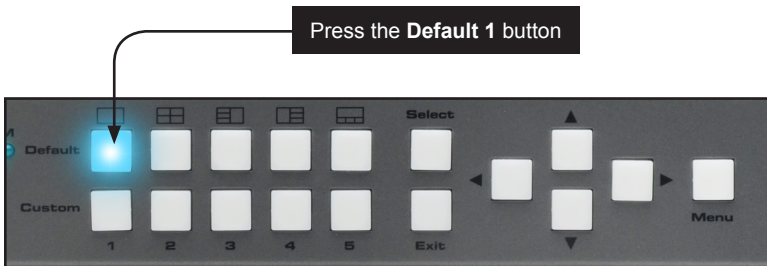



The Default 1 preset uses *Window A*:



To switch to the Default 1 single-window configuration using the IR remote control, press the Default Preset 1 button.

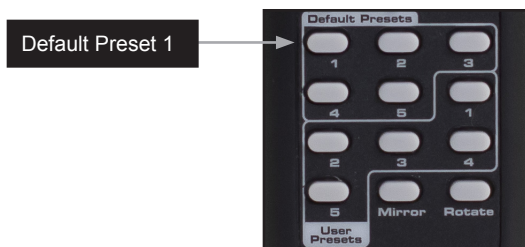

- The image displayed on the output will be dictated by the current routing state of the matrix. In this example, the source that is connected to Input 2 is displayed.

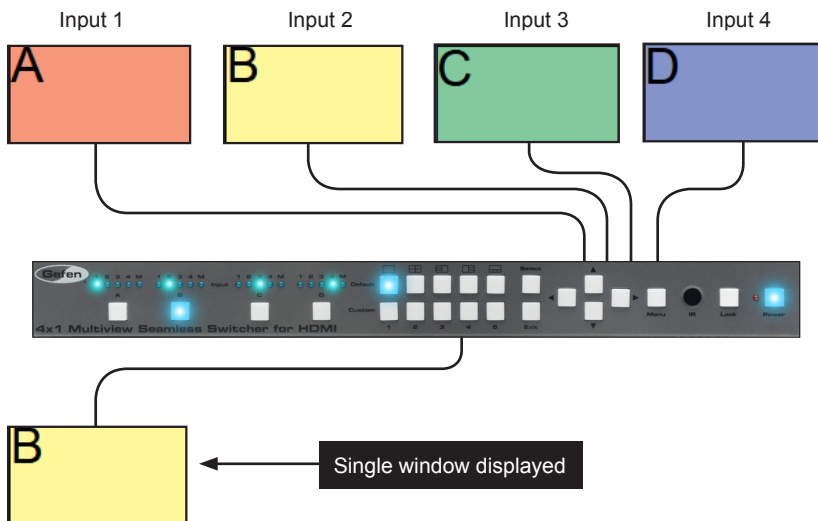

(continued on next page)

Note that on the previous page that Window B is displayed. This is because the button for Windows B was pressed. The button for the current Window will remain illuminated until another Window button is pressed.

In single-window mode, each Window button (A - D) on the front panel represents one of the four inputs.

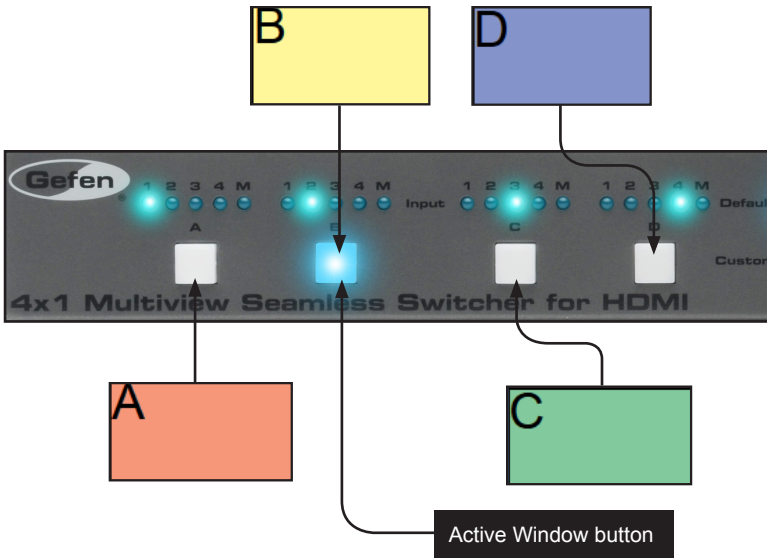

3. Try pressing each of the Window buttons on the front panel and observe how the image on the display changes.

The included IR remote control can also be used to switch between Windows by pressing the Window buttons.

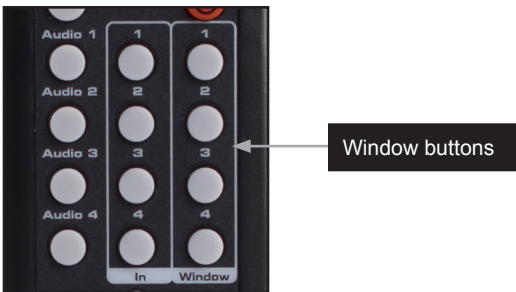

## Changing the Routing State (Single Window)

There are two methods for performing this operation: 1) Select a different Window button with a different input . 2) Change the routing state for the current output. We will cover both methods.

For this example, we want to view the source connected to Input 3.

Method 1:

1. Press Window C on the front panel.

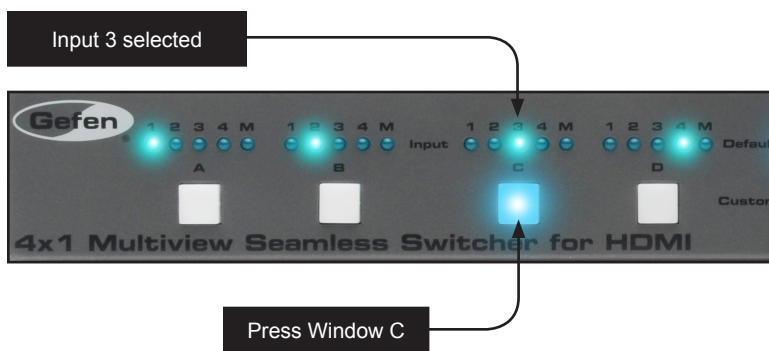

If using the IR remote control, press the Window 3 button.

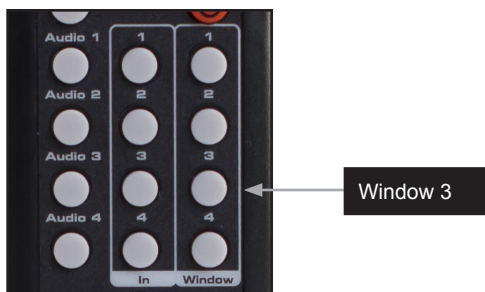

- The numbers in each of the colored boxes, below, represent the currently select input for each Window. Since Input 3 has already been routed to Window C, the source connected to Input 3 will be displayed:

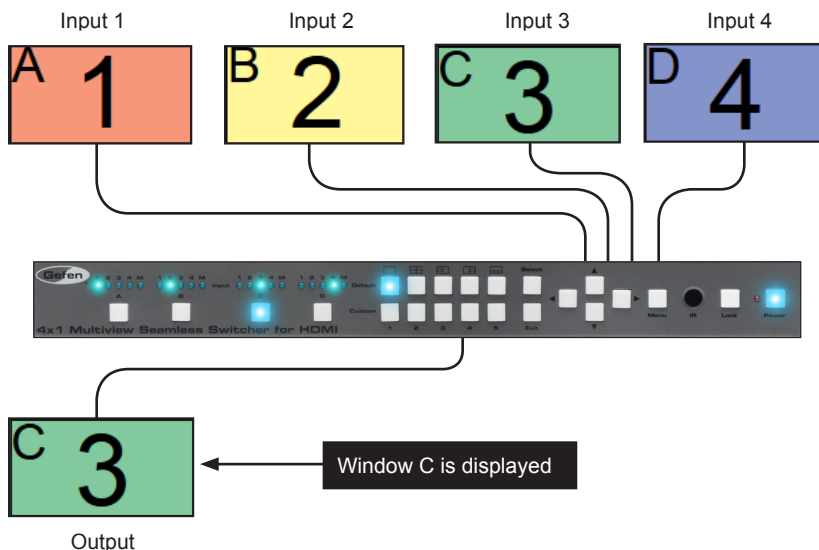

Method 2:

- Press the button for Window B on the front panel to select it.
- Press the button for Window B again to select Input 3.

If using the IR remote control, press the Window 2 button, then press the In 3 button.

- Input 3 has now been routed to Window B. Since Window B is the active output, the source connected to Input 3 will be displayed:



Note that the Window name is the same. The only difference is that the input has changed.

## Multiple Window Nomenclature



**NOTE:** The 4x1 Multiview Seamless Switcher for HDMI is designed to be used as a 2x2 video wall. 4x1 rows and 1x4 columns are not supported.

To recap, the 4x1 Multiview Seamless Switcher for HDMI can display up to four sources on one display. When multiple sources are displayed on the screen, we refer to each source as a *window*. In general terms, a *window* is defined as an input. It is recommended that the [Single Window Nomenclature](#) section be read before continuing.

When working with a single window, we saw how we could switch inputs, allowing us to view different sources, one at a time.

In order for the switcher to display more than one window at a time, the switcher identifies each window using an alphabetic character.

Default 1 preset is identified as *Window B*.



Default 2 preset is identified as follows:

Each window is also assigned a default input, which is notated by a numeral from 1 to 4.

Window A will use Input 1, Window B will use Input 2, and so on. Of course, any input can be assigned to any window.

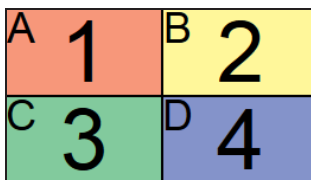

Another example is the Default 3 window preset:



Although the arrangement of each window--or the input to each window--can be different, the window ID (A - D) does not change.

When using multiple windows, multiple window buttons will be active. We will continue with the last example in the [Single Window Nomenclature](#) section to the difference.

In the illustration, below, Window C has been selected. Input 3 is routed to Window C. Therefore, the source connected to Input 3 is displayed.

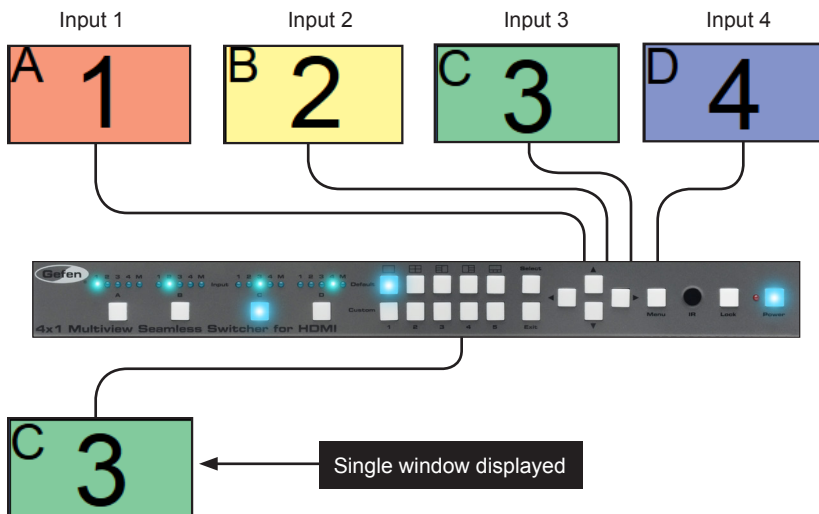

1. Press the Default 2 button. This will create a basic 2x2 multi-window display.

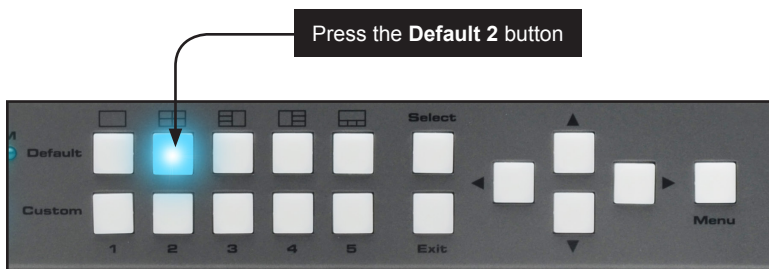

- The image on the output will be equally divided into four windows. This window arrangement is used by Default Preset 2.

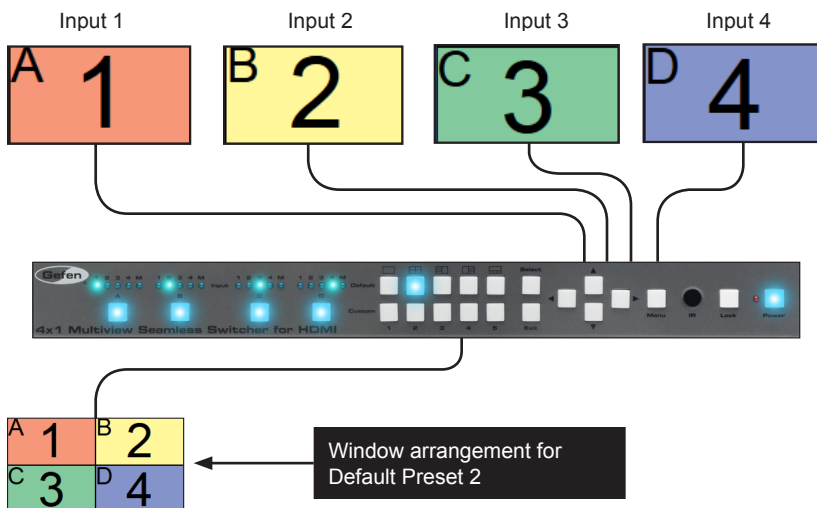

- Now, let's change the routing state so that the source connected to Input 2 covers the top half of the screen.

If we look at our window template for Default 2, we can see that routing Input 2 to Window A will accomplish this task.

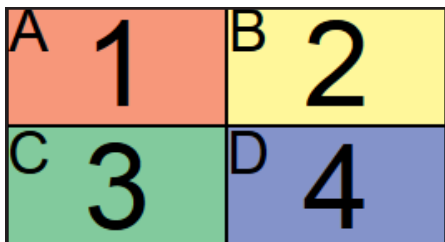

- 4. Press the button for Output A once. The LED indicator will change from Input 1 to Input 2.

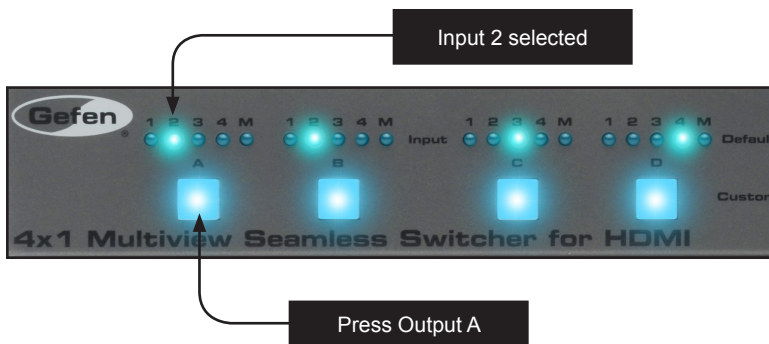

- 5. The output on the display will now appear, as follows:

A	2	B	2
C	3	D	4



## Masking / Unmasking Outputs



**NOTE:** Masking must be performed by using the buttons on the front panel or through the built-in Web interface.

“Masking” prevents a window from displaying the signal from the source device. Instead of powering-down or disconnecting the input device, individual or multiple outputs can be masked. Masking can be used with single window and multiple-window configurations.

### Using the Front Panel Buttons

1. Press the button of the desired output to be masked. For this example, we will select Window B:



Press Output B

2. Continue pressing the button for Window B until the “M” LED indicator is illuminated.

Output B is masked

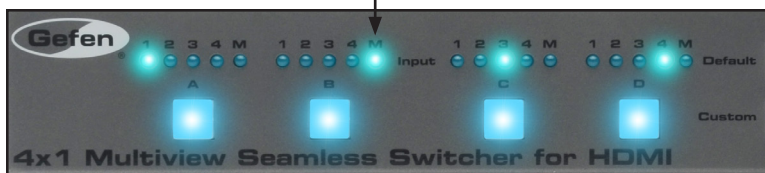

3. To unmask an window, press the button for the window and select the desired input.

## Window Priority

The built-in Web interface allows windows to be re-sized and arranged in any order. Windows can also be placed above or below one another. The ordering of overlapping objects in two-dimensional space is sometimes referred to as the *z-order*.

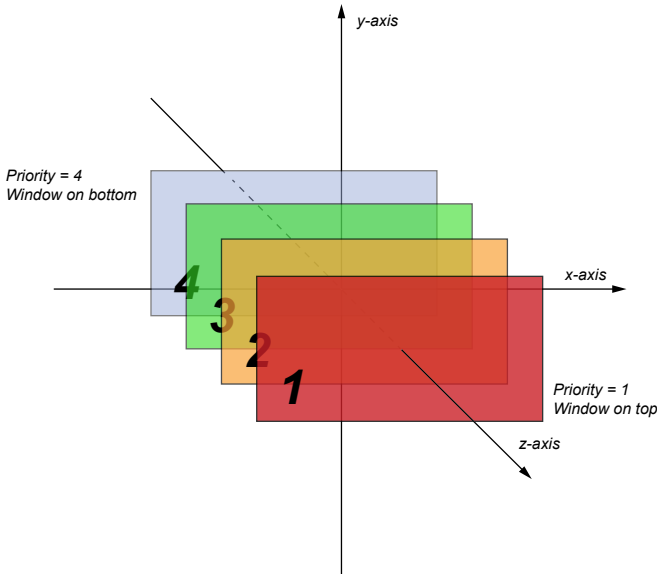

**NOTE:** Window B is always set to priority 1 and cannot be changed. Refer to [Single Window Nomenclature](#) for more information.

In the illustration above, the red window is set to priority 1 and will be displayed on top of all other windows. Setting a window to priority 4 (the blue window) will move the window to the bottom-most position. The *smaller* the number, the *higher* priority. Multiple windows *cannot* share the same priority.

Note that the 4x1 Multiview Seamless Switcher for HDMI does not allow a window to have a transparency property. This is only used by the diagram, above, to illustrate how windows can be placed behind or in front of one another.

## Assigning Window Priority

1. Access the Web interface for the 4x1 Multiview Seamless Switcher for HDMI. See the [Web Interface](#) for more information.
2. Go to the [Window Setup](#) page of the Web interface.
3. We've selected Preset - 8 from the **Select Preset** drop-down list. We've also repositioned and resized the windows, as follows:

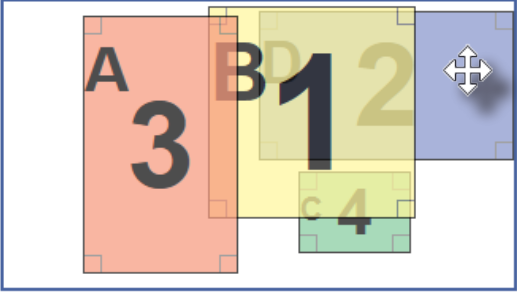

The screenshot shows a workspace with four overlapping windows labeled A, B, C, and D. Window A is orange, B is yellow, C is green, and D is blue. A mouse cursor is over window D. To the right is a configuration panel with the following settings:

Select Preset	Current - Preset 8
Select Window	D
Width	951
Height	560
X Position	966
Y Position	37
Priority	4

4. Select one of the windows by clicking on it or selecting it from the **Select Window** drop-down list. For this example, we are going to select window D and make it the top-most window.
5. The current priority of the selected window will appear in the **Priority** drop-down list.
6. Select 1 from the **Priority** drop-down list.

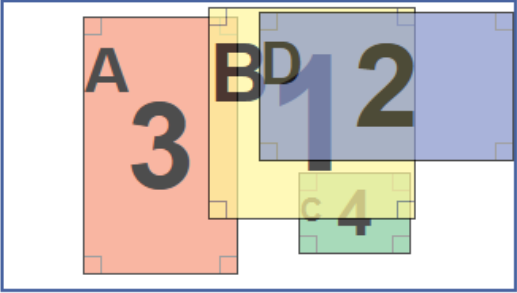

The screenshot shows the same workspace as before, but window D is now the top-most window. The configuration panel on the right has been updated:

Select Window	D
Width	951
Height	560
X Position	966
Y Position	37
Priority	1

7. Window D is now the top-most window. This window can be positioned anywhere within the interactive workspace and the window will appear on top of all windows.
8. Click the **Save** button to save any changes to the preset.

## Video Effects



**NOTE:** Video effects are only applicable to single-window applications. Multiple-window effects are not supported.

When using single windows, the 4x1 Multiview Seamless Switcher for HDMI provides three unique post-production video effects: Fade, Chroma Key, and Mirror.

### Using Fade

The *fade* effect applies a one-second cross-dissolve transition when switching between windows that are receiving video from different sources. This feature, as with all video effects, is only available when viewing a single window output.



1. Access the Web interface for the 4x1 Multiview Seamless Switcher for HDMI. See the section [Web Interface](#) for more information.
2. Selecting the **Routing** tab.
3. Click the radio button next to the **Default 1** preset.
4. Click to place a check mark in the **Fade** check box.

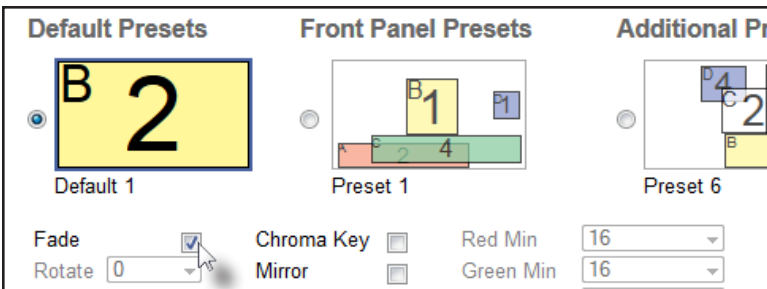

5. To see the fade effect, switch between outputs using the IR remote control or the window buttons on the front panel.

## Using Chroma Key

The *chroma key* effect, also referred to as “color-keying”, is a post-production technique for layering two images or video signals together. The first layer involves filming a subject in front of a solid color background. The second layer serves as the background for the final composite image. By combining the two images together and removing (“keying”) the background color from the first layer, the subject will appear in front of the background from the second layer. When chroma-keying a live feed (e.g. a meteorologist standing in front of a weather map), a “traveling matte” is created.



Subject  
(Window B)

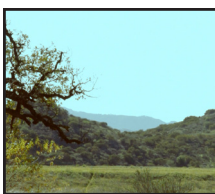

Background  
(Window A)



Final Composite  
(Window B)

1. Access the Web interface for the 4x1 Multiview Seamless Switcher for HDMI. See the section [Web Interface](#) for more information.
2. Selecting the **Routing** tab.
3. Click the radio button next to the **Default 1** preset.
4. Route the image with the subject and solid color background to **Window B**.
5. Route the background image to **Window B**.
6. Click to place a check mark in the **Chroma Key** check box.

The screenshot shows the Web interface for the 4x1 Multiview Seamless Switcher for HDMI. It displays three sections: Default Presets, Front Panel Presets, and Additional Presets. The 'Default Presets' section shows 'Default 1' selected, which is represented by a yellow square with a black '2' and a blue 'B' in the top left corner. The 'Front Panel Presets' section shows 'Preset 1' selected, which is represented by a diagram with a yellow square labeled 'B 1' and a blue square labeled '1'. The 'Additional Presets' section shows 'Preset 6' selected, which is represented by a diagram with a blue square labeled 'B 4' and a yellow square labeled '2'. Below the presets, there are controls for 'Fade' (checkbox), 'Rotate' (dropdown set to '0'), 'Chroma Key' (checkbox checked), 'Mirror' (checkbox), 'Red Min' (dropdown set to '16'), and 'Green Min' (dropdown set to '16').

Because shadows and other lighting imperfections are always present when photographing a subject against a solid color background, the background will never be a pure RGB value (as shown below). For this reason, a color range with minimum and maximum values needs to be specified.

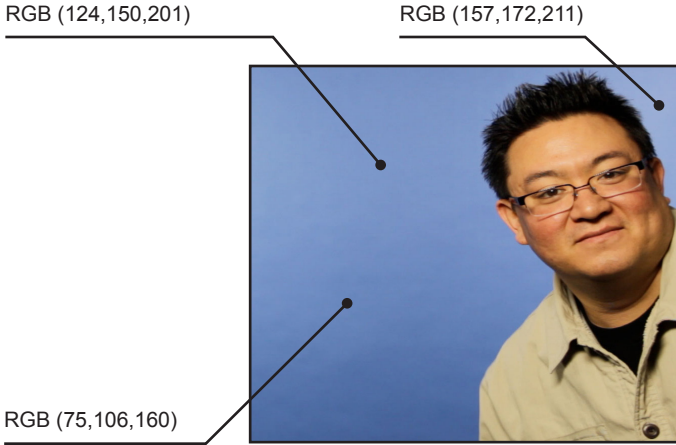

- Set the Min RGB values for the color to be “keyed”.

Red Min	<input type="text" value="0"/>	Red Max	<input type="text" value="0"/>
Green Min	<input type="text" value="16"/>	Green Max	<input type="text" value="0"/>
Blue Min	<input type="text" value="32"/>	Blue Max	<input type="text" value="0"/>

- Set the Max RGB values for the color to be “keyed”.

Red Min	<input type="text" value="0"/>	Red Max	<input type="text" value="0"/>
Green Min	<input type="text" value="16"/>	Green Max	<input type="text" value="48"/>
Blue Min	<input type="text" value="32"/>	Blue Max	<input type="text" value="240"/>

- The final composite will be displayed on **Window A**.

## Using Mirror

The *mirror* effect, applies a horizontal transformation (rotated 180° about the y-axis) to window Output A.

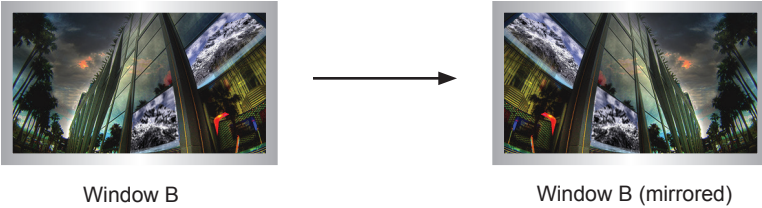

1. Access the Web interface for the 4x1 Multiview Seamless Switcher for HDMI. See the section [Web Interface](#) for more information.
2. Selecting the **Routing** tab.
3. Click the radio button next to the **Default 1** preset.
4. Click to place a check mark in the **Mirror** check box.

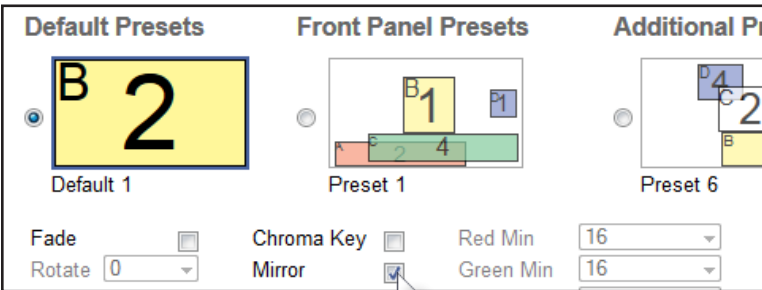

5. The image on **Window B** will be flipped horizontally.

## Locking / Unlocking the Switcher

Locking the switcher will prevent any changes by disabling all buttons (except the Lock button) on the front panel. This feature is useful in preventing routing or other changes caused by accidentally bumping or pressing the buttons on the front panel.

### Using the Front Panel Buttons

1. Press and hold the **Lock** button on the front panel. The **Lock** button will begin to flash.
2. Continue holding down the **Lock** button until it stops flashing.
3. The switcher is now locked. The **Lock** button will remain illuminated as long as the switcher is locked.

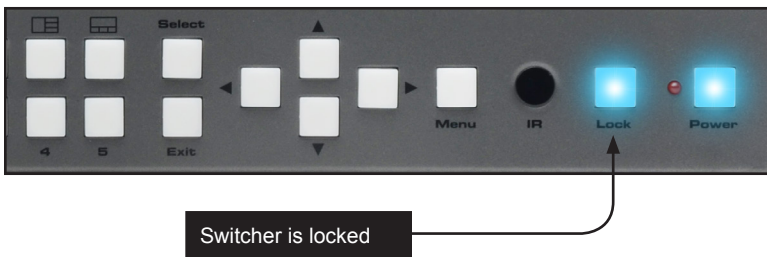

4. To unlock the switcher, press and hold the **Lock** button. The **Lock** button will begin to flash.
5. Continue holding down the **Lock** button until it stops flashing.
6. The switcher is now unlocked and can be used normally.

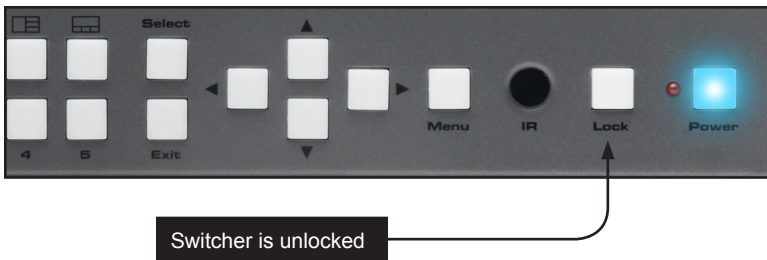

Once the switcher is unlocked, the **Lock** button will no longer be illuminated.



Using the IR Remote Control

1. Press the **Lock** button on the IR remote control.

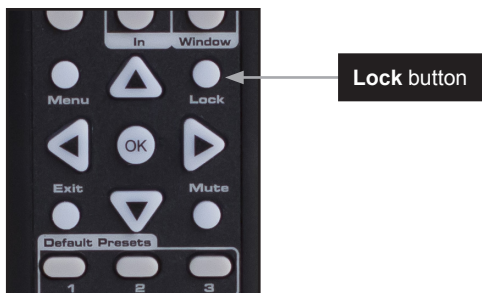

2. The **Lock** button, on the front panel of the switcher, will remain illuminated as long as the switcher is locked.

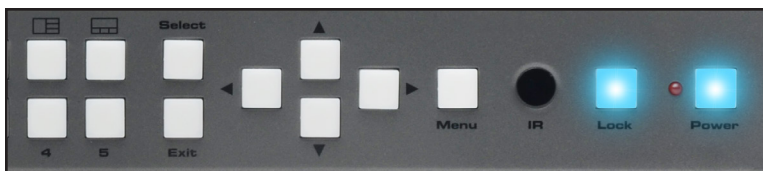

3. To unlock the switcher, press the **Lock** button. The **Lock** button will turn off.

The switcher is now unlocked and can be used normally.

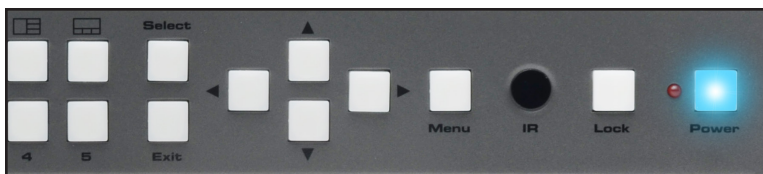

Once the switcher is unlocked, the **Lock** button will no longer be illuminated.

## Using the IR Extender

There may be situations where the IR sensor is blocked by a cabinet or other mounting device. In this case, the included IR extender (Gefen part no. EXT-RMT-EXTIRN) can be connected to the **IR Ext** port on the 4x1 Multiview Seamless Switcher for HDMI. The sensor on the IR extender behaves exactly like the sensor on the front panel of the switcher. Always point the IR remote control unit in the direction of the IR sensor.

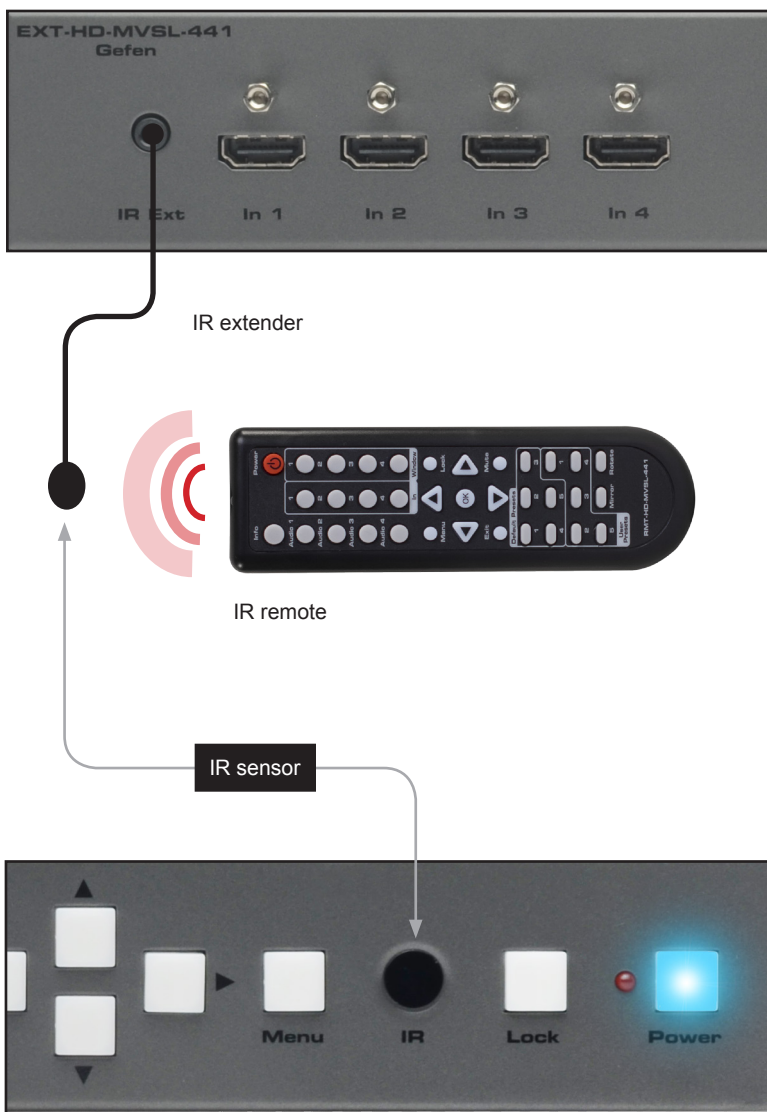

# Menu System

## Accessing the Menu System

The HD Video Wall Controller uses a built-in menu system to manage and control all video features. To access the menu system, press the **Menu** button on the front panel or on the included IR remote control.

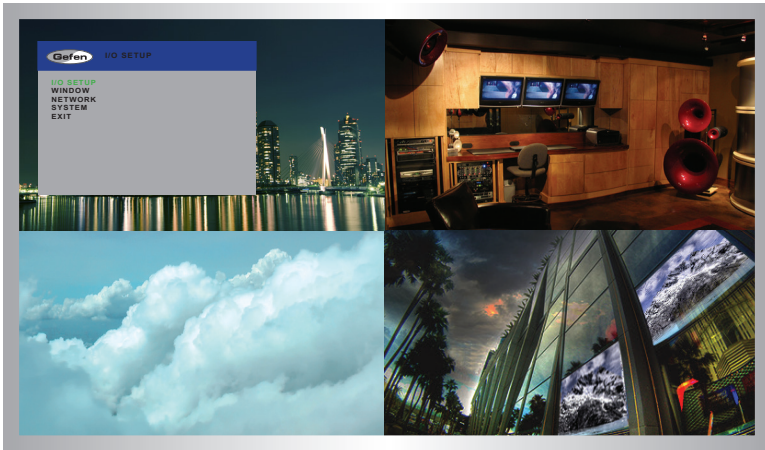

After pressing the **Menu** button on the front panel, the **Menu** button will remain illuminated as long as the menu system is displayed on the screen. By default, the menu system will be displayed within the top-left display.

The time-out value (duration) for the menu system can be changed in the [OSD Settings](#) page of the menu system.

## Using the Front Panel Controls

Use the ◀, ▶, ▲, and ▼ buttons on the front panel to move around within the menu system. Press the ▲ and ▼ buttons to move up and down. Press the ◀ or ▶ buttons to change the value of the current selection. Press the **Select** button to make the desired selection. The current selection will be highlighted in green.

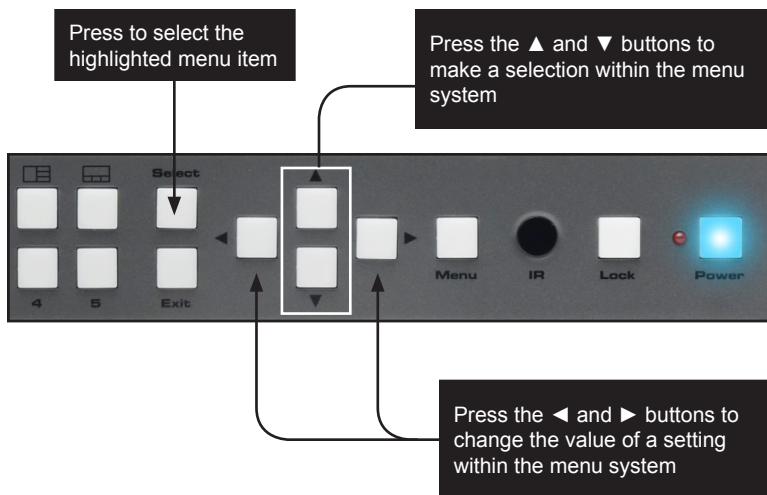
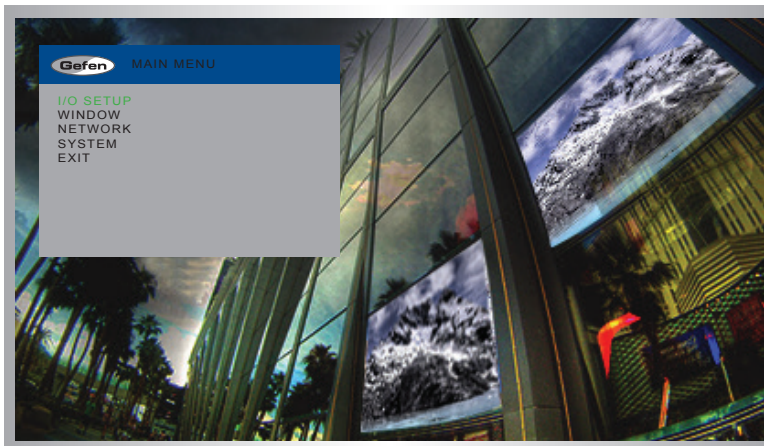

## Using the IR Remote Control

The IR remote control has buttons which represent the controls on the front panel. Use the ◀, ▶, ▲, and ▼ buttons to move around within the menu system. Press the ▲ and ▼ buttons to move up and down. Press the ◀ or ▶ buttons to change the value of the current selection. Press the **OK** button to make the desired selection. The current selection will be highlighted in green.



Press to select the highlighted menu item

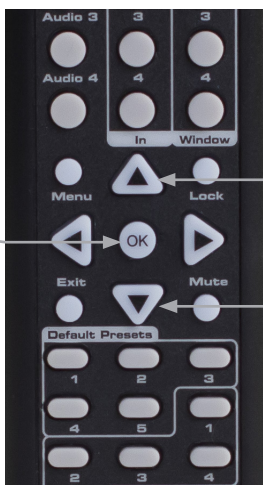

Press the ▲ and ▼ buttons to move up and down within the menu system

## Setting the Output Resolution



**NOTE:** Before changing this setting, make sure that all connected displays can support the selected output resolution.

1. Press the **Menu** button on the front panel or on the IR remote control. The menu system will be displayed.

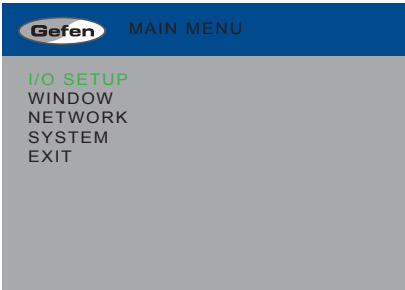

2. Press the **Select** button to display the **I/O Setup** menu. If using the IR remote, press the **OK** button.

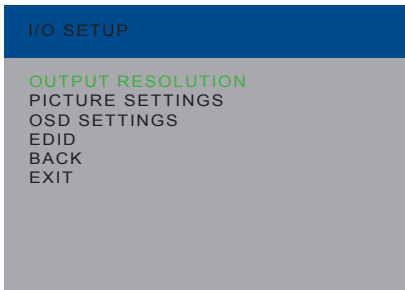

3. Press the **Select** button again to display the **Output Resolution** menu. If using the IR remote, press the **OK** button.

5. Use the ▲ or ▼ buttons to highlight the desired output resolution.

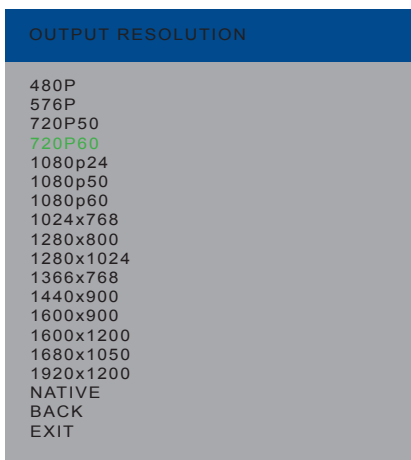

6. Press the **Select** button to apply the highlighted resolution. If using the IR remote, press the **OK** button.

If the display does not support the selected resolution, use the `#fadefault` command to reset the 4x1 Multiview Seamless Switcher for HDMI.

See [RS-232 and IP Configuration](#) for more information on commands.

## Adjusting the Brightness

1. Press the **Menu** button on the front panel or on the IR remote control. The menu system will be displayed.

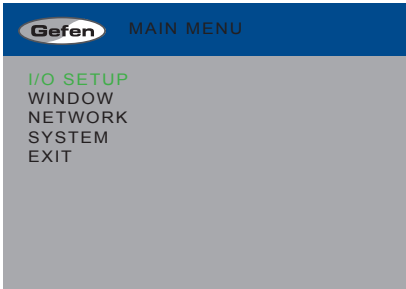

2. Press the **Select** button to display the **Setup Menu**. If using the IR remote, press the **OK** button.
3. Use the **▲** or **▼** buttons to highlight **Picture Settings**.

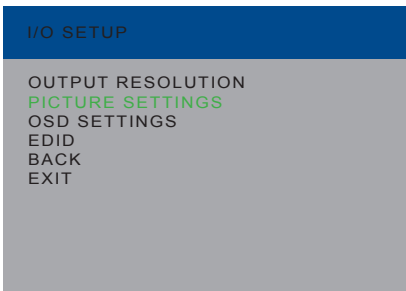

4. Press the **Select** button to display the **Picture Settings** menu. If using the IR remote, press the **OK** button.
5. The **Input** option should be highlighted. If not, use the **▲** or **▼** buttons to highlight it. Each input can have individual contrast settings. Therefore, the input must be selected before making changes to it.

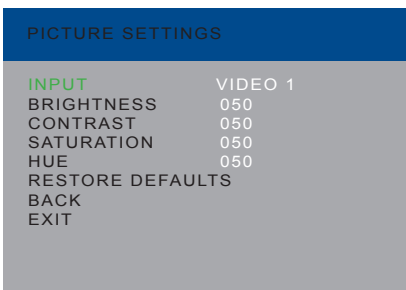



6. Press the **Select** button to select the **Input** option. The currently selected input will be highlighted in orange.
7. Select the desired input using the ◀ or ▶ buttons.

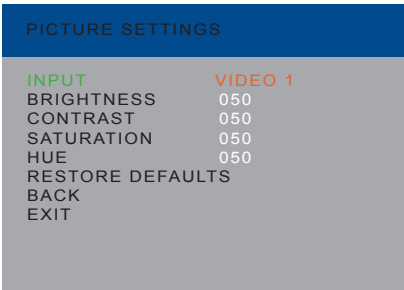

8. Press the **Select** button to accept the current input selection.
9. Use the ▲ or ▼ buttons to highlight the **Brightness** option.
10. Press the **Select** button to select the **Brightness** option.
11. Change the brightness value using the ◀ or ▶ buttons.

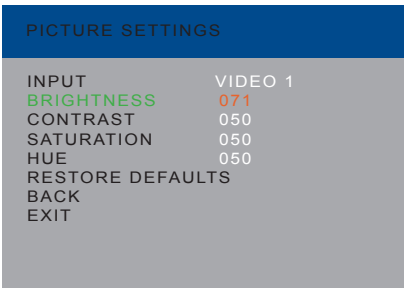

12. Press the **Select** button to accept the change.

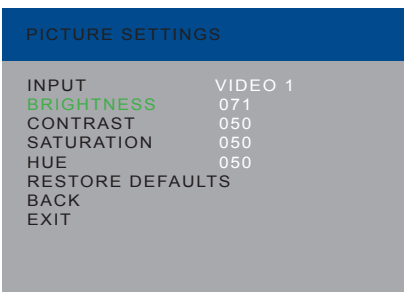

## Adjusting the Contrast

1. Press the **Menu** button on the front panel or on the IR remote control. The menu system will be displayed.

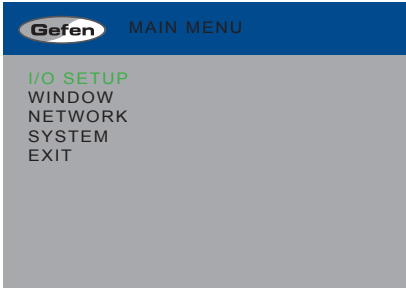

2. Press the **Select** button to display the **Setup Menu**. If using the IR remote, press the **OK** button.
3. Use the **▲** or **▼** buttons to highlight **Picture Settings**.

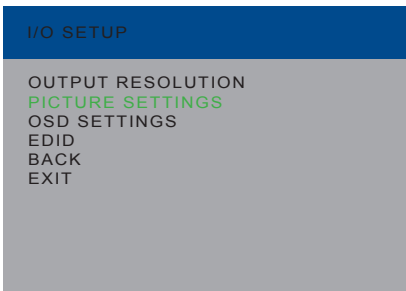

4. Press the **Select** button to display the **Picture Settings** menu. If using the IR remote, press the **OK** button.
5. The **Input** option should be highlighted. If not, use the **▲** or **▼** buttons to highlight it. Each input can have individual contrast settings. Therefore, the input must be selected before making changes to it.

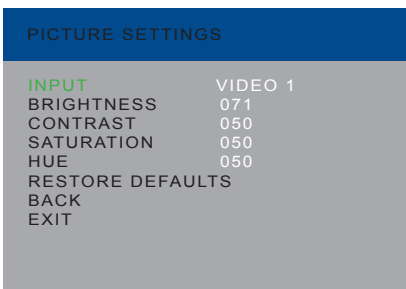

- Press the **Select** button to select the **Input** option. The currently selected input will be highlighted in orange.
- Select the desired input using the ◀ or ▶ buttons.

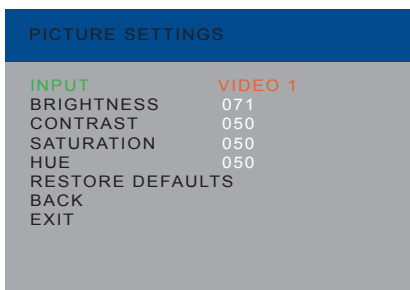

- Press the **Select** button to accept the current input selection.
- Use the ▲ or ▼ buttons to highlight the **Contrast** option.
- Press the **Select** button to select the **Contrast** option.
- Change the contrast value using the ◀ or ▶ buttons.

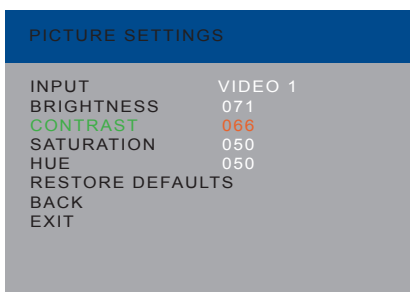

- Press the **Select** button to accept the change.

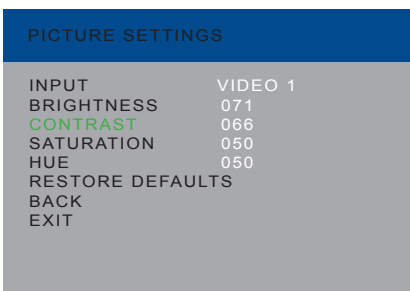

## Adjusting the Saturation

1. Press the **Menu** button on the front panel or on the IR remote control. The menu system will be displayed.

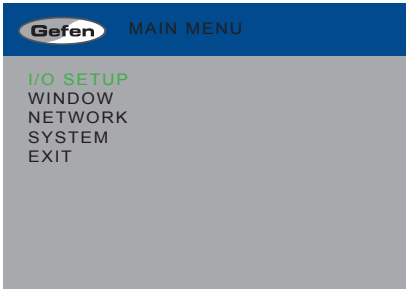

2. Press the **Select** button to display the **Setup Menu**. If using the IR remote, press the **OK** button.
3. Use the **▲** or **▼** buttons to highlight **Picture Settings**.

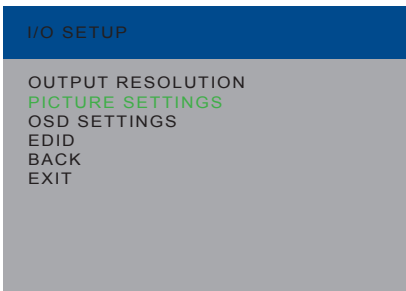

4. Press the **Select** button to display the **Picture Settings** menu. If using the IR remote, press the **OK** button.
5. The **Input** option should be highlighted. If not, use the **▲** or **▼** buttons to highlight it. Each input can have individual contrast settings. Therefore, the input must be selected before making changes to it.

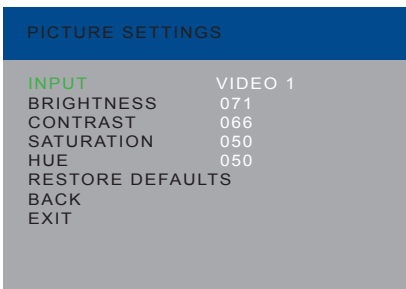

- Press the **Select** button to select the **Input** option. The currently selected input will be highlighted in orange.
- Select the desired input using the ◀ or ▶ buttons.

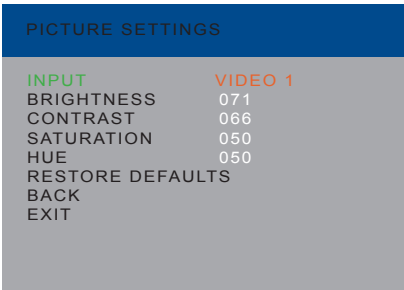

- Press the **Select** button to accept the current input selection.
- Use the ▲ or ▼ buttons to highlight the **Saturation** option.
- Press the **Select** button to select the **Saturation** option.
- Change the saturation value using the ◀ or ▶ buttons.

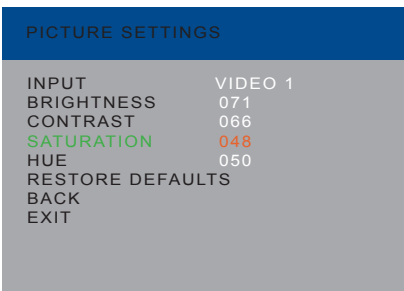

- Press the **Select** button to accept the change.

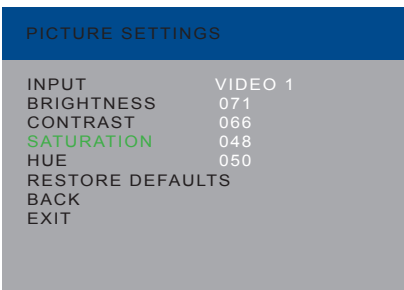

## Adjusting the Hue

1. Press the **Menu** button on the front panel or on the IR remote control. The menu system will be displayed.

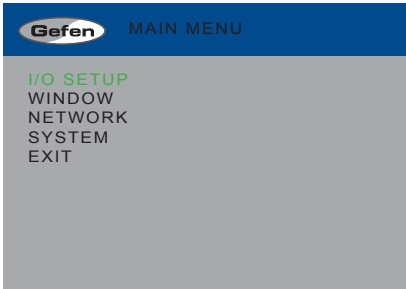

2. Press the **Select** button to display the **Setup Menu**. If using the IR remote, press the **OK** button.
3. Use the **▲** or **▼** buttons to highlight **Picture Settings**.

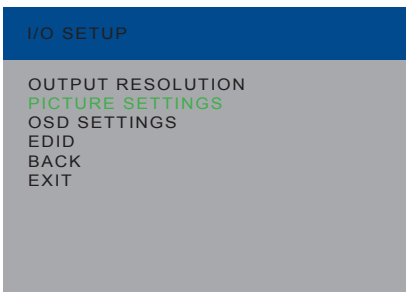

4. Press the **Select** button to display the **Picture Settings** menu. If using the IR remote, press the **OK** button.
5. The **Input** option should be highlighted. If not, use the **▲** or **▼** buttons to highlight it. Each input can have individual contrast settings. Therefore, the input must be selected before making changes to it.

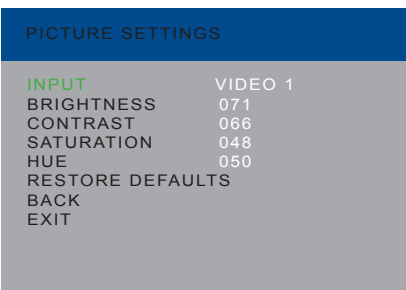

6. Press the **Select** button to select the **Input** option. The currently selected input will be highlighted in orange.
7. Select the desired input using the ◀ or ▶ buttons.

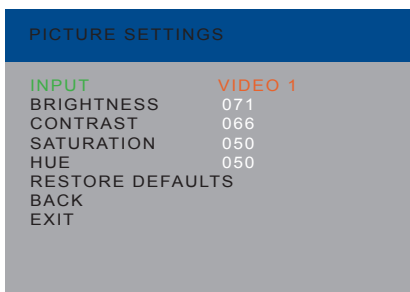

8. Press the **Select** button to accept the current input selection.
9. Use the ▲ or ▼ buttons to highlight the **Hue** option.
10. Press the **Select** button to select the **Hue** option.
11. Change the hue value using the ◀ or ▶ buttons.

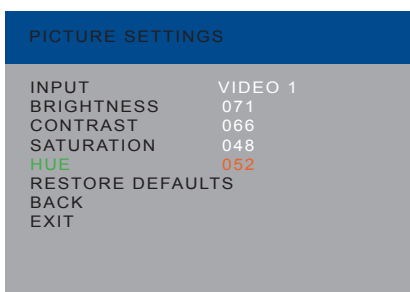

12. Press the **Select** button to accept the change.

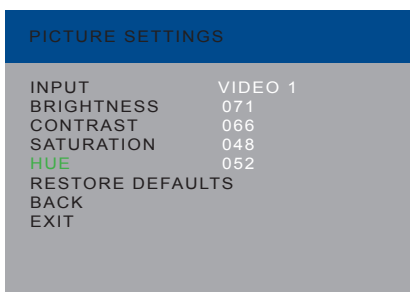

## OSD Settings

The OSD Settings menu controls how the OSD is displayed.

1. Press the **Menu** button on the front panel or on the IR remote control. The menu system will be displayed.

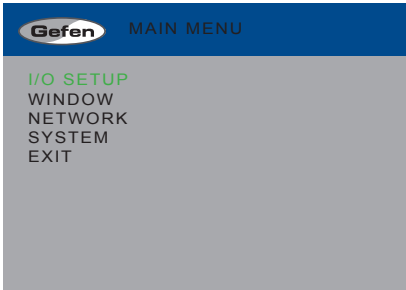

2. Press the **Select** button. If using the IR remote, press the **OK** button.
3. Use the **▲** or **▼** buttons to highlight **OSD Settings**.

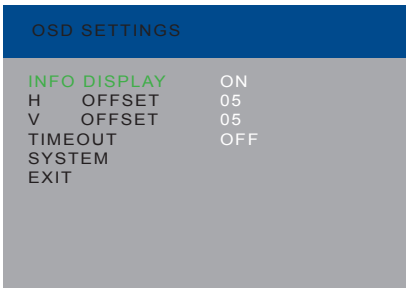

4. Once the desired option is highlighted, press the **Select** button to select it. If using the IR remote control, press the **OK** button.

When an option is selected, its current value will be highlighted in orange.

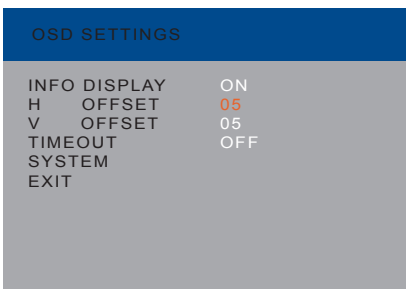



5. Use the ◀ or ▶ buttons to change the current value.
6. Press the **Select** button to accept the current changes. If using the IR remote control, press the **OK** button.

### Info Display

If this option is turned **On**, then the status window is activated.

### H Offset

The horizontal offset of the OSD, as it appears on the display.



## V Offset

The vertical offset of the OSD, as it appears on the display.

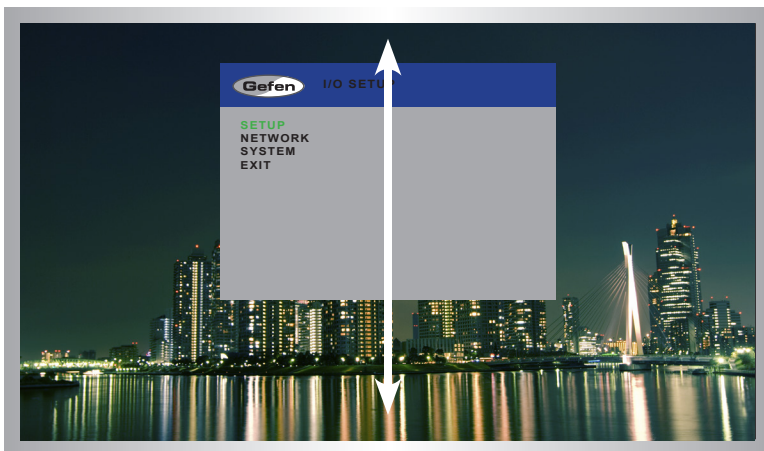

## Timeout

Once the **Menu** button is pressed, the OSD will appear. Timeout is the duration, in seconds, when the OSD will be automatically dismissed. If set to **Off**, then the OSD must be hidden manually by pressing the **Menu** button.

## EDID Management

1. Press the **Menu** button on the front panel or on the IR remote control. The menu system will be displayed.

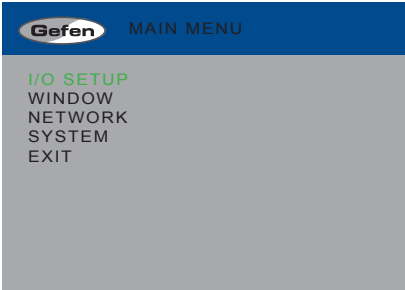

2. Press the **Select** button. If using the IR remote, press the **OK** button.
3. Use the **▲** or **▼** buttons to highlight the **EDID** option.

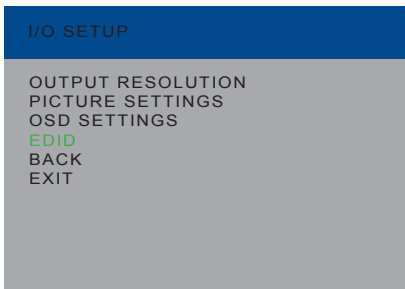

4. Press the **Select** button to display the EDID menu. If using the IR remote, press the **OK** button.

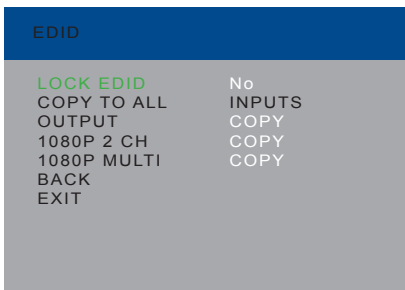

5. Press the **Select** button to select the **Lock EDID** option.
6. Use the ◀ or ▶ buttons to change the value of the **Lock EDID** option.
7. Press the **Select** button to accept the **Lock EDID** value.

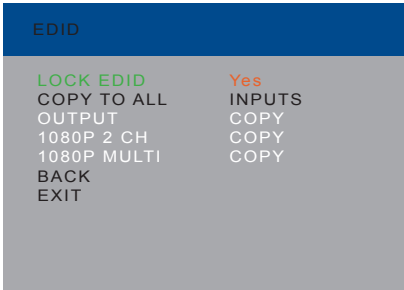

### Selecting an EDID

1. Make sure the **Lock EDID** option is set to **No**.
2. Use the ▲ or ▼ buttons to highlight the desired output, containing the EDID to be copied to the input. The **1080p 2 Ch** or **1080p Multi Ch** EDID can also be selected.

When selecting an EDID, make sure that all displays can support the same audio and video capabilities

3. Press the **Select** button to accept the current output selection. If using the IR remote, press the **OK** button.

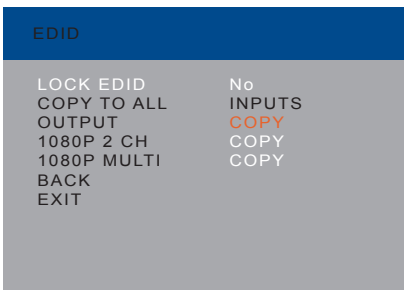

4. The display will flash momentarily. The EDID from the selected output will be copied to the input and will be used by all outputs.

## Mirror

Applies a horizontal transformation (rotated 180° about the y-axis) to window output A.

1. Press the **Menu** button on the front panel or on the IR remote control. The menu system will be displayed.

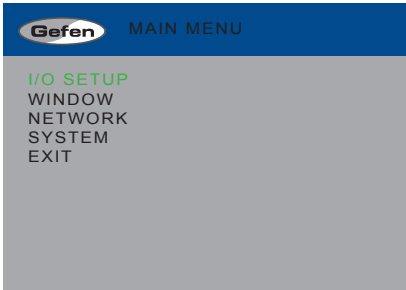

2. Use the ▲ or ▼ buttons to highlight **Window**.
3. Press the **Select** button to display the **Window Settings** menu. If using the IR remote, press the **OK** button.

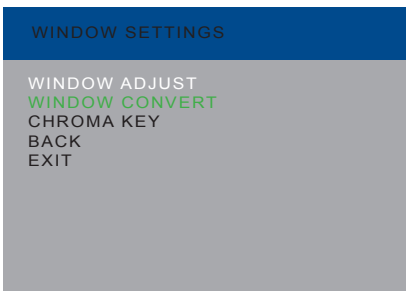

4. Use the ▲ or ▼ buttons to highlight **Window Convert**.
5. Press the **Select** button to display the **Window Convert** menu. If using the IR remote, press the **OK** button.

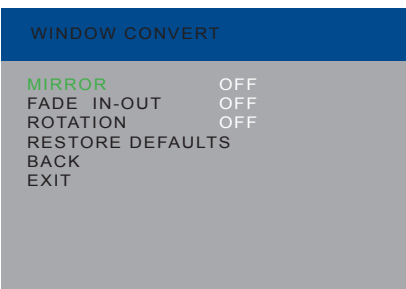

- Press the **Select** button to select the **Mirror** option. The currently selected value will be highlighted in orange.

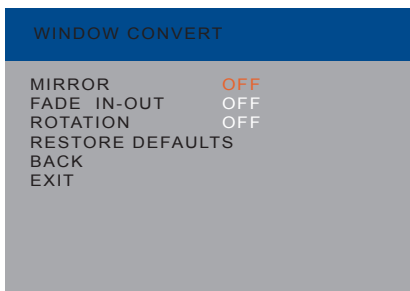

- Use the ◀ or ▶ buttons to switch mirroring On or Off.

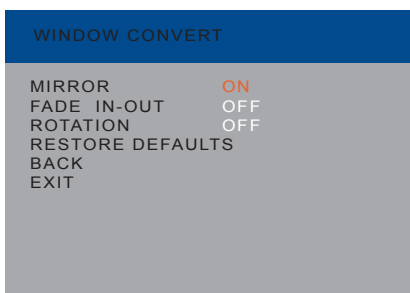

- Press the **Select** button to accept the current changes. If using the IR remote, press the **OK** button.

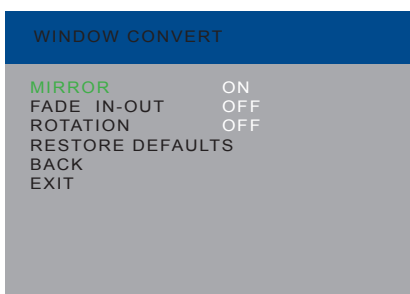

## Fade In-Out

Adds a 1 second transition to Window A and another window, when switching between windows.

1. Press the **Menu** button on the front panel or on the IR remote control. The menu system will be displayed.

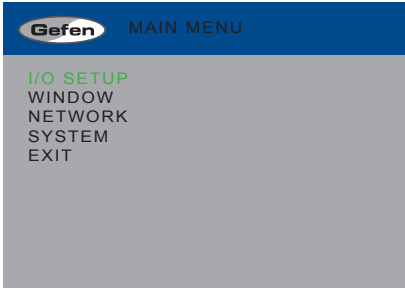

2. Use the ▲ or ▼ buttons to highlight **Window**.
3. Press the **Select** button to display the **Window Settings** menu. If using the IR remote, press the **OK** button.

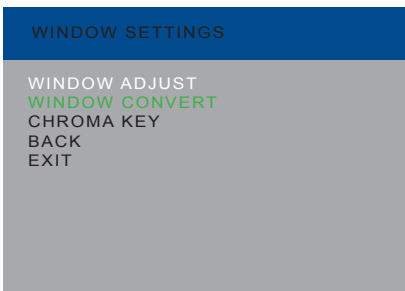

4. Use the ▲ or ▼ buttons to highlight **Window Convert**.
5. Press the **Select** button to display the **Window Convert** menu. If using the IR remote, press the **OK** button.

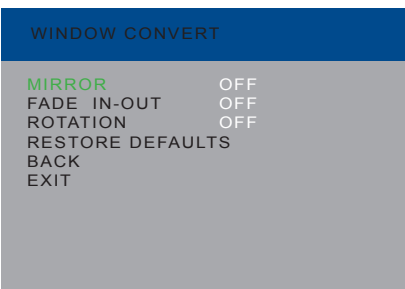

- Use the ▲ or ▼ buttons to highlight **Fade In-Out**.
- Press the **Select** button to select the **Fade In-Out** option. The currently selected value will be highlighted in orange.

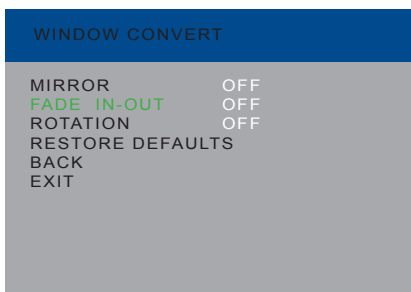

- Use the ◀ or ▶ buttons to switch the fade feature On or Off.

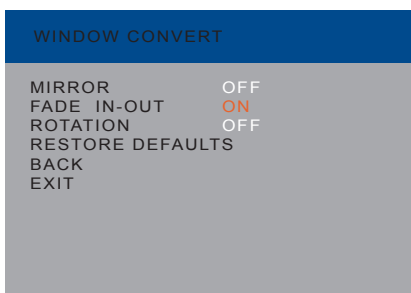

- Press the **Select** button to accept the current changes. If using the IR remote, press the **OK** button.

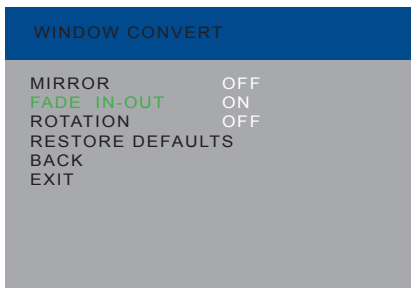



## Chroma Key

See [Using Chroma Key](#) for more information about the chroma key process.

1. Press the **Menu** button on the front panel or on the IR remote control. The menu system will be displayed.

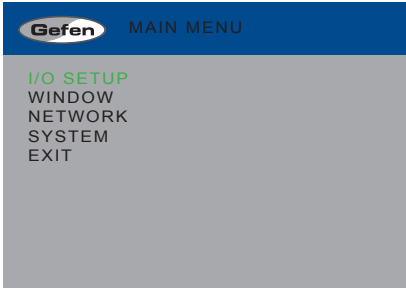

2. Use the ▲ or ▼ buttons to highlight **Window**.
3. Press the **Select** button to display the **Window Settings** menu. If using the IR remote, press the **OK** button.

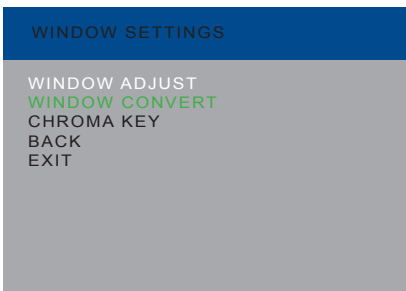

4. Use the ▲ or ▼ buttons to highlight **Chroma Key**.
5. Press the **Select** button to display the **Chroma Key** menu. If using the IR remote, press the **OK** button.

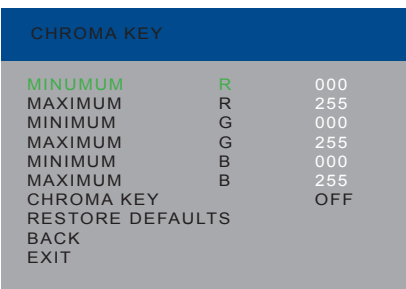

6. Use the ▲ or ▼ buttons to highlight the **Minimum R** option.
7. Press the **Select** button to select the **Minimum R** option. The currently selected value will be highlighted in orange.

CHROMA KEY		
MINIMUM	R	000
MAXIMUM	R	255
MINIMUM	G	000
MAXIMUM	G	255
MINIMUM	B	000
MAXIMUM	B	255
CHROMA KEY		OFF
RESTORE DEFAULTS		
BACK		
EXIT		

8. Use the ◀ or ▶ buttons to change the current value.
9. Press the **Select** button to accept the current changes. If using the IR remote, press the **OK** button.
10. Repeat this process for each of the Maximum and Minimum R, G, and B values.
11. Highlight and select the **Chroma Key** option
12. Use the ◀ or ▶ buttons to turn chroma keying On or Off.

CHROMA KEY		
MINIMUM	R	000
MAXIMUM	R	064
MINIMUM	G	048
MAXIMUM	G	128
MINIMUM	B	064
MAXIMUM	B	128
CHROMA KEY		ON
RESTORE DEFAULTS		
BACK		
EXIT		

13. Press the **Select** button to accept the current changes. If using the IR remote, press the **OK** button.

## Changing the IP Settings

1. Press the **Menu** button on the front panel or on the IR remote control. The menu system will be displayed.
2. Use the **▲** or **▼** buttons to highlight the **Network** option.

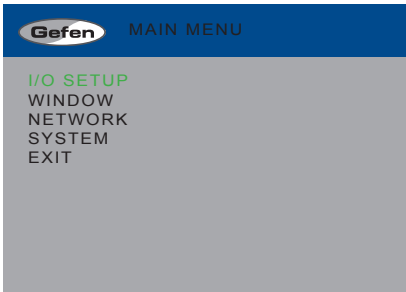

3. Press the **Select** button to display the **Network** menu. If using the IR remote, press the **OK** button.

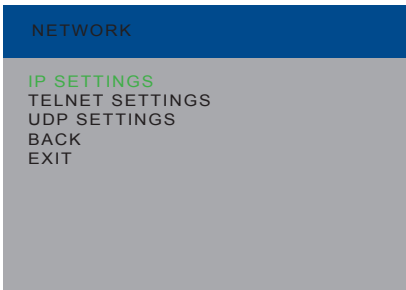

4. Press the **Enter** button again to display the **IP Settings** menu. If using the IR remote, press the **OK** button.

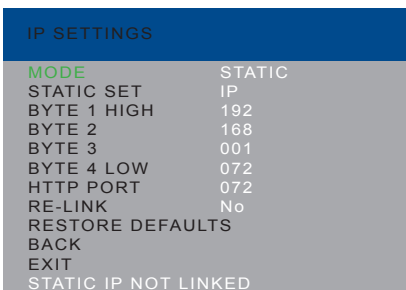

- Use the ▲ or ▼ buttons to highlight the option to change. The **Mode** option will be highlighted, automatically.
- Once the desired option is highlighted, press the **Select** button to select it. If using the IR remote control, press the **OK** button.

When an option is selected, its current value will be highlighted in orange.

IP SETTINGS	
MODE	STATIC
STATIC SET	IP
BYTE 1 HIGH	192
BYTE 2	168
BYTE 3	001
BYTE 4 LOW	072
HTTP PORT	072
RE-LINK	No
RESTORE DEFAULTS	
BACK	
EXIT	
STATIC IP NOT LINKED	

- Use the ◀ or ▶ buttons to change the current value.
- Press the **Select** button to accept the current changes. If using the IR remote control, press the **OK** button.

### Mode

Set this option to either Static or DHCP. If using the Static option, the IP address must be specified. Use the Byte 1 High, Byte 2, Byte 3, and Byte 4 Low options to set each of the digits in the IP address, subnet mask, and gateway.

### Static Set

Use this option to switch between the IP address (IP), subnet mask (Mask), and gateway (Gate).

### Byte

Use the Byte 1 High, Byte 2, Byte 3, and Byte 4 Low options to set each of the digits in the IP address, subnet mask, and gateway.

### HTTP Port

Sets the HTTP listening port for the 4x1 Multiview Seamless Switcher for HDMI.

NETWORK	
MODE	STATIC
STATIC SET	IP
BYTE 1 HIGH	192
BYTE 2	168
BYTE 3	001
BYTE 4 LOW	072
HTTP PORT	072
RE-LINK	No
RESTORE DEFAULTS	
BACK	
EXIT	
STATIC IP NOT LINKED	

### Re-link

Use this option to attempt to re-link to the network using the current IP settings.

### Restore Defaults

This option will reset the default IP settings for the 4x1 Multiview Seamless Switcher for HDMI.

## Changing the Telnet Settings

1. Press the **Menu** button on the front panel or on the IR remote control. The menu system will be displayed.
2. Use the **▲** or **▼** buttons to highlight the **Network** option.

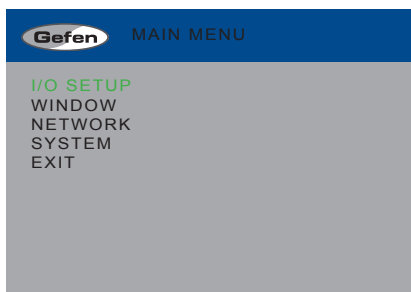

3. Press the **Select** button to display the **Network** menu. If using the IR remote, press the **OK** button.
4. Use the **▲** or **▼** buttons to highlight the **Telnet Settings** option.

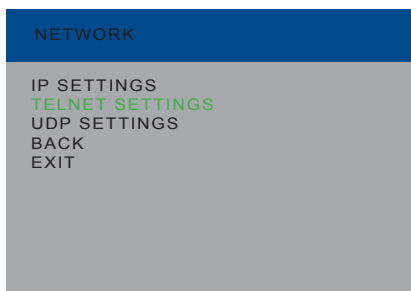

5. Press the **Enter** button again to display the **Telnet Settings** menu. If using the IR remote, press the **OK** button.

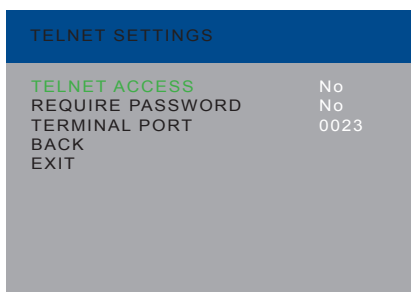

5. Use the ▲ or ▼ buttons to highlight the option to change. The **Telnet Access** option will be highlighted, automatically.
6. Once the desired option is highlighted, press the **Select** button to select it. If using the IR remote control, press the **OK** button.

When an option is selected, its current value will be highlighted in orange.

TELNET SETTINGS	
TELNET ACCESS	No
REQUIRE PASSWORD	No
TERMINAL PORT	0023
BACK	
EXIT	

7. Use the ◀ or ▶ buttons to change the current value.
8. Press the **Select** button to accept the current changes. If using the IR remote control, press the **OK** button.

### Telnet Access

Enables (Yes) or disables (No) Telnet access for the 4x1 Multiview Seamless Switcher for HDMI.

### Require Password

Enables (Yes) or disables (No) the password prompt at the beginning of a Telnet session.

### Terminal Port

Sets the Telnet listening port for the 4x1 Multiview Seamless Switcher for HDMI.

## Changing the UDP Settings

1. Press the **Menu** button on the front panel or on the IR remote control. The menu system will be displayed.
2. Use the **▲** or **▼** buttons to highlight the **Network** option.

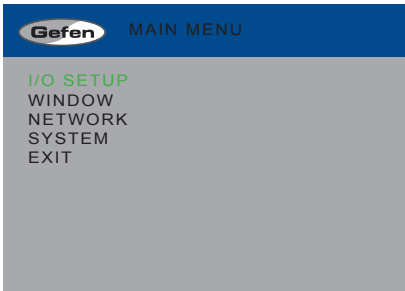

3. Press the **Select** button to display the **Network** menu. If using the IR remote, press the **OK** button.
4. Use the **▲** or **▼** buttons to highlight the **UDP Settings** option.

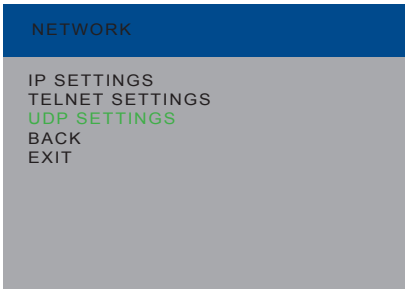

5. Press the **Enter** button again to display the **UDP Settings** menu. If using the IR remote, press the **OK** button.

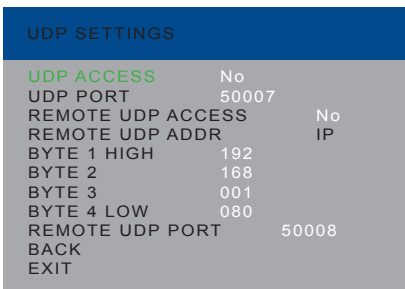



5. Use the ▲ or ▼ buttons to highlight the option to change. The **UDP Access** option will be highlighted, automatically.
6. Once the desired option is highlighted, press the **Select** button to select it. If using the IR remote control, press the **OK** button.

When an option is selected, its current value will be highlighted in orange.

UDP SETTINGS			
UDP ACCESS	No		
UDP PORT	50007		
REMOTE UDP ACCESS	No		
REMOTE UDP ADDR	IP		
BYTE 1 HIGH	192		
BYTE 2	168		
BYTE 3	001		
BYTE 4 LOW	080		
REMOTE UDP PORT	50008		
BACK			
EXIT			

7. Use the ◀ or ▶ buttons to change the current value.
8. Press the **Select** button to accept the current changes. If using the IR remote control, press the **OK** button.

### UDP Access

Enables or disables UDP access to the 4x1 Multiview Seamless Switcher for HDMI.

### UDP Port

Sets the UDP port for the 4x4 Seamless Matrix for HDMI.

### Remote UDP Access

Enables or disables remote UDP access for the 4x1 Multiview Seamless Switcher for HDMI.

### Remote UDP Addr

Sets the remote UDP IP address for the 4x1 Multiview Seamless Switcher for HDMI.

UDP SETTINGS			
UDP ACCESS	No		
UDP PORT	50007		
REMOTE UDP ACCESS		No	
REMOTE UDP ADDR		IP	
BYTE 1 HIGH	192		
BYTE 2	168		
BYTE 3	001		
BYTE 4 LOW	080		
REMOTE UDP PORT	50008		
BACK			
EXIT			

### Byte

Use the Byte 1 High, Byte 2, Byte 3, and Byte 4 Low options to set the IP address of the digits in the UDP IP address, subnet mask, and gateway.

### Remote UDP Port

Sets the remote UDP listening port for the 4x1 Multiview Seamless Switcher for HDMI.

## System Settings

1. Press the **Menu** button on the front panel or on the IR remote control. The menu system will be displayed.
2. Use the **▲** or **▼** buttons to highlight the **System** option.

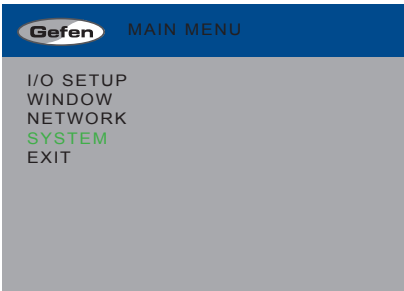

3. Press the **Select** button to display the **System** menu. If using the IR remote, press the **OK** button.

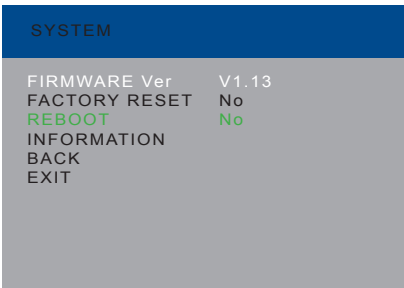

4. Use the **▲** or **▼** buttons to highlight the desired option.
5. Press the **Select** button to make the selection. If using the IR remote control, press the **OK** button.

Selecting **Factory Reset** will reset the 4x1 Multiview Seamless Switcher to factory-default settings

Selecting **Reboot** will reboot the 4x1 Multiview Seamless Switcher. This option is the same as disconnecting and reconnecting the AC power cord, on the back of the switcher.



# Multiview Seamless Switcher

## 03 Advanced Operation

RS-232 and IP Configuration .....	68
RS-232 Interface .....	68
RS-232 Settings .....	68
IP / UDP Configuration .....	69
Commands .....	70
Web Interface .....	148
Using the built-in Web Interface .....	148
Main ▶ Routing .....	149
Main ▶ I/O Status .....	157
Main ▶ Display Info .....	159
I/O Setup ▶ Settings .....	160
I/O Setup ▶ HPD Control .....	162
I/O Setup ▶ HDCP .....	163
Window Setup .....	165
Presets .....	168
EDID ▶ Assign .....	170
EDID ▶ Bank Names .....	174
EDID ▶ Upload / Download .....	175
Network .....	177
System .....	181

# RS-232 and IP Configuration

## RS-232 Interface

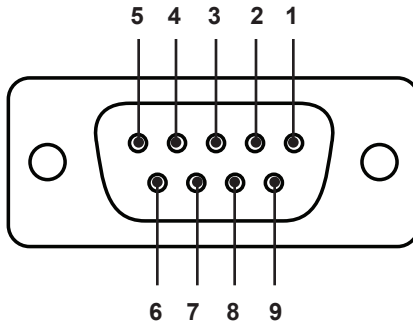

RS-232 Controller

Switcher

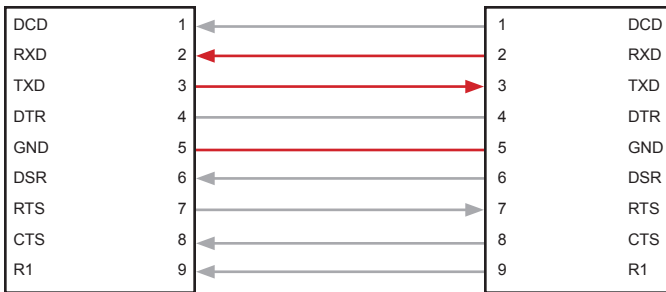

Only TXD, RXD, and GND pins are used.

## RS-232 Settings

Description	Setting
Baud rate	19200
Data bits	8
Parity	None
Stop bits	1
Hardware flow control	None



**IMPORTANT:** When sending Telnet or RS-232 commands, a carriage return (0d) and a line feed (0a) must be included at the end of the command.

## IP / UDP Configuration

The 4x1 Multiview Seamless Switcher for HDMI supports IP-based control using Telnet, UDP, or the built-in Web-based GUI. To set up IP control, the network settings for the 4x1 Multiview Seamless Switcher for HDMI must be configured via RS-232. The default network settings for the 4x1 Multiview Seamless Switcher for HDMI are as follows:

Description	IP Address / Port	Description	IP Address / Port
IP Address	192.168.1.72	UDP Port	23
Subnet	255.255.255.0	Local UDP Port	50007
Gateway	192.168.1.254	Remote UDP IP	192.168.1.255
HTTP Port	80	Remote UDP Port	50008

1. Connect an RS-232 cable from the PC to the 4x1 Multiview Seamless Switcher for HDMI. Also make sure that an Ethernet cable is connected between the 4x1 Multiview Seamless Switcher for HDMI and the network.
2. Launch a terminal emulation program (e.g. HyperTerminal) and use the RS-232 settings listed on the previous page.



**NOTE:** Depending upon the network, all related IP, Telnet, and UDP settings will need to be assigned. Consult your network administrator to obtain the proper settings.

3. Set the IP address for the 4x1 Multiview Seamless Switcher for HDMI using the `#set_ipadd` command.
4. Set the subnet mask using the `#set_netmask` command.
5. Set the gateway (router) IP address using the `#set_gateway` command.
6. Set the Telnet listening port using the `#set_telnet_port` command.
7. Set the HTTP listening port using the `#set_http_port` command.
8. Set the UDP remote IP address for the switcher using the `#set_udp_remote_ip` command.
9. Set the UDP listening port for the switcher using the `#set_udp_port` command.
10. Set the UDP remote port for the switcher using the `#set_udp_remote_port` command.
11. Reboot the switcher to apply all changes, then type the IP address that was specified in step 3, in a Web browser to access the Web GUI. Use the same IP address to Telnet to the switcher.

# Commands

Command	Description
#chromakey	Enables or disables chroma-keying
#chromakey_color	Sets the RGB color range for the chroma key
#display_telnet_welcome	Enables or disables the Telnet welcome message
#fade	Enable or disable fade effect
#fadefault	Resets the current routing and masking state to factory-default settings
#help	Displays the list of available commands
#hdp_pulse	Cycles the HPD line on the specified input
#lock_aspect	Locks the aspect ratio of all inputs
#lock_edid	Locks the local EDID when the switcher is power-cycled
#lock_matrix	Locks or unlocks the switcher
#mask	Masks the specified outputs
#mirror	Enables or disables window mirroring
#mute	Enables or disables muting on all outputs
#power	Toggles the power on the switcher
#reboot	Reboots the switcher
#recall_preset	Loads the specified routing preset into memory
#reset_picture	Resets picture settings to factory-default
#rotate	Rotates the output video signal
#save_preset	Saves a routing preset to memory
#set_audio	Sets the audio input
#set_bank_name	Assigns a name to the specified bank
#set_brightness	Sets the brightness level for all outputs
#set_contrast	Sets the contrast level for all outputs
#set_device_descr	Sets the name of the switcher
#set_edid	Assigns the specified EDID to an input or bank
#set_gateway	Sets the gateway address
#set_hdcp	Enables or disables HDCP detection
#set_hposition	Sets the horizontal position of the specified window
#set_hsize	Sets the horizontal size of the specified window
#set_http_port	Sets the HTTP listening port
#set_hue	Sets the hue for all outputs
#set_ipadd	Sets the IP address
#set_ipmode	Sets the IP mode (DHCP or static)



Command	Description
#set_ir	Sets the IR channel of the switcher
#set_netmask	Sets the subnet mask
#set_osd	Enables or disables the OSD (On-Screen Display)
#set_output	Sets the output resolution
#set_preset_name	Assigns a name to the specified preset
#set_priority	Sets the priority for the specified window
#set_saturation	Set the saturation for the specified output
#set_telnet_pass	Sets the Telnet password
#set_telnet_port	Sets the Telnet listening port
#set_telnet_user	Sets the Telnet user name
#set_udp_port	Sets the local UDP listening port
#set_udp_remote_ip	Sets the remote UDP IP address
#set_udp_remote_port	Sets the remote UDP port
#set_vposition	Sets the vertical position of the specified window
#set_vsize	Sets the vertical size of the specified window
#set_webui_ad_pass	Sets the Administrator password for the Web interface
#set_webui_op_pass	Sets the Operator password for the Web interface
#show_bank_name	Displays the name of the specified EDID bank
#show_brightness	Displays the brightness value for all outputs
#show_chromakey_color	Displays the minimum or maximum value of the specified chroma key color component
#show_contrast	Displays the contrast value for all outputs
#show_device_descr	Displays the IP address of the (router) gateway
#show_hdcp	Displays the HDCP status of the specified input
#show_http_port	Displays the Web server listening port
#show_hue	Displays the hue value for all outputs
#show_ip	Displays the current IP address of the switcher
#show_ipconfig	Displays the current TCP/IP settings of the switcher
#show_ipmode	Displays the current IP mode (DHCP or static)
#show_ir	Displays the current IR channel of the switcher
#show_mac_addr	Displays the MAC address of the switcher
#show_netmask	Displays the current subnet mask
#show_osd	Enables or disables the OSD (On-Screen Display)
#show_output	Displays the output resolution
#show_power	Displays the power state of the switcher

Command	Description
#show_preset_name	Displays the name of the specified preset
#show_saturation	Displays the saturation value for all outputs
#show_tcp_access	Displays the current TCP access state
#show_telnet_port	Displays the current Telnet port
#show_udp_port	Displays the current UDP serial port
#show_udp_remote_ip	Displays the current UDP remote IP address
#show_udp_remote_port	Displays the current UDP remote port
#show_ver_data	Displays the current hardware and software version
#unmask	Disables masking on the specified output
#use_tcp_access	Enables or disables Telnet access
#use_telnet_pass	Forces password credentials for each Telnet session
#use_udp_access	Enables or disables UDP access
m	Displays the switcher routing status
r	Routes the specified input to the output
s	Routes the specified input to all outputs

## #chromakey

The #chromakey command enables or disables chroma-keying. This command is only applicable when viewing a single input (full screen). Executing this command when viewing multiple windows will return an error.

### Syntax

```
#chromakey param1
```

### Parameters

*param1* Value [0 ... 1]

Value	Description
0	Disable
1	Enable

### Examples

```
#chromakey 1  
CHROMAKEY EFFECT ON
```

If command is run when viewing multiple windows:

```
#chromakey 1  
CURRENT ROUTING STATE IS WRONG!
```

## #chromakey\_color

The #chromakey\_color command sets the RGB color range for the chroma key. See [Using Chroma Key](#) for more information using this feature.

### Syntax

```
#chromakey_color param1 param2 param3
```

### Parameters

*param1* Color channel [CHAR]

Value	Description
r	Red channel
g	Green channel
b	Blue channel

*param2* Color range [STRING]

Value	Description
min	Minimum value
max	Maximum value

*param3\** Value [0 ... 15]

Value	Min	Max
0	0	15
1	16	31
2	32	47
3	48	63
4	64	79
5	80	95

\*If *param2* = min, then value under the Min column will be used. If *param2* = max, then get the value under the Max column.

(continued on next page)

Value	Min	Max
6	96	111
7	112	127
8	128	143
9	144	159
10	160	175
11	176	191
12	192	207
13	208	223
14	224	239
15	240	255

### Examples

```
#chromakey_color r min 2  
CHROMA KEY VALUE FOR R MIN SET TO 32
```

```
#chromakey_color r max 14  
CHROMA KEY VALUE FOR R MAX SET TO 239
```

## #display\_telnet\_welcome

The #display\_telnet\_welcome command enables or disables the Telnet welcome message during a Telnet session.

### Syntax

```
#display_telnet_welcome param1
```

### Parameters

*param1* Value [0 ... 1]

Value	Description
0	Disable welcome message
1	Enable welcome message

### Example

```
#display_telnet_welcome 1
TELNET WELCOME SCREEN IS ENABLED
```

When enabled and a Telnet session has been started, the following will appear:

```
Welcome to EXT-HD-MVSL-441 TELNET
```

## #fade

The #fade command enables or disables fade effects.

### Syntax

```
#fade param1
```

### Parameters

*param1*

Value

[0 ... 1]

Value	Description
0	Disable fade effects
1	Enable fade effects

### Example

```
#fade 1  
FADE EFFECT ON
```

## #fadefault

The #fadefault command resets the 4x1 Multiview Seamless Switcher for HDMI to factory-default settings. Outputs are unmasked and all IP and UDP settings are reset to default settings.

### Syntax

```
#fadefault
```

### Parameters

*None*

### Example

```
#fadefault
```



## #help

The #help command displays the list of available RS-232 / Telnet commands. Help on a specific command can be displayed when using `param1`.

### Syntax

```
#help param1
```

### Parameters

<i>param1</i>	Command name (optional)	[STRING]
---------------	-------------------------	----------

### Example

```
#help #sipadd
SET IP ADDRESS
#SIPADD PARAM1
PARAM1 = XXX.XXX.XXX.XXX
WHERE XXX: 0 - 255
```

## #hdp\_pulse

The #hdp\_pulse command cycles the HPD line on the specified input. Issuing this command is identical to physically disconnecting and reconnecting the cable between the source and the matrix. If *param1* = 0, then an HPD pulse is sent to all inputs.

### Syntax:

```
#hdp_pulse param1
```

### Parameters:

<i>param1</i>	Input	[1 ... 4]
---------------	-------	-----------

### Examples:

```
#hdp_pulse 1  
HPD PULSE HAS BEEN SENT TO INPUT 1
```

## #lock\_aspect

The #lock\_aspect command locks or unlocks the aspect ratio of all inputs. This command is only applicable when viewing multiple input (multiple windows). Executing this command when viewing a single window will return an error.

### Syntax

```
#lock_aspect param1
```

### Parameters

*param1* Value [0 ... 1]

Value	Description
0	Unlock
1	Lock

### Example

```
#lock_aspect 1  
ASPECT RATIO LOCKED
```

If command is run when viewing a single window:

```
#lock_aspect 1  
CURRENT ROUTING STATE IS WRONG!
```

## #lock\_edid

The #lock\_edid command secures the Local EDID by disabling the automatic loading of the downstream EDID when the switcher is powered.

### Syntax

```
#lock_edid param1
```

### Parameters

*param1* Value [0 ... 1]

Value	Description
0	Unlock EDID
1	Lock EDID

### Example

```
#lock_edid 1  
EDID IS LOCKED
```

## #lock\_matrix

The #lock\_matrix command locks or unlocks the switcher. When the switcher is locked, all functions are disabled including the front panel, RS-232, and Telnet.

### Syntax

```
#lock_matrix param1
```

### Parameters

*param1* Value [0 ... 1]

Value	Description
0	Unlock
1	Lock

### Example

```
#lock_matrix 1  
ALL MATRIX FUNCTIONS IS LOCKED
```

## #mask

The `#mask` command masks the video on the specified window(s). Use the `#unmask` command to disable output masking. If `param1 = 0`, then all outputs are masked.

### Syntax

```
#mask param1
```

### Parameters

<i>param1</i>	Window	[0 ... 4]
---------------	--------	-----------

### Examples

```
#mask 1  
OUTPUT A IS MASKED
```

```
#mask 0  
ALL OUTPUTS ARE MASKED
```

## #mirror

The #mirror command enables or disables window mirroring. This command applies a horizontal transformation (rotated 180° about the y-axis) to window output A.

### Syntax

```
#mirror param1
```

### Parameters

*param1* Value [0 ... 1]

Value	Description
0	Disable
1	Enable

### Example

```
#mirror 1  
MIRROR EFFECT ON
```

## #mute

The #mute command enables or disables audio muting on all outputs.

### Syntax

```
#mute param1
```

### Parameters

*param1*

Value

[0 ... 1]

Value	Description
0	Unlock
1	Lock

### Example

```
#mute 1  
AUDIO IS MUTED
```



## #power

The `#power` command toggles power on the 4x1 Multiview Seamless Switcher for HDMI.

### Syntax

```
#power param1
```

### Parameters

*param1* Value [0 ... 1]

Value	Description
0	Off
1	On

### Examples

```
#power 0  
POWER IS OFF
```

```
#power 1  
POWER IS ON
```

## #reboot

The `#reboot` command reboots the 4x1 Multiview Seamless Switcher for HDMI. Executing this command is the equivalent of disconnecting and reconnecting the AC power cord, on the back of the switcher. The 4x1 Multiview Seamless Switcher for HDMI must be rebooted after changing any of the IP settings.

### Syntax

```
#reboot
```

### Parameters

*None*

### Example

```
#reboot
DEVICE HAS BEEN REBOOTED
IP: 192.168.5.155
Netmask: 255.255.255.0
Gateway: 192.168.5.254
Ethernet Cable Plug in!!
```

## #recall\_preset

The #recall\_preset command loads the routing preset.

### Syntax

```
#recall_preset param1
```

### Parameters

<i>param1</i>	Preset	[1 ... 10]
---------------	--------	------------

### Example

```
#recall_preset 2  
INPUT 4 IS ROUTED TO WINDOW OUTPUT A  
RECALL ROUTING STATE PRESET 2
```

## #reset\_picture

The #reset\_picture command resets all picture settings to factory-default.

### Syntax

```
#reset_picture
```

### Parameters

*None*

### Example

```
#reset_picture  
PICTURE SETTINGS HAVE BEEN SET TO DEFAULTS
```

## #rotate

The `#rotate` command is used to rotate the output image. This command can only be used when using single window mode. See [Single Window Nomenclature](#) for information on using a single window. Set `param1 = 0` to turn off image rotation.

### Syntax

```
#rotate param1
```

### Parameters

*param1* Value [1 ... 3]

Value	Description
1	Right 90°
2	Left 90°
3	180°

### Example

```
#rotate 2  
ROTATE VIDEO SET TO L90
```

## #save\_preset

The `#save_preset` command saves the current routing state to a specified preset.

### Syntax

```
#save_preset param1
```

### Parameters

<i>param1</i>	Preset	[1 ... 10]
---------------	--------	------------

### Example

```
#save_preset 1  
CURRENT ROUTING STATE IS SAVED TO PRESET 1
```

## #set\_audio

The `#set_audio` command sets the audio input.

### Syntax

```
#set_audio param1
```

### Parameters

<i>param1</i>	Audio Input	[1 ... 4]
---------------	-------------	-----------

### Example

```
#set_audio 1  
AUDIO INPUT 1 IS SELECTED
```

## #set\_bank\_name

The #set\_bank\_name command names the specified bank.

### Syntax

```
#set_bank_name param1 param2
```

### Parameters

<i>param1</i>	Bank	[1 ... 8]
<i>param2</i>	Name	[STRING]

### Example

```
#set_bank_name 5 Dell_24  
Dell_24 NAME IS ASSIGNED TO BANK 5
```

## #set\_brightness

The #set\_brightness command sets the brightness level of the video signal on the specified input.

### Syntax

```
#set_brightness param1 param2
```

### Parameters

<i>param1</i>	Input	[1 ... 4]
<i>param2</i>	Level	[0 ... 100]

### Examples

```
#set_brightness 1 65  
INPUT 1 IS SET TO BRIGHTNESS VALUE : 65
```

## #set\_contrast

The `#set_contrast` command sets the contrast level of the video signal on the specified input. If *param1* = 0, then all inputs are affected.

### Syntax

```
#set_contrast param1 param2
```

### Parameters

<i>param1</i>	Input	[1 ... 4]
<i>param2</i>	Level	[0 ... 100]

### Examples

```
#set_contrast 1 74  
INPUT 1 IS SET TO CONTRAST VALUE 74
```



## #set\_device\_descr

The #set\_device\_descr command assigns a name to the switcher. This is useful when there are multiple devices on a network and you want to give them different names (e.g. Conf Rm, Wall Unit 1, etc.) The value of *param1* cannot exceed 12 characters in length. The default name is EXT-HD-MVSL-441.

### Syntax

```
#set_device_descr param1
```

### Parameters

<i>param1</i>	Name	[STRING]
---------------	------	----------

### Examples

```
#set_device_descr WallTwo  
DEVICE DESCRIPTION NAME IS SET TO WallTwo
```

## #set\_edid

The `#set_edid` command sets the specified EDID type to an input or bank. Note that the argument for *param2* is dependent upon the value of *param1*. Similarly, the argument for *param4* is dependent upon the value of *param3*.

### Syntax

```
#set_edid param1 param2 param3 param4
```

### Parameters

*param1* Source [STRING]

Source	Description
int	Uses default (Internal) EDID
bank	Uses EDID bank
output	Uses EDID on Output (sink)

*param2*\* Source [1 ... 8]

Source	Description
1 ... 4	1 = 720p / 2CH 2 = 720p / Multichannel 3 = 1080p / 2CH 4 = 1080p / Multichannel
1 ... 8	EDID bank
1 ... 4	Output

\* When specifying *param2*, the available arguments will depend upon the value of *param1*:

If *param1* = `int`, then *param2* must specify an internal EDID from 1 to 4. If *param1* = `bank`, then *param2* must specify an EDID bank from 1 to 8. If *param1* = `output`, then *param2* must specify an output from 1 to 4.

(continued on next page)

*param3* Target [STRING]

Target	Description
input	Specifies an input
bank	Specifies an EDID bank

*param4*\*\* Target [1 ... 8]

Value	Description
1 ... 4	Input
1 ... 8	EDID bank

\*\* When specifying *param4*, the available arguments will depend upon the value of *param3*:

If *param3* = *input*, then *param4* must be an input from 1 to 4. If *param3* = *bank*, then *param4* must specify an EDID bank from 1 to 8.

## Examples

```
#set_edid int 2 input 4
INTERNAL EDID 2 IS SAVED TO INPUT4
```

```
#set_edid bank 3 bank 5
BANK EDID 3 IS SAVED TO BANK5
```

## #set\_gateway

The #set\_gateway command sets the gateway address. The gateway must be typed using dot-decimal notation. The 4x1 Multiview Seamless Switcher for HDMI must be rebooted after executing this command. The default gateway is 192.168.1.1.

### Syntax

```
#set_gateway param1
```

### Parameters

<i>param1</i>	Gateway
---------------	---------

### Example

```
#set_gateway 192.168.1.5  
GATEWAY : 192.168.1.11
```

## #set\_hdcp

The #set\_hdcp command disables or enables HDCP pass-through on the specified input. If *param2* = 0, then all inputs are affected.

### Syntax

```
#set_hdcp param1 param2 param3
```

### Parameters

*param1* Value [0 ... 1]

Value	Description
0	Input
1	Output

*param2* Value [0 ... 4]

Value	Description
0	All
1	Input 1
2	Input 2
3	Input 3
4	Input 4

*param3* Value [0 ... 1]

Value	Description
0	Accept / Follow Input
1	Not Accept / Always On

(continued on next page)

The meaning of *param3* changes depending upon the value specified by *param1*.

For example, if *param1* = 0, then the HDCP settings will affect the inputs.

Setting *param3* = 0 will result in setting the specified input to "Accept". If *param3* = 1, then the input will be set to "Not Accept"

Conversely, if *param1* = 1, then the HDCP settings will affect the outputs.

Setting *param3* = 0 will result in affecting the outputs: If *param3* = 0, then the specified output will be set to "Follow Input". If *param3* = 1, then the specified input will be set to "Always On".

## Examples

```
#set_hdcp 0 2 1
HDCP SET TO NOT ACCEPT ON INPUT 2
```

```
#set_hdcp 1 1 0
HDCP SET TO FOLLOW INPUT FOR OUTPUT 1
```

```
#set_hdcp 0 0 1
HDCP SET TO NOT ACCEPT ON ALL INPUTS
```

## #set\_hposition

The `#set_hposition` command sets the horizontal position of the specified window. *param2* is the number of horizontal pixels for the resolution of the specified window. This command is only applicable when viewing multiple input (multiple windows). Executing this command when viewing a single window will return an error.

### Syntax

```
#set_hposition param1 param2
```

### Parameters

<i>param1</i>	Window	[1 ... 4]
<i>param2</i>	Horizontal Pixels (active)	[0 ... n]

### Example

```
#set_hposition 1 300  
SET HORIZONTAL POSITION VALUE TO 300 PIXELS FOR WINDOW 1
```

If command is run when viewing a single window:

```
#set_hposition 1 300  
CURRENT ROUTING STATE IS WRONG!
```

## #set\_hsize

The `#set_hsize` command sets the horizontal size of the specified window. *param2* is the number of horizontal pixels for the resolution of the specified window. This command is only applicable when viewing multiple input (multiple windows). Executing this command when viewing a single window will return an error.

### Syntax

```
#set_hsize param1 param2
```

### Parameters

<i>param1</i>	Window	[1 ... 4]
<i>param2</i>	Horizontal Pixels (active)	[0 ... n]

### Example

```
#set_hsize 1 600  
SET HORIZONTAL STRETCH VALUE TO 600 PIXELS FOR WINDOW 1
```

If command is run when viewing a single window:

```
#set_hsize 1 600  
CURRENT ROUTING STATE IS WRONG!
```



## #set\_http\_port

The `#set_http_port` command specifies the Web server listening port. The 4x1 Multiview Seamless Switcher for HDMI must be rebooted after executing this command. The default port setting is 80. Use the `#show_http_port` command to display the current HTTP listening port.

### Syntax

```
#set_http_port param1
```

### Parameters

<i>param1</i>	Port	[1 ... 1024]
---------------	------	--------------

### Example

```
#set_http_port 82  
HTTP PORT 82 IS SET
```

## #set\_hue

The `#set_hue` command sets the hue for the video signal on the specified input. If *param1* = 0, then all inputs are affected.

### Syntax

```
#set_hue param1 param2
```

### Parameters

<i>param1</i>	Input	[1 ... 4]
<i>param2</i>	Value	[0 ... 100]

### Example

```
#set_hue 1 30  
INPUT 1 IS SET TO HUE VALUE 30
```

## #set\_ipadd

The #set\_ipadd command sets the IP address of the 4x1 Multiview Seamless Switcher for HDMI. The IP address must be entered using dot-decimal notation. The switcher must be rebooted after executing this command. The default IP address is 192.168.1.72. Use the #show\_ipconfig or #show\_ip command to display the current IP address of the 4x1 Multiview Seamless Switcher for HDMI.

### Syntax

```
#set_ipadd param1
```

### Parameters

<i>param1</i>	IP address
---------------	------------

### Example

```
#set_ipadd 192.168.1.190  
IP ADDRESS : 192.168.1.190
```

## #set\_ipmode

The #set\_ipmode command sets the IP mode to DHCP or static. The 4x1 Multiview Seamless Switcher for HDMI must be rebooted after executing this command.

### Syntax

```
#set_ipmode param1
```

### Parameters

*param1* Value [0 ... 1]

Value	Description
0	DHCP
1	Static

### Example

```
#set_ipmode 1  
IP MODE SET TO STATIC  
PLEASE REBOOT TO ACTIVATE!!!
```

## #set\_ir

The #set\_ir command sets the IR channel for the switcher. The default IR channel setting is 1. The IR channel for the switcher can also be set under the [System](#) tab within the Web interface.

Both the matrix and the included IR remote control must be set to the same IR channel in order to work properly. To set the IR channel for the included IR remote control, see [Setting the IR Channel](#).

### Syntax

```
#set_ir param1
```

### Parameters

*param1* Channel [0 ... 3]

Value	Description
0	IR channel 0
1	IR channel 1
2	IR channel 2
3	IR channel 3

### Example

```
#set_ir 1  
IR CHANNEL IS SET TO 1
```

## #set\_netmask

The `#set_netmask` command sets the subnet mask. The subnet mask must be entered using dot-decimal notation. The switcher must be rebooted after executing this command. The default subnet mask is 255.255.255.0. Use the `#show_netmask` or `#show_ipconfig` command to display the current subnet mask of the switcher.

### Syntax

```
#set_netmask param1
```

### Parameters

<i>param1</i>	Subnet mask
---------------	-------------

### Example

```
#set_netmask 255.255.255.0  
NETMASK : 255.255.255.0
```

## #set\_osd

The #set\_osd command enables or disables the OSD (On-Screen Display). The OSD is enabled, by default.

### Syntax

```
#set_osd param1
```

### Parameters

*param1* Value [0 ... 1]

Value	Description
0	Disable
1	Enable

### Example

```
#set_osd 0  
OSD IS SET TO OFF
```

## #set\_output

The `#set_output` command sets the output resolution. The specified output resolution is applied to all outputs.

### Syntax

```
#set_output param1
```

### Parameters

*param1*

Value

[1 ... 17]

Value	Description
1	480p
2	576p
3	720p @ 50 Hz
4	720p @ 60 Hz
5	1080p @ 24 Hz
6	1080p @ 50 Hz
7	1080p @ 60 Hz
8	1024 x 768
9	1280 x 800
10	1280 x 1024
11	1366 x 768
12	1440 x 900
13	1600 x 900
14	1600 x 1200
15	1680 x 1050
16	1920 x 1200
17	Native

### Example

```
#set_output 17
OUTPUT RESOLUTION IS SET TO Native 1920x1080P 60HZ
```

## #set\_preset\_name

The `#set_preset_name` command assigns a name to the specified preset. The name of the preset is limited to 8 characters. Names longer than 8 characters will be truncated. To display the name of a preset, use the `#show_preset_name` command. Presets 1 through 5 cannot be changed.

### Syntax

```
#set_preset_name param1 param2
```

### Parameters

<i>param1</i>	Preset	[6 ... 20]
<i>param2</i>	Name	[STRING]

### Example

```
#set_preset_name 8 MyWinCfg  
MyWinCfg NAME IS ASSIGNED TO PRESET 8
```



## #set\_priority

The `#set_priority` command sets the priority for the specified window. Windows assigned with a priority of 1 will appear on top of all other windows. Windows with a priority of 4 will be displayed on the bottom of all other windows. See [Window Priority](#) for more information.

### Syntax

```
#set_priority param1 param2
```

### Parameters

<i>param1</i>	Window	[1 ... 4]
<i>param2</i>	Priority	[1 ... 4]

### Example

```
#set_priority 2 1  
WINDOW 2 SET TO PRIORITY 1
```

## #set\_saturation

The #set\_saturation command sets the color saturation level for the specified input. If *param1* = 0, then all inputs are affected.

### Syntax

```
#set_saturation param1 param2
```

### Parameters

<i>param1</i>	Input	[0 ... 4]
<i>param2</i>	Level	[0 ... 100]

### Example

```
#set_saturation 1 65  
INPUT 1 IS SET TO SATURATION VALUE 65
```

## #set\_telnet\_pass

The #set\_telnet\_pass command sets the Telnet password. The password cannot exceed 10 characters in length.

### Syntax

```
#set_telnet_pass param1
```

### Parameters

<i>param1</i>	Password	[STRING]
---------------	----------	----------

### Example

```
#set_telnet_pass Fl0t111a  
TELNET INTERFACE PASSWORD IS SET Fl0t111a
```

## #set\_telnet\_port

The `#set_telnet_port` command sets the Telnet listening port. The 4x1 Multiview Seamless Switcher for HDMI must be rebooted after executing this command. The default port setting is 23. Use the `#show_telnet_port` command to display the current Telnet listening port.

### Syntax

```
#set_telnet_port param1
```

### Parameters

<i>param1</i>	Port	[1 ... 1024]
---------------	------	--------------

### Example

```
#set_telnet_port 24  
TELNET PORT 24 IS SET
```

## #set\_telnet\_user

The #set\_telnet\_user command creates a Telnet username.

### Syntax

```
#set_telnet_user param1
```

### Parameters

<i>param1</i>	Username	[STRING]
---------------	----------	----------

### Example

```
#set_telnet_user bo55man  
TELNET INTERFACE USERNAME IS SET bo55man
```

## #set\_udp\_port

The #set\_udp\_port command sets the UDP listening port.

### Syntax

```
#set_udp_port param1
```

### Parameters

<i>param1</i>	Port	[1 ... 65535]
---------------	------	---------------

### Example

```
#set_udp_port 1002  
UDP COMMUNICATION PORT 1002 IS SET  
PLEASE REBOOT THE UNITS
```

## #set\_udp\_remote\_ip

The #set\_udp\_remote\_ip command sets the remote UDP IP address. The IP address must be specified using dot-decimal notation. The default UDP remote IP address is 192.168.1.255. The 4x1 Multiview Seamless Switcher for HDMI must be rebooted after executing this command.

### Syntax

```
#set_udp_remote_ip param1
```

### Parameters

<i>param1</i>	UDP address
---------------	-------------

### Example

```
#set_udp_remote_ip 192.168.1.227  
UDP REMOTE IP ADDRESS : 192.168.1.227
```

## #set\_udp\_remote\_port

The `#set_udp_remote_port` command sets the remote UDP listening port. The default remote UDP listening port is 50008. The 4x1 Multiview Seamless Switcher for HDMI must be rebooted after executing this command.

### Syntax

```
#set_udp_remote_port param1
```

### Parameters

<i>param1</i>	Port	[0 ... 65535]
---------------	------	---------------

### Example

```
#set_udp_remote_port 50008
```

```
REMOTE UDP COMMUNICATION PORT 50008 IS SET.
```



## #set\_vposition

The `#set_vposition` command sets the vertical position of the specified window. *param2* is the number of vertical pixels for the resolution of the specified window. This command is only applicable when viewing multiple windows. Executing this command when viewing a single window will return an error.

### Syntax

```
#set_vposition param1 param2
```

### Parameters

<i>param1</i>	Window	[1 ... 4]
<i>param2</i>	Vertical Pixels (active)	[0 ... n]

### Example

```
#set_vposition 2 100  
SET VERTICAL POSITION VALUE TO 100 PIXELS FOR WINDOW 2
```

If command is executed when viewing a single window:

```
#set_vposition 2 100  
CURRENT ROUTING STATE IS WRONG!
```

## #set\_vsize

The `#set_vsize` command sets the vertical size of the specified window. *param2* is the number of vertical pixels for the resolution of the specified window. This command is only applicable when viewing multiple windows. Executing this command when viewing a single window will return an error.

### Syntax

```
#set_vsize param1 param2
```

### Parameters

<i>param1</i>	Window	[1 ... 4]
<i>param2</i>	Vertical Pixels (active)	[0 ... n]

### Example

```
#set_vsize 3 250  
SET VERTICAL STRETCH VALUE TO 250 PIXELS FOR WINDOW 3
```

If command is executed when viewing a single window:

```
#set_vsize 3 250  
SET VERTICAL STRETCH VALUE TO 250 PIXELS FOR WINDOW 3
```

## #set\_webui\_ad\_pass

The #set\_webui\_ad\_pass command sets the Administrator password for the Web GUI. The password is case-sensitive and cannot exceed 8 characters in length. The default password is Admin.

### Syntax

```
#set_webui_ad_pass param1
```

### Parameters

<i>param1</i>	Password
---------------	----------

### Example

```
#set_webui_ad_pass bossman  
WEB UI ADMINISTRATOR PASSWORD IS SET bossman
```

## #set\_webui\_op\_pass

The #set\_webui\_ad\_pass command sets the Operator password for the Web GUI. The default password is Admin.

### Syntax

```
#set_webui_op_pass param1
```

### Parameters

*param1* Password

### Example

```
#set_webui_op_pass minion  
WEB UI OPERATOR PASSWORD IS SET minion
```

## #show\_audio

The #show\_audio command displays the current audio source. Use the #set\_audio command to set the audio source.

### Syntax

```
#show_audio
```

### Parameters

*None*

### Example

```
#show_audio  
AUDIO SOURCE 1 IS SELECTED
```

## #show\_bank\_name

The #show\_bank\_name command displays the name of the specified EDID bank. To assign a name to an EDID bank, use the #set\_bank\_name command.

### Syntax

```
#show_bank_name param1
```

### Parameters

<i>param1</i>	Bank	[1 ... 8]
---------------	------	-----------

### Example

```
#show_bank_name 5  
THE NAME FOR BANK5 IS : Dell24
```

## #show\_brightness

The #show\_brightness command displays the brightness level for the specified input. If *param1* = 0, then the brightness value for all inputs are returned.

### Syntax

```
#show_brightness param1
```

### Parameters

*None*

### Examples

```
#show_brightness 1  
INPUT 1 IS SET TO BRIGHTNESS VALUE 65
```

```
#show_brightness 0  
INPUT 1 IS SET TO BRIGHTNESS VALUE 65  
INPUT 2 IS SET TO BRIGHTNESS VALUE 50  
INPUT 3 IS SET TO BRIGHTNESS VALUE 50  
INPUT 4 IS SET TO BRIGHTNESS VALUE 50
```

## #show\_chromakey\_color

The `#show_chromakey_color` command displays the minimum or maximum value of the specified chroma key color component.

### Syntax

```
#show_chromakey_color param1 param2
```

### Parameters

*param1* Color channel [CHAR]

Value	Description
r	Red channel
g	Green channel
b	Blue channel

*param2* Color range [STRING]

Value	Description
min	Minimum value
max	Maximum value

### Example

```
#show_chromakey_color r max
CHROMA KEY VALUE FOR R MAX SET TO 15
```

## #show\_contrast

The `#show_contrast` command displays the contrast level for the specified input. If `param1 = 0`, then the contrast value for all inputs are returned.

### Syntax

```
#show_contrast param1
```

### Parameters

<code>aparam1</code>	Input	[0 ... 4]
----------------------	-------	-----------

### Example

```
#show_contrast 1
INPUT 1 IS SET TO CONTRAST VALUE 74

#show_contrast 0
INPUT 1 IS SET TO CONTRAST VALUE 74
INPUT 2 IS SET TO CONTRAST VALUE 50
INPUT 3 IS SET TO CONTRAST VALUE 50
INPUT 4 IS SET TO CONTRAST VALUE 50
```

## #show\_device\_descr

The `#show_device_descr` command displays the device description. Use the `#set_device_descr` command to assign the device description.

### Syntax:

```
#show_device_descr
```

### Parameters:

None

### Example:

```
#show_device_descr
DEVICE DESCRIPTION NAME IS SET TO WallTwo
```



## #show\_discovery

The #show\_discovery command displays the Discovery Service status.

**Syntax:**

```
#show_gateway
```

**Parameters:**

None

**Example:**

```
#show_gateway  
GATEWAY : 192.168.1.11
```

## #show\_gateway

The #show\_gateway command displays the current gateway address of the 4x1 Multiview Seamless Switcher. Use the #set\_gateway command to set the gateway address.

**Syntax:**

```
#show_gateway
```

**Parameters:**

None

**Example:**

```
#show_gateway  
GATEWAY : 192.168.1.11
```

## #show\_hdcp

The #show\_hdcp command displays the current HDCP setting for inputs or outputs.

### Syntax

```
#show_hdcp param1 param2
```

### Parameters

*param1* Value [0 ... 1]

Value	Description
0	Input
1	Output

*param2\** Value [0 ... 1]

Value	Description
0	All
1 - 4	Input

\*If *param1* = 0, then *param2* can be any value from 0 to 4. If *param1* = 1, then *param2* = 1.

### Examples

```
#show_hdcp 0 1
HDCP SET TO ACCEPT ON INPUT 1
```

```
#show_hdcp 1 1
HDCP SET TO FOLLOW INPUT ON OUTPUT 1
```

## #show\_http\_port

The #show\_http\_port command displays the current HTTP listening port of the 4x1 Multiview Seamless Switcher for HDMI. Use the #set\_http\_port command to set the HTTP listening port.

### Syntax

```
#show_http_port
```

### Parameters

*None*

### Examples

```
#show_http_port  
HTTP PORT IS 80
```

## #show\_hue

The #show\_hue command displays the current hue setting for all outputs. If *param1* = 0, then the hue value for all inputs are returned.

### Syntax

```
#show_hue param1
```

### Parameters

<i>param1</i>	Input	[0 ... 4]
---------------	-------	-----------

### Example

```
#show_hue 1  
INPUT 1 IS SET TO HUE VALUE 30
```

## #show\_ip

The #show\_ip command displays the current IP address of the 4x1 Multiview Seamless Switcher for HDMI.

### Syntax

```
#show_ip
```

### Parameters

*None*

### Example

```
#show_ip  
IP ADDRESS : 192.168.1.190
```

## #show\_ipconfig

The #show\_ipconfig command displays the current TCP/IP settings.

### Syntax

```
#show_ipconfig
```

### Parameters

*None*

### Example

```
#show_ipconfig
IP CONFIGURATION IS:
(STATIC)
    IP : 192.168.1.190
NETMASK : 255.255.255.0
GATEWAY : 192.168.1.11
MAC ADDRESS = 00:1c:91:03:b0:00
```

## #show\_ipmode

The #show\_ipmode command displays the current IP mode. To set the IP mode, use the #show\_ipmode command.

### Syntax

```
#show_ipmode
```

### Parameters

*None*

### Example

```
#show_ipmode
IP MODE SET TO STATIC
```

## #show\_ir

The #show\_ir command displays the IR channel of the switcher.

### Syntax

```
#show_ir
```

### Parameters

*None*

### Example

```
#show_ir  
IR CHANNEL IS SET TO 0
```

## #show\_mac\_addr

The #show\_mac\_addr command displays the MAC address of the switcher.

### Syntax

```
#show_mac_addr
```

### Parameters

*None*

### Example

```
#show_mac_addr  
MAC ADDRESS IS 00:1c:91:03:b0:00
```

## #show\_me

The #show\_me command enables or disables the “Show Me” feature. When the “Show Me” feature is enabled, all the buttons and LED indicators on the front panel (except for the Exit button) will flash. This quickly identifies a unit and is useful when multiple units are being used. The default setting is Off.

### Syntax

```
#show_me
```

### Parameters

*None*

### Example

```
#show_me 1  
SHOW ME FUNCTION IS ENABLED
```

## #show\_netmask

The #show\_netmask command displays the current net mask of the HD Video Wall Controller. Use the #set\_netmask command to set the net mask.

### Syntax

```
#show_netmask
```

### Parameters

*None*

### Example

```
#show_netmask  
NETMASK : 255.255.255.0
```

## #show\_osd

The #show\_osd command displays the current OSD state (ON or OFF).

### Syntax

```
#show_osd
```

### Parameters

*None*

### Example

```
#show_osd  
OSD IS SET TO ON
```



## #show\_output

The #show\_output command displays the current output resolution for the display area. Use the #set\_output command to set the output resolution of the display area.

### Syntax

```
#show_output
```

### Parameters

*None*

### Example

```
#show_output  
OUTPUT RESOLUTION IS SET TO 1280x720P 60HZ
```

## #show\_power

The #show\_power command displays the current power state. Use the #power command to power-ON or power-OFF the switcher.

### Syntax

```
#show_power
```

### Parameters

*None*

### Example

```
#show_power  
POWER IS ON
```

## #show\_preset\_name

The #show\_preset\_name command displays the name of the specified preset. To assign a name to a preset, use the #set\_preset\_name command.

### Syntax

```
#show_preset_name param1
```

### Parameters

<i>param1</i>	Preset	[6 ... 20]
---------------	--------	------------

### Example

```
#show_preset_name 8  
THE NAME FOR PRESET 8 IS:MyWinCfg
```

## #show\_saturation

The #show\_saturation command displays the saturation for all outputs. If *param1* = 0, then the saturation value for all inputs are returned. Use the #set\_saturation command to set the output resolution.

### Syntax

```
#show_saturation param1
```

### Parameters

<i>param1</i>	Input	[0 ... 4]
---------------	-------	-----------

### Example

```
#show_saturation 1  
INPUT 1 IS SET TO SATURATION VALUE 65
```

## #show\_tcp\_access

The `#show_tcp_access` command displays the current TCP access state (enabled or disabled). Use the `#use_tcp_access` command to enable or disable TCP access.

### Syntax

```
#show_tcp_access
```

### Parameters

*None*

### Example

```
#show_tcp_access  
TCP ACCESS IS DISABLED
```

## #show\_telnet\_port

The `#show_telnet_port` command displays the current Telnet port. Use the `#set_telnet_port` command to set the Telnet listening port.

### Syntax

```
#show_telnet_port
```

### Parameters

*None*

### Example

```
#show_telnet_port  
TELNET PORT IS 23
```

## #show\_telnet\_user

The #show\_telnet\_user command displays the login name (username) used in the current Telnet session.

### Syntax

```
#show_telnet_user
```

### Parameters

*None*

### Example

```
#show_telnet_user  
TELNET INTERFACE USERNAME IS bo55man
```

## #show\_udp\_port

The #show\_udp\_port command displays the current UDP serial port. Use the #set\_udp\_port command to set the UDP listening port.

### Syntax:

```
#show_udp_port
```

### Parameters:

*None*

### Example:

```
#show_udp_port  
UDP COMMUNICATION PORT IS: 1002
```

## #show\_udp\_remote\_ip

The #show\_udp\_remote\_ip command displays the current remote UDP address. Use the #set\_udp\_remote\_ip command to set the remote UDP address.

### Syntax

```
#show_udp_remote_ip
```

### Parameters

*None*

### Example

```
#show_udp_remote_ip  
UDP REMOTE IP ADDRESS : 192.168.1.227
```

## #show\_udp\_remote\_port

The #show\_udp\_remote\_port command displays the current remote UDP port. Use the #set\_udp\_remote\_port command to set the remote UDP port.

### Syntax

```
#show_udp_remote_port
```

### Parameters

*None*

### Example

```
#show_udp_remote_port  
REMOTE UDP COMMUNICATION PORT IS: 508
```

## #show\_ver\_data

The #show\_ver\_data command displays the current software and hardware version.

### Syntax

```
#show_ver_data
```

### Parameters

*None*

### Example

```
#show_ver_data  
SOFTWARE AND HARDWARE VERSION:V1.40
```

## #unmask

The #unmask command unmask the specified output(s). Use the #mask command to mask the specified window(s). Multiple windows may be specified. If *param1* = 0, then all windows are unmasked.

### Syntax

```
#unmask param1 [param2...param4]
```

### Parameters

<i>param1</i>	Window	[0 ... 4]
---------------	--------	-----------

### Example

```
#unmask 2  
WINDOW 2 IS UNMASKED
```

## #use\_discovery

The #use\_discovery command enables or disables the Discovery Service which is used by the Gefen Syner-G Discovery Tool. The default value is Enabled.

### Syntax

```
#use_discovery param1
```

### Parameters

*param1* Value [0 ... 1]

Value	Description
0	Disabled
1	Enabled

### Example

```
#use_discovery 1  
DISCOVERY PROTOCOL IS ENABLED
```

## #use\_tcp\_access

The #use\_tcp\_access command enables or disables Telnet access.

### Syntax

```
#use_tcp_access param1
```

### Parameters

*param1*

Value

[0 ... 1]

Value	Description
0	Disable Telnet access
1	Enable Telnet access

### Example

```
#use_tcp_access 1  
TCP ACCESS IS ENABLED
```



## #use\_telnet\_pass

The `#use_telnet_pass` command forces the password credentials for each Telnet session. The default setting is disabled. Use the `#set_telnet_pass` command to set the Telnet password.

### Syntax

```
#use_telnet_pass param1
```

### Parameters

*param1* Value [0 ... 1]

Value	Description
0	Disable password
1	Enable password

### Example

```
#use_telnet_pass 1
TELNET INTERFACE PASSWORD IS ENABLED
```

## #use\_udp\_access

The #use\_udp\_access command enables or disables UDP access.

### Syntax

```
#use_udp_access param1
```

### Parameters

*param1* Value [0 ... 1]

Value	Description
0	Disable UDP access
1	Enable UDP access

### Example

```
#use_udp_access 1
UDP ACCESS IS ENABLED
```

**m**

The `m` command displays the current routing status of the 4x1 Multiview Seamless Switcher for HDMI. Masking and locking status of the switcher is also provided. Do not precede the `m` command with the “#” symbol.

**Syntax**

```
m
```

**Parameters**

*None*

**Example**

```
m  
WINDOW : A B C D  
IN      : 1 2 3 4
```

**r**

The `r` command routes the specified input to the output. Do not precede this command with the “#” symbol. Also see the `s` command. If `param2 = 0`, then the specified input (`param1`) will be routed to all window outputs.

**Syntax**

```
r param1 param2
```

**Parameters**

<i>param1</i>	Input	[1 ... 4]
<i>param2</i>	Output	[0, A ... D]

**Examples**

```
r 3 a  
SOURCE 3 IS SET TO WINDOW OUTPUT FULL
```

```
r 1 0  
SOURCE 1 IS SET TO WINDOW OUTPUTS FULL
```

**S**

The `s` command routes the specified input to all outputs. Do not precede this command with the “#” symbol.

**Syntax**

```
s param1
```

**Parameters**

<i>param1</i>	Input	[1 ... 4]
---------------	-------	-----------

**Example**

```
s 2  
ALL OUTPUTS ARE ROUTED TO INPUT 2
```

# Web Interface

## Using the built-in Web Interface

Access the built-in Web interface by entering the IP address of the 4x1 Multiview Seamless Switcher for HDMI that was specified in step 3 under [IP / UDP Configuration](#). Once connected to the switcher, the login screen will be displayed.

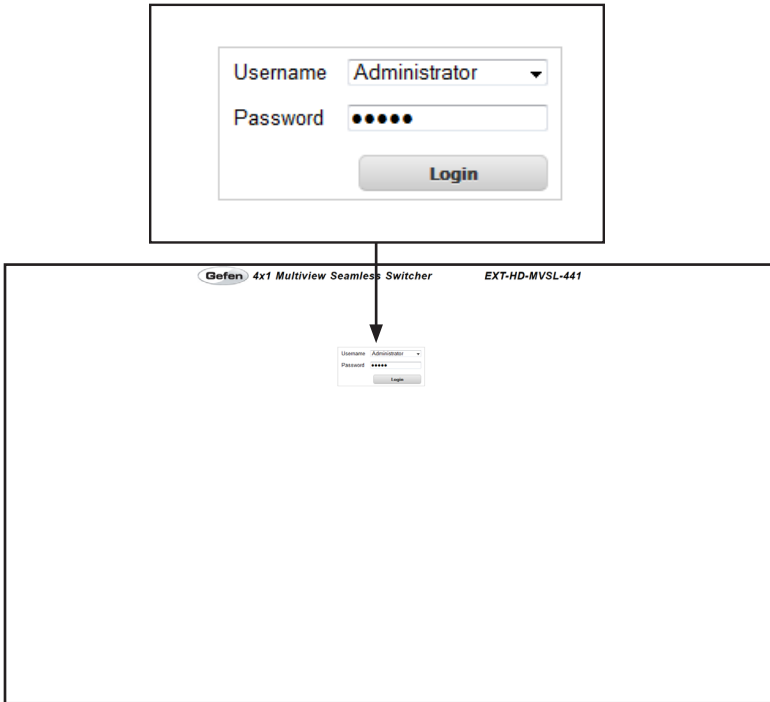

### Username

Select the username from the drop-down list.

#### Options:

Operator, Administrator

Administrator login provides unrestricted access to all features and settings. Operator login limits access to routing, display information, and routing preset features.

### Password

Enter the password for the associated username. The password can also be set using the `#set_webui_op_pass` and the `#set_webui_ad_pass` commands. The password is masked when it is entered.

The Web interface is divided into seven pages: **Routing**, **I/O Setup**, **Window Setup**, **Presets**, **EDID**, **Network**, and **System**. Each main page is represented by a tab at the top of the screen. The **EDID** page has its own set of sub-tabs. Click on the desired tab to open the desired page.



**NOTE:** In order to view all seven tabs at the top of the screen, the user must be logged in as “Administrator”. If logged-in as “Operator”, only the **Routing** tab will be visible.

## Main ► Routing

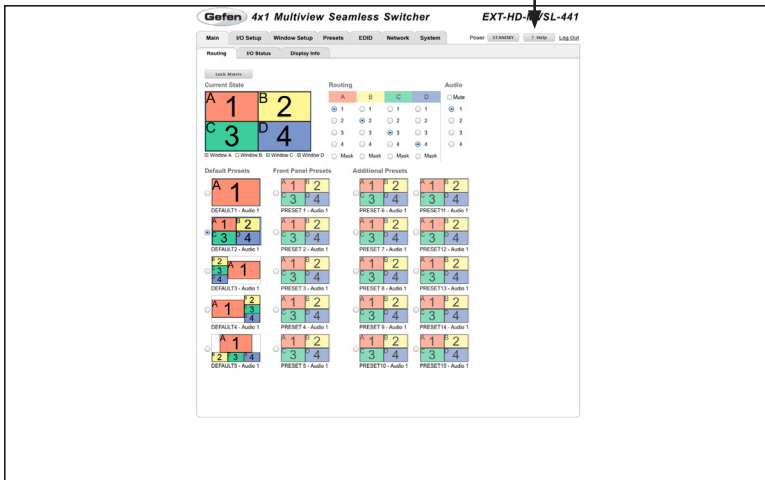

### Power

Click this button to toggle the power state of the 4x1 Multiview Seamless Switcher for HDMI. When the switcher is powered-on, the button will read “STANDBY”.

### ? Help

Click the “? Help” button to display context-sensitive help. This button is available on all pages.

### Log Out

Click **Log Out** to terminate the current Web session and return to the login page.

## Lock Matrix

Locks or unlocks the matrix. Once the switcher is locked, settings cannot be changed using the front-panel buttons or through the Web GUI.

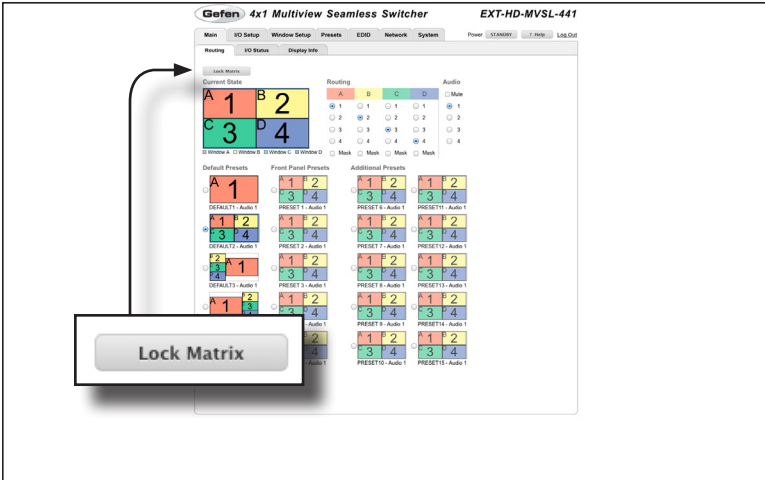

When the matrix is locked, the button text will read “Unlock Matrix” and a red bar will appear across the top portion of the screen with the text “Matrix is LOCKED”.

**Matrix is LOCKED.**

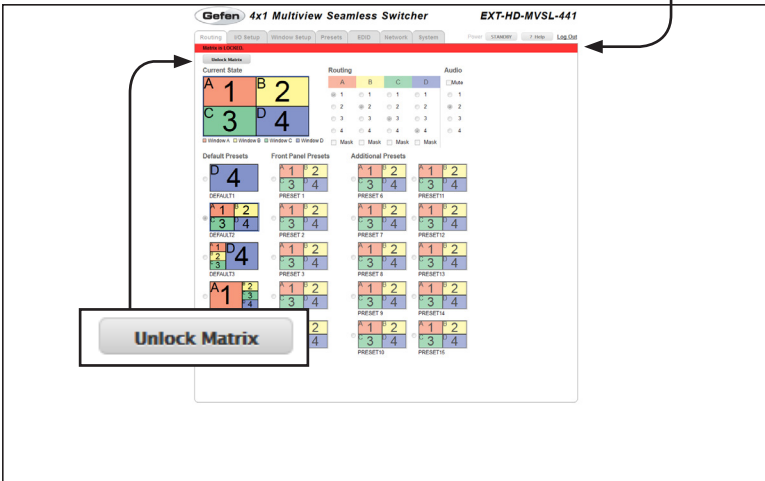

Click the “Unlock Matrix” button to unlock the matrix.



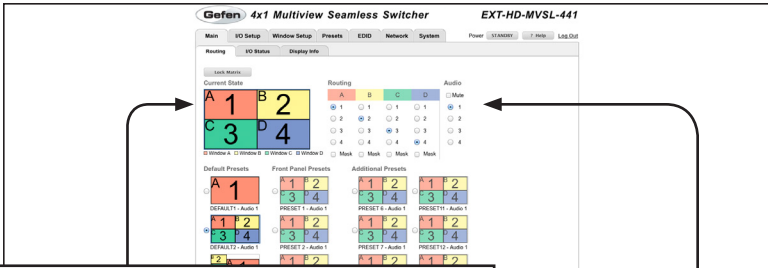

**Current State**

A 1	B 2
C 3	D 4

Window A  
  Window B  
  Window C  
  Window D

**Current State**

Displays the current preset that is loaded into memory.

Each window is color-coded for easy identification. The letter in the upper-left corner of each window represents the output.

The input used by each window output is displayed using a number from 1 to 4.

**Routing**

Click the radio button to select the desired input. Each column represents an output.

Routing				Audio
A	B	C	D	<input type="checkbox"/> Mute
<input checked="" type="radio"/> 1	<input type="radio"/> 1	<input type="radio"/> 1	<input type="radio"/> 1	<input checked="" type="radio"/> 1
<input type="radio"/> 2	<input checked="" type="radio"/> 2	<input type="radio"/> 2	<input type="radio"/> 2	<input type="radio"/> 2
<input type="radio"/> 3	<input type="radio"/> 3	<input checked="" type="radio"/> 3	<input type="radio"/> 3	<input type="radio"/> 3
<input type="radio"/> 4	<input type="radio"/> 4	<input type="radio"/> 4	<input checked="" type="radio"/> 4	<input type="radio"/> 4
<input type="checkbox"/> Mask	<input type="checkbox"/> Mask	<input type="checkbox"/> Mask	<input type="checkbox"/> Mask	

**Mask**

Click to place a check mark in the check box in order to mask the selected output. Click to clear the check box and remove the mask.

**Audio**

Click the radio button to select the input to be used as the audio source.

**Mute**

Click to place a check mark in this check box in order to mute the selected input. Click to clear the check box and un-mute the input.

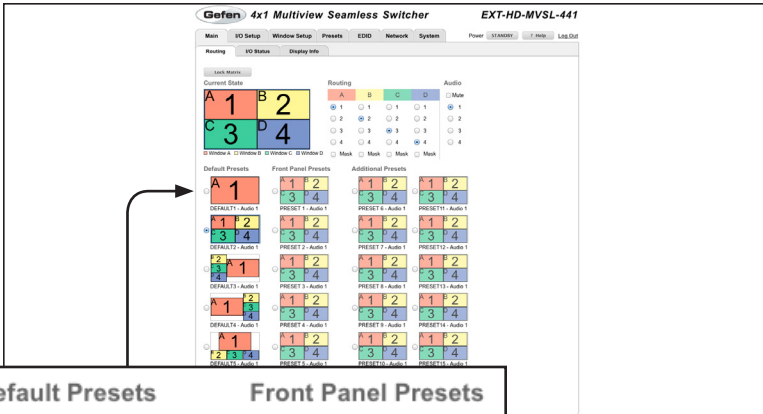

**Default Presets**



DEFAULT1 - Audio 1



DEFAULT2 - Audio 1

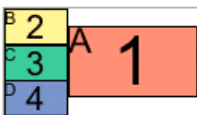

DEFAULT3 - Audio 1

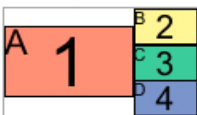

DEFAULT4 - Audio 1



DEFAULT5 - Audio 1

**Front Panel Presets**



PRESET 1 - Audio 1



PRESET 2 - Audio 1



PRESET 3 - Audio 1



PRESET 4 - Audio 1



PRESET 5 - Audio 1

**Default Presets**

Click the radio button to select the desired preset. The default presets are identical to the Default preset buttons on the front panel of the matrix. If Default 1 preset is selected, then additional image adjustment information will be displayed. See the next page for details on each of these features.

**Front Panel Presets**

Click the radio button to select the desired preset. These presets are identical to the Custom buttons on the front panel of the matrix.

### Routing (Default 1 only)

When the Default 1 preset is loaded, routing buttons will appear over each column of inputs. Click these buttons (A - D) to change the output that is displayed. Each output will use the currently selected input (1 - 4).

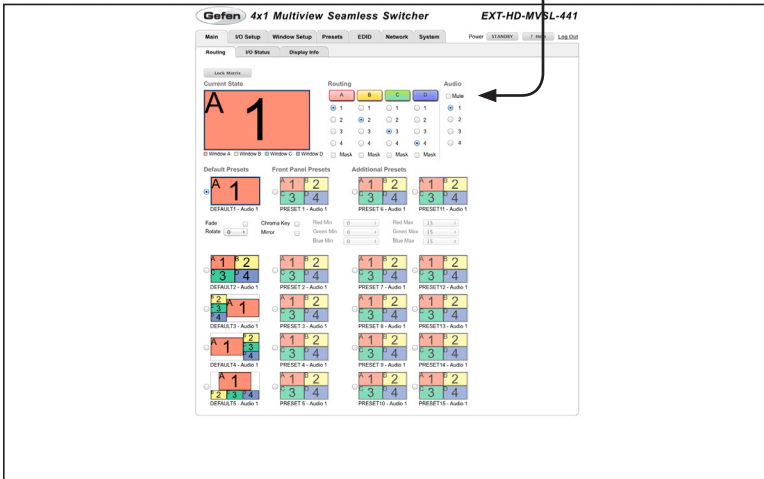
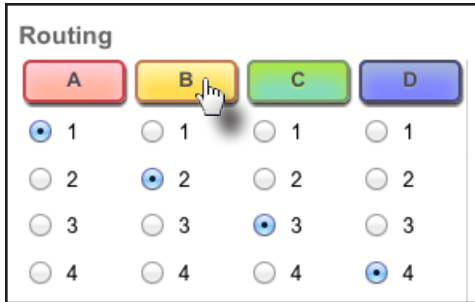

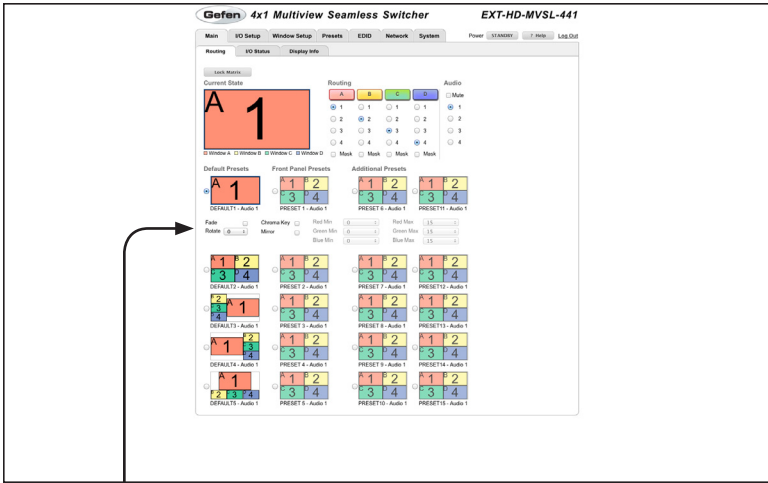

**Fade**

This feature adds a 1 second transition between window output A and another window output. Click to place a check mark in the check box to enable the fade effect. Click to clear the check box and disable the fade effect. This feature is only available when using a single window. See [Using Fade](#) for more information using this effect.

**Rotate**

Click the drop-down list to select the desired rotation of the output image. The output image can be rotated 90° clockwise, 90° counter-clockwise, or flipped 180°, horizontally. This feature is only available when using a single window.

**Chroma Key**

Click to place a check mark in the check box in order to enable chroma keying for window output A. Click to clear the check box and disable the chroma keying. This feature is only available when using a single window. See [Using Chroma Key](#) for more information.

**Mirror**

Applies a horizontal transformation (rotated 180° about the y-axis) to window output A. This feature is only available when using a single window. See [Using Mirror](#) for more information on using this effect.

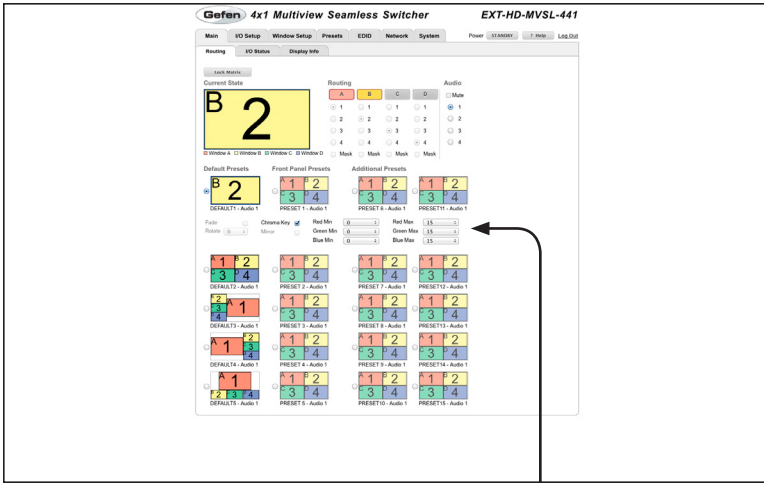

Red Min	<input type="text" value="0"/>	Red Max	<input type="text" value="15"/>
Green Min	<input type="text" value="0"/>	Green Max	<input type="text" value="15"/>
Blue Min	<input type="text" value="0"/>	Blue Max	<input type="text" value="15"/>

**Min (Red, Green, Blue)**

Click the drop-down list to select the desired minimum RGB colors for the chroma key value. See [Using Chroma Key](#) for more information.

**Max (Red, Green, Blue)**

Click the drop-down list to select the desired maximum RGB colors for the chroma key value. See [Using Chroma Key](#) for more information.

The Chroma Key check box must be enabled in order to access each of these drop-down lists.

Options (min. / max. values)	
0	128
16	144
32	160
48	176
64	192
80	208
96	224
112	240

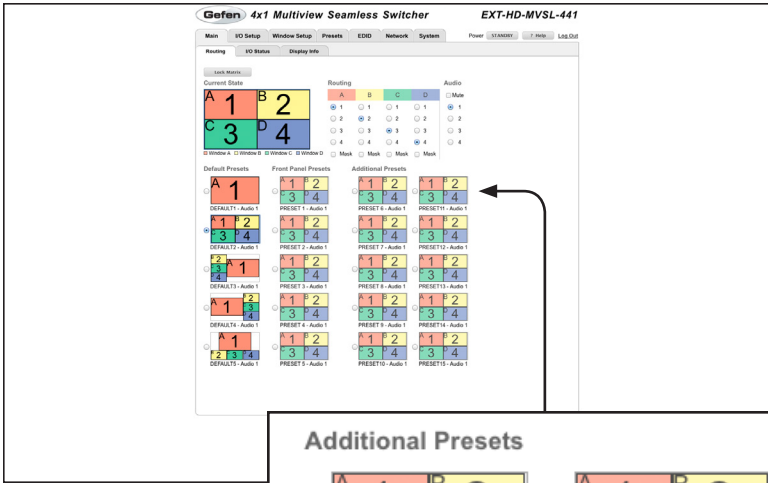

**Additional Presets**

The Web interface provides an additional 10 presets which are not available from the front panel buttons. Click the radio button to select the desired preset.

By default, each of these presets use the same window arrangement as Default Preset 2.

**Additional Presets**

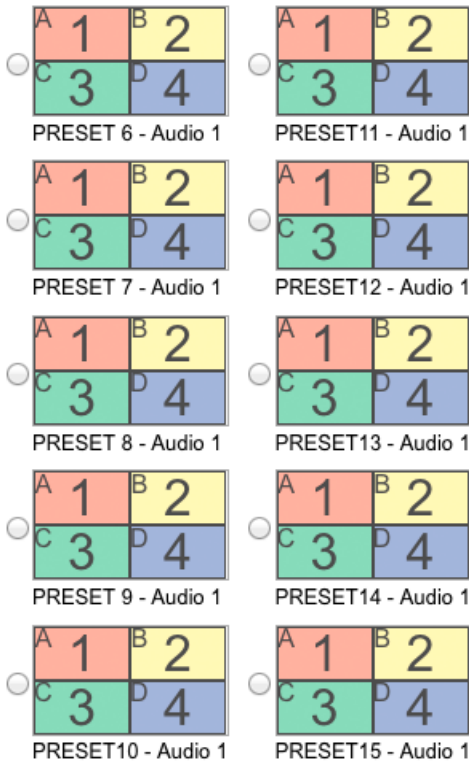

## Main ► I/O Status

**Output**

Name	OUTPUT1
RSENSE	On
HPD	High
HDCP	Inactive

es Switcher    EXT-HD-MVSL-441

Menu   I/O Setup   Window Setup   Presets   EDIO   Network   System   Power (1.5500V)   0.7.0000   Log Out

Heading   I/O Status   Display Info

Output

Name	OUTPUT1			
RSENSE	On			
HPD	High			
HDCP	Inactive			

Input

Name	INPUT1	INPUT2	INPUT3	INPUT4
Color Depth	8-bit	8-bit	8-bit	8-bit
Color Space	RGB	-	-	-
HDCP	No	No	No	No
Active Signal	Yes	No	No	No
Vertical Resolution	720	0	0	0
Horizontal Resolution	1280	0	0	0
Progressive / Interlaced	P	-	-	-
Refresh Rate	60Hz	60	60	60
Video Mode	HDMI	-	-	-

**Output**

Displays the Name, RSENSE, HPD, and HDCP status for the output.

**Name**

Displays the name of the output.

**RSENSE**

Displays the current Rsense state.

**HPD**

Displays the current HPD state.

**HDCP**

Displays the current HDCP state. The HDCP state can be set using the `#set_hdcp` command or through the **I/O Setup ► HDCP** section of the Web interface.

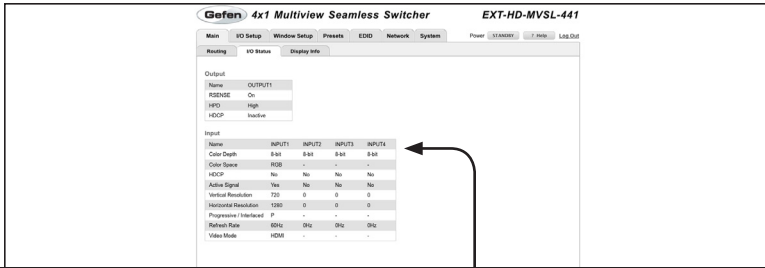

## Input

Name	INPUT1	INPUT2	INPUT3	INPUT4
Color Depth	8-bit	8-bit	8-bit	8-bit
Color Space	RGB	-	-	-
HDCP	No	No	No	No
Active Signal	Yes	No	No	No
Vertical Resolution	720	0	0	0
Horizontal Resolution	1280	0	0	0
Progressive / Interlaced	P	-	-	-
Refresh Rate	60Hz	0Hz	0Hz	0Hz
Video Mode	HDMI	-	-	-

### Name

The name of the input.

### Color Depth

The color depth of the input signal (8-bit, 16-bit, etc).

### Color Space

The color space (RGB or YUV) of the input signal.

### HDCP

Displays whether or not HDCP is detected on the input.

### Active Signal

Detects whether an input signal is present or not.

### Vertical Resolution

The vertical resolution (in pixels) of the input signal.

### Horizontal Resolution

The horizontal resolution (in pixels) of the input signal.

### Progressive / Interlaced

Detects whether the input signal is progressive or interlaced.

### Refresh Rate

The refresh rate (frequency) of the input signal.

### Video Mode

The video mode (HDMI or DVI) of the input signal.



## Main ► Display Info

The screenshot shows the web interface for the Gefen 4x1 Multiview Seamless Switcher (EXT-HD-MVSL-441). The 'Display Info' page is active, showing a 'Choose EDID' dropdown menu set to 'Bank 1'. Below this, the 'Feature' section lists various display capabilities, and the 'Audio Formats' section lists supported audio formats.

Feature	
24Hz Frame Rate	TRUE
Max Resolution	1920x1080 60Hz
Max Color Depth	8 Bits
Mode (DVI/HDMI)	HDMI
Max Audio Channels	2-Ch
Monitor Name	HD-MVSL-441

Audio Formats	
LPCM	YES
DTS-HD	NO
DTS Digital Surround	NO
Dolby Digital (AC3)	NO
Dolby TrueHD	NO

**Choose EDID**

Select the EDID from the drop-down list. The selected EDID will be copied from the Output or selected EDID Bank to the desired input(s) and used by the source.

Options
Bank 1 ... Bank 8
Output 1

**Feature / Audio Formats**

Displays the capabilities of the display (or sink device), based on the EDID.

## I/O Setup ► Settings

**Select Input**

Select the desired input from the drop-down list. The Brightness, Contrast, Saturation, and Hue settings are applied to the selected input.

Options
input 1
input 2
input 3
input 4

**Brightness**

Enter the desired brightness value in this field.

**Contrast**

Enter the desired contrast value in this field.

**Saturation**

Enter the desired saturation value in this field.

**Hue**

Enter the desired hue value in this field.

**Reset All**

Click this button to reset picture setting to factory-default.

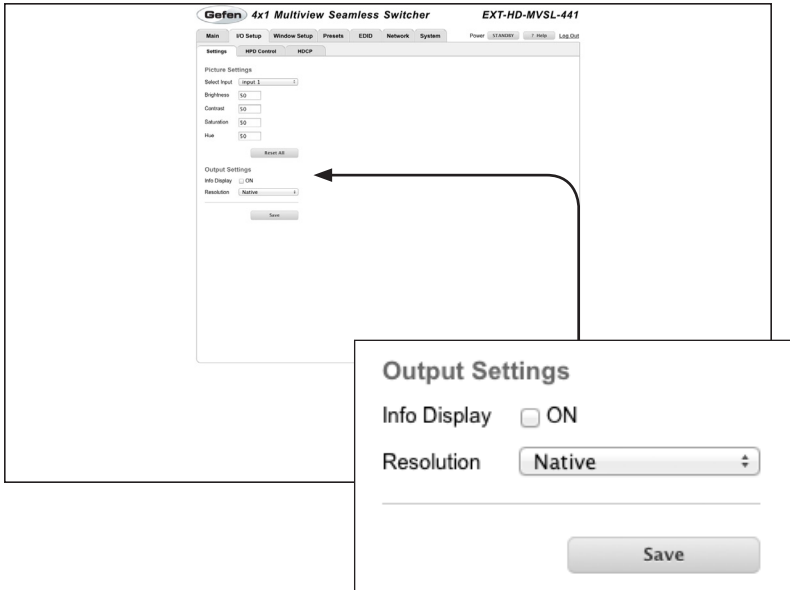

### Info Display

When enabled, this feature will momentarily display information about the current window, whenever a change is made to the input / output resolution, source routing, or preset. To enable this feature, click the check box.

### Resolution

Select the desired output resolution from the drop-down list.

Options	
480p	1280 x 1024
576p	1366 x 768
720p @ 50 Hz	1440 x 900
720p @ 60 Hz	1600 x 900
1080p @ 24 Hz	1600 x 1200
1080p @ 50 Hz	1680 x 1050
1080p @ 60 Hz	1920 x 1200
1024 x 768	Native
1280 x 800	

### Save

Click to save the current settings.

## I/O Setup ► HPD Control

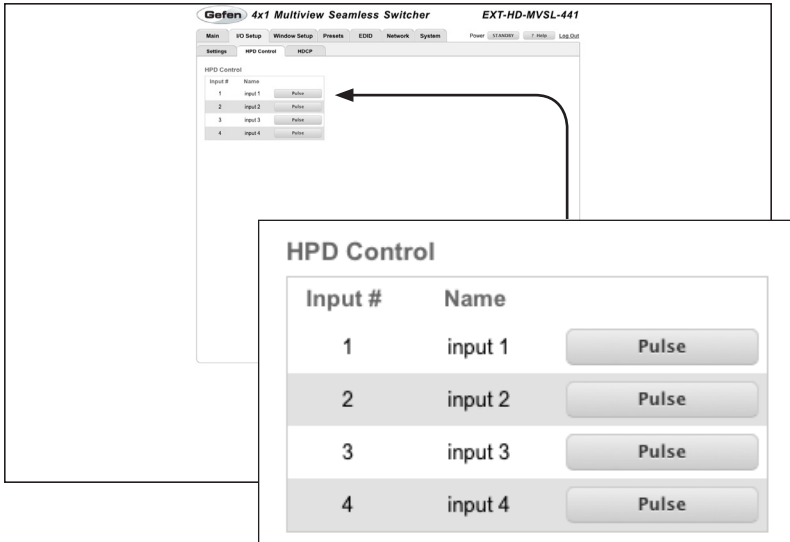
**Input #**

The number of the input.

**Name**

The name of the input.

**Pulse**

Click the Pulse button to cycle the HDP line on the desired input. This is the equivalent of physically disconnecting and reconnecting the HDMI cable between the source device and the switcher.

## I/O Setup ► HDCP

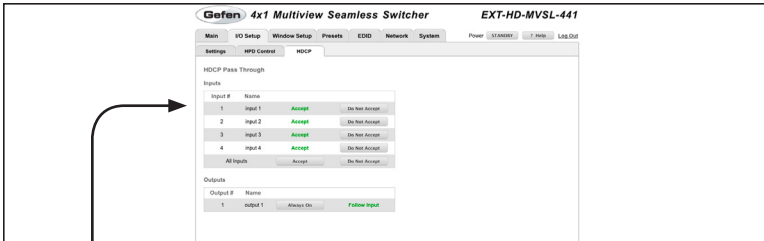

## HDCP Pass Through

## Inputs

Input #	Name		
1	input 1	Accept	Do Not Accept
2	input 2	Accept	Do Not Accept
3	input 3	Accept	Do Not Accept
4	input 4	Accept	Do Not Accept
All Inputs		Accept	Do Not Accept

**Input #**

The number of the input.

**Name**

The name of the input.

**Accept / Not Accept**

Click the Accept button to allow HDCP content to pass on the input. Click the Do Not Accept button to prevent HDCP content from being transmitted to the input.

To change all inputs to “Accept” at once, click the Accept button in the row labeled “All Inputs”.

To change all outputs to “Do Not Accept” at once, click the Do Not Accept button in the row labeled “All Inputs”.



## Outputs

Output #	Name	Always On	Follow Input
1	output 1	Always On	Follow Input

### Always On / Follow Input

Click the Always On button to allow HDCP to pass through on the output. Click the Follow Input button to have the output follow the input setting (Accept / Not Accept). See the previous page for details.

To change all outputs to "Always On" at once, click the Always On button in the row labeled "All Outputs".

## Window Setup

The screenshot shows the 'Window Setup' configuration page for a Gefen 4x1 Multiview Seamless Switcher. The 'Select Preset' dropdown is set to 'LIVE'. The main display area shows a 2x2 grid of windows: Window A (red, labeled '1'), Window B (yellow, labeled '2'), Window C (green, labeled '3'), and Window D (blue, labeled '4'). Below the grid, there is a 'Lock Aspect Ratio' checkbox (unchecked) and a legend for the window colors: Window A (red), Window B (yellow), Window C (green), and Window D (blue). Red circles are drawn around the corners of the main window grid to indicate where users can click and drag to re-size the windows.

### Select Preset

Click this drop-down list to select and load the desired preset.

### Lock Aspect Ratio

Click to place a check mark in the check box in order to lock the aspect ratio. When enabled, the height and width of a window will be proportional when resized. Click to clear the check box and allow the window to be re-sized, without restriction.

### Interactive Workspace

Position the mouse over any window in this area to display the “move” icon. Click and drag to reposition a window. The selected window will be displayed in the Select Window drop-down list (see the next page). Windows can also be re-sized to the desired height and width by clicking and dragging any of the four corners (circled in red) of a window.

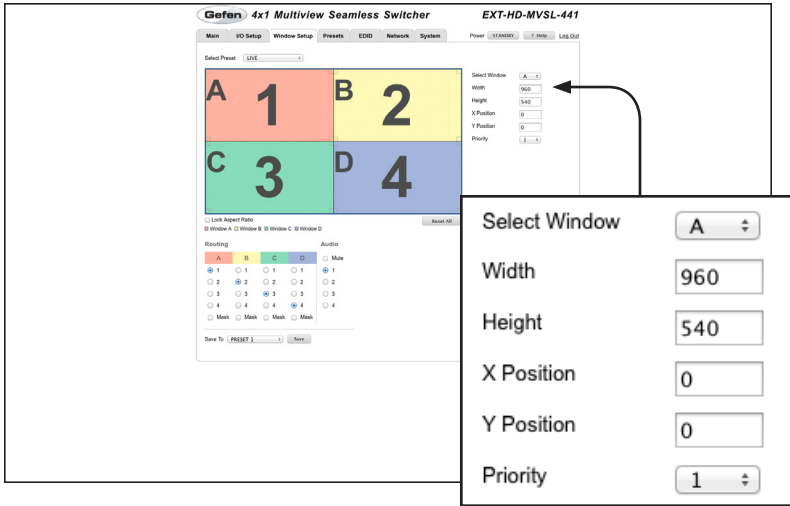

### Select Window

Click this drop-down list to select the desired window. A window can also be selected by clicking the desired window in the Interactive Workspace (see the previous page).

### Width

The width (in pixels) of the selected window. If this value is changed, the associated window in the interactive workspace will automatically be updated. Alternatively, if the window is resized using the mouse, this value is automatically updated.

### Height

The height (in pixels) of the selected window. If this value is changed, the associated window in the interactive workspace will automatically be updated. Alternatively, if the window is resized using the mouse, this value is automatically updated.

### X Position

The horizontal position (in pixels), relative to the current output resolution, of the selected window. If this value is changed, the associated window in the interactive workspace will automatically be updated. Alternatively, if the window is repositioned using the mouse, this value is automatically updated.

### Y Position

The vertical position (in pixels), relative to the current output resolution, of the selected window. If this value is changed, the associated window in the interactive workspace will automatically be updated. Alternatively, if the window is repositioned using the mouse, this value is automatically updated.

### Priority

Click this drop-down list to change the priority of the selected window. See [Window Priority](#) for more information on this feature.



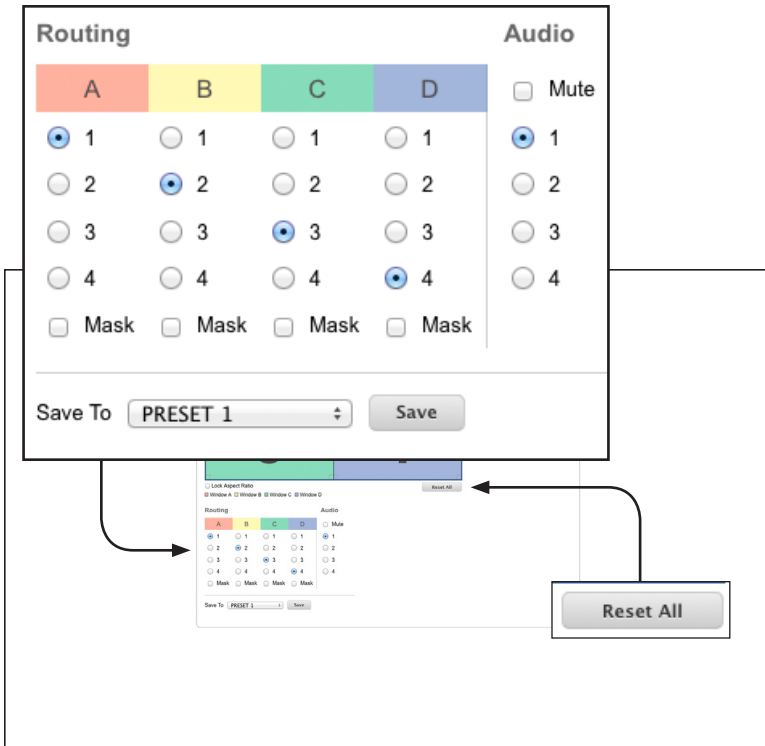

### Routing

Click the radio button to select the desired input. Each column represents an output.

### Mask

Click to place a check mark in the check box in order to mask the selected output. Click to clear the check box and remove the mask.

### Audio

Click the radio button to select the input to be used as the audio source. The `#set_audio` command can also be used to assign the audio source.

### Mute

Click to place a check mark in this check box in order to mute the selected input. Click to clear the check box and unmute the input.

### Save









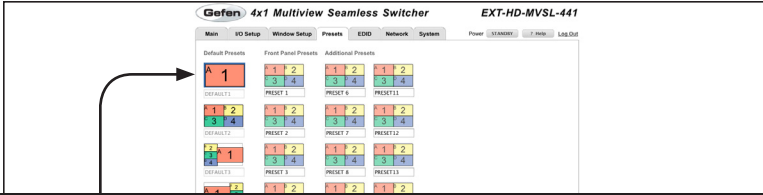





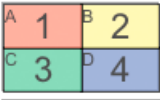



Click to save the current settings. The current settings will be saved to the selected preset displayed in the Select Preset drop-down list.

### Reset All

Click this button to reset the window layout to four equally-sized windows.

## Presets



Default Presets	Front Panel Presets	Additional Presets	
 <p>DEFAULT1</p>	 <p>PRESET 1</p>	 <p>PRESET 6</p>	 <p>PRESET 11</p>
 <p>DEFAULT2</p>	 <p>PRESET 2</p>	 <p>PRESET 7</p>	 <p>PRESET 12</p>
 <p>DEFAULT3</p>	 <p>PRESET 3</p>	 <p>PRESET 8</p>	 <p>PRESET 13</p>
 <p>DEFAULT4</p>	 <p>PRESET 4</p>	 <p>PRESET 9</p>	 <p>PRESET 14</p>
 <p>DEFAULT5</p>	 <p>PRESET 5</p>	 <p>PRESET 10</p>	 <p>PRESET 15</p>
<input type="button" value="Save"/>			

### Preset Names

Type the desired name of each preset in these fields.

### Save

Click to save the changes to the preset names.



## Import Presets

**Browse...**

**Upload**

## Export Presets

**Download**

### **Browse...**

Click this button to select the desired preset file.

### **Upload**

Click this button to upload the preset file to the switcher.

### **Download**

Click to save the current preset configurations and names to file.

## EDID ► Assign

Lock EDID

### Lock EDID

Secures the Local EDID and disables automatic EDID loading during power-up.

If the **Lock EDID** button is clicked (enabled), the “EDID locked on power cycle” message will be displayed in red. The local EDID information will now be locked once the switcher is rebooted. Click the **Unlock EDID** button to disable the Lock EDID feature.

Unlock EDID

EDID locked on power cycle.

Copy EDID From

Bank1

Copy EDID To - Please select from the inputs below

### Copy EDID From

Select the EDID from the drop-down list. The EDID will be copied from the Output or selected EDID bank to the destination

#### Options

Bank1 ... Bank8

A - Output 1

**Inputs**

Copy To	EDID Modes
<input type="checkbox"/>	Internal - 1080p 2 ch au
<input type="checkbox"/>	Internal - 1080p 2 ch au
<input type="checkbox"/>	Internal - 1080p 2 ch au
<input type="checkbox"/>	Internal - 1080p 2 ch au
<input type="checkbox"/>	Select All Inputs

**Copy To**  
Place a check mark in the desired check box to select or deselect the desired input(s).

HD-MVSL-441

Copy EDID To: Please select from the inputs below

Copy To	EDID Modes	Input #	Name	EDID Source	EDID Name
<input type="checkbox"/>	Internal - 1080p 2 ch au	1	Input 1	INT 3	HD-MVSL-441
<input type="checkbox"/>	Internal - 1080p 2 ch au	2	Input 2	INT 3	HD-MVSL-441
<input type="checkbox"/>	Internal - 1080p 2 ch au	3	Input 3	INT 3	HD-MVSL-441
<input type="checkbox"/>	Internal - 1080p 2 ch au	4	Input 4	INT 3	HD-MVSL-441

Select All Inputs

Copy To	Bank #	Name	EDID Name
<input type="checkbox"/>	1	Bank1	HD-MVSL-441
<input type="checkbox"/>	2	Bank2	HD-MVSL-441
<input type="checkbox"/>	3	Bank3	HD-MVSL-441
<input type="checkbox"/>	4	Bank4	HD-MVSL-441
<input type="checkbox"/>	5	Bank5	HD-MVSL-441
<input type="checkbox"/>	6	Bank6	HD-MVSL-441
<input type="checkbox"/>	7	Bank7	HD-MVSL-441
<input type="checkbox"/>	8	Bank8	HD-MVSL-441

Select All Banks

Copy    Cancel

**EDID Modes**

Select the EDID mode from the drop-down list.

Options
Internal - 720p 2 ch audio
Internal - 720p Multi ch
Internal - 1080p 2 ch audio
Internal - 1080p Multi ch
External - Output
Custom - User

**Select All Inputs**

Click to place a check mark in the check box to select all inputs. Click to clear the check box and allow the deselect all inputs.

Input #	Name	EDID Source	EDID Name
1	Input 1	INT 3	HD-MVSL-441
2	Input 2	INT 3	HD-MVSL-441
3	Input 3	INT 3	HD-MVSL-441
4	Input 4	INT 3	HD-MVSL-441

Copy EDID To: Please select from the inputs below

Copy To	EDID Source	Input #	Name	EDID Source	EDID Name
<input type="checkbox"/>	Internal ... 1580p 2 (h.aa...)	1	Input 1	INT 3	HD-MVSL-441
<input type="checkbox"/>	Internal ... 1580p 2 (h.aa...)	2	Input 2	INT 3	HD-MVSL-441
<input type="checkbox"/>	Internal ... 1580p 2 (h.aa...)	3	Input 3	INT 3	HD-MVSL-441
<input type="checkbox"/>	Internal ... 1580p 2 (h.aa...)	4	Input 4	INT 3	HD-MVSL-441

Select All Inputs

Copy To	Bank #	Name	EDID Name
<input type="checkbox"/>	1	Bank1	HD-MVSL-441
<input type="checkbox"/>	2	Bank2	HD-MVSL-441
<input type="checkbox"/>	3	Bank3	HD-MVSL-441
<input type="checkbox"/>	4	Bank4	HD-MVSL-441
<input type="checkbox"/>	5	Bank5	HD-MVSL-441
<input type="checkbox"/>	6	Bank6	HD-MVSL-441
<input type="checkbox"/>	7	Bank7	HD-MVSL-441
<input type="checkbox"/>	8	Bank8	HD-MVSL-441

Select All Banks

**Input #**

The number of the input.

**Name**

The name of the input.

**EDID Source**

The current EDID source being used.

**EDID Name**

The name of the EDID.

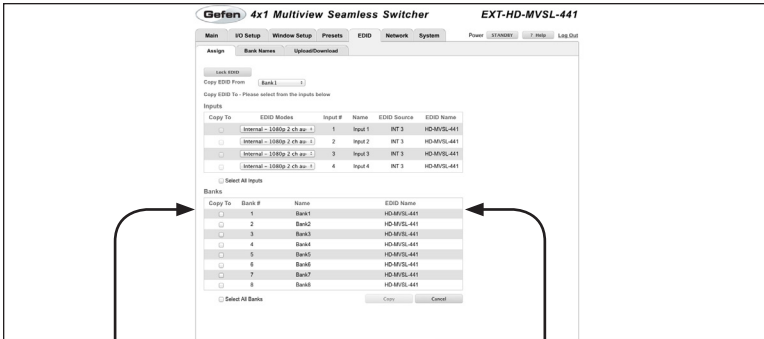

Copy To	Bank #	Name	EDID Name
<input type="checkbox"/>	1	Bank1	HD-MVSL-441
<input type="checkbox"/>	2	Bank2	HD-MVSL-441
<input type="checkbox"/>	3	Bank3	HD-MVSL-441
<input type="checkbox"/>	4	Bank4	HD-MVSL-441
<input type="checkbox"/>	5	Bank5	HD-MVSL-441
<input type="checkbox"/>	6	Bank6	HD-MVSL-441
<input type="checkbox"/>	7	Bank7	HD-MVSL-441
<input type="checkbox"/>	8	Bank8	HD-MVSL-441

Select All Banks

Copy Cancel

**Copy To**

Click to place a check mark in the check box where the EDID will be copied. Click to clear the check box and deselect the bank.

**Bank #**

The number of the bank.

**Name**

The name of the bank.

**Select All Banks**

Click to place a check mark in the check box in order to select all banks. Click to clear the check box and deselect all banks.

**Copy**

Press this button to execute the copy operation.

**Cancel**

Clears all check marks from each box.

## EDID ► Bank Names

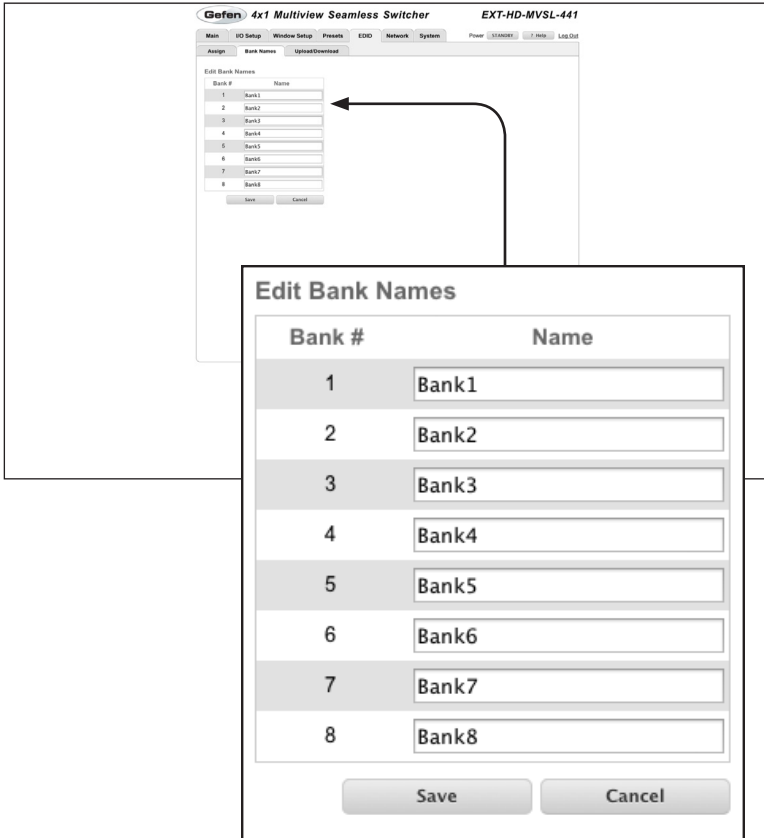
**Bank #**

Indicates the EDID bank number.

**Name**

Type the desired name of the EDID bank in this field.

**Save**

Saves the current name change to the EDID bank(s).

**Cancel**

Restores the previous name or each bank, if the name was edited.

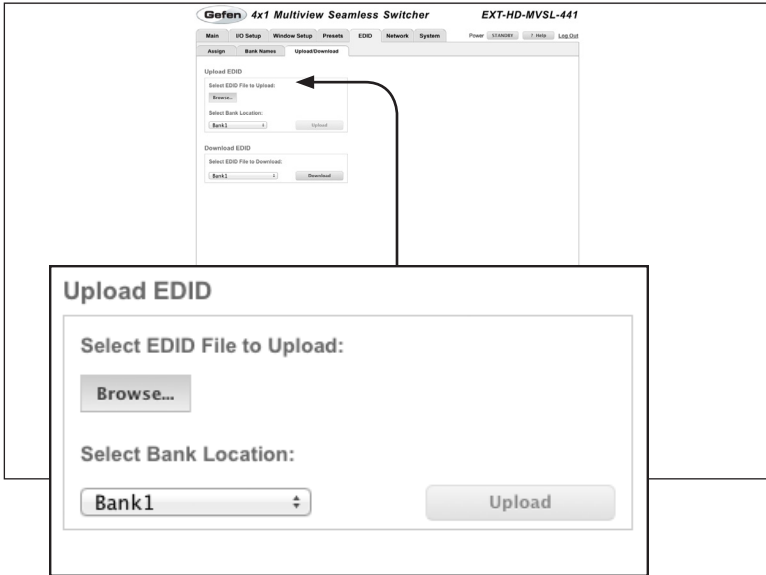

## EDID ► Upload / Download

**Browse...**

Click this button to select the EDID file to be uploaded.

**Select Bank Location**

Click this drop-down list to select the bank to where the EDID will be uploaded.

**Upload**

Click this button to upload the EDID to the specified bank.

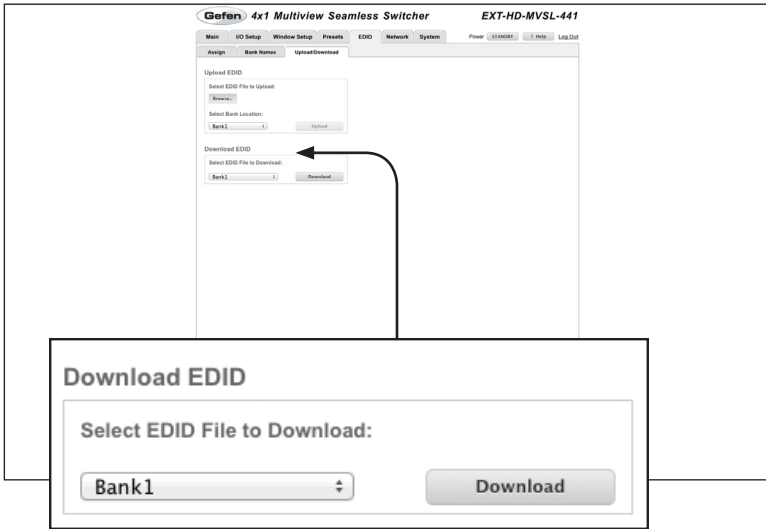

### Select EDID File to Download

Click this box to select the EDID that is to be saved to a file. The EDID file will be saved in binary (.bin) format.

Options
Bank1 ... Bank8
A - [Display Name] (Output)
1 - HD-MVSL-441 ... 4 - HD-MVSL-441 (Inputs)

### Download

Click this button to download the selected EDID to a (.bin) file.

## Network

The screenshot shows the web interface for a Gefan 4x1 Multiview Seamless Switcher (model EXT-HD-MVSL-441). The 'Network' tab is selected. The 'IP Settings' section is highlighted with a callout box. The settings are as follows:

IP Settings	
MAC Address	00:1c:91:03:a0:10
Mode	DHCP
IP Address	10.5.64.199
Subnet	255.255.255.0
Gateway	10.5.64.1
HTTP Port	80

### MAC Address

The MAC address of the switcher. The MAC address cannot be changed.

### Mode

The network mode setting.

Options
Static
DHCP

### IP Address

Enter the IP address of the switcher in this field. This option is only available if the network mode is set to *static*.

### Subnet

Enter the subnet mask of the switcher in this field. This option is only available if the network mode is set to *static*.

### Gateway

Enter the gateway (router) address in this field. This option is only available if the network mode is set to *static*.

### HTTP

Enter the HTTP listening port in this field.

The screenshot shows the web interface for a Gefen 4x1 Multiview Seamless Switcher (EXT-HD-MVSL-441). The 'TCP/Telnet Settings' section is highlighted with a callout box. The settings are as follows:

Setting	Value
Enable TCP Access	<input checked="" type="checkbox"/>
Require Password on Connect	<input checked="" type="checkbox"/>
Show Login Message on Connect	<input checked="" type="checkbox"/>
User Name	<input type="text"/>
Old Password	<input type="text"/>
New Password	<input type="text"/>
Confirm New Password	<input type="text"/>
Terminal Port	23

### Enable UDP Access

Click to place a check mark in the check box to enable TCP. Click to clear the check box and disable TCP access.

### Require Password on Connect

Click to place a check mark in the check box to force the password prompt at the beginning of a Telnet session. Click to clear the check box and disable the password prompt.

### Show Login Message on Connect

Click to place a check mark in the check box to display the Telnet Welcome Message. Click again to clear the check box and disable the Telnet Welcome Message.

### User Name

Enter the user name, required for login, in this field.

### Old Password

Type the current (old) password in this field.

### New Password

Type the new password in this field.

### Confirm Password

Type the new password in this field.

### Terminal Port

Enter the Telnet listening port in this field.

**Gefen 4x1 Multiview Seamless Switcher EXT-HD-MVSL-441**

Menu: **IP Setup** | Window Setup | Presets | EDID | Network | System | Power (12.000V) | 07.2008 | Log Out

**IP Settings**  
 Web Address: 00:1c:9f:03:aa:10  
 Mode: DHCP  
 IP Address: 10.5.64.199  
 Subnet: 255.255.255.0  
 Gateway: 10.5.64.1  
 HTTP Port: 80

**TCP/Telnet Settings**  
 Enable TCP Access:   
 Enable Password on Connect:   
 Show Login Message on Connect:   
 Use Name: \_\_\_\_\_  
 Old Password: \_\_\_\_\_  
 New Password: \_\_\_\_\_  
 Confirm New Password: \_\_\_\_\_  
 Timeout Port: 23

**UDP Settings**  
 Enable UDP Access:   
 UDP Port: 50007  
 Remote UDP IP Address: 10.5.64.70  
 Remote UDP Port: 50008

**Web Login Settings**  
 Username: Operator  
 Old Password: \_\_\_\_\_  
 New Password: \_\_\_\_\_  
 Confirm New Password: \_\_\_\_\_

**UDP Settings**

Enable UDP Access

UDP Port

Remote UDP IP Address

Remote UDP Port

**Enable UDP Access**

Click to place a check mark in the check box to enable UDP access. Click to clear the check box and disable UDP access.

**UDP Port**

Enter the UDP listening port in this field.

**Remote UDP IP Address**

Enter the remote UDP IP address in this field.

**Remote UDP Port**

Enter the remote UDP listening port in this field.

**Gefen 4x1 Multiview Seamless Switcher EXT-HD-MVSL-441**

Main | **Web Setup** | Wireless Setup | Presets | EDIO | Network | System | Power (12.620V) | 0.7.2008 | Log Out

IP Settings  
 Web Address: 00:1c:03:3a:10  
 Mode: DHCP  
 IP Address: 192.168.1.199  
 Subnet: 255.255.255.0  
 Gateway: 192.168.1.1  
 HTTP Port: 80

TCP/Telnet Settings  
 Enable TCP Access:   
 Require Password on Connect:   
 Show Login Message on Connect:   
 Use Name:   
 Old Password:   
 New Password:   
 Confirm New Password:   
 Timeout Port: 23

UDP Settings  
 Enable UDP Access:   
 UDP Port: 50007  
 Remote UDP IP Address: 192.168.1.20  
 Remote UDP Port: 50008

Web Login Settings  
 Username: Operator  
 Old Password:   
 New Password:   
 Confirm New Password:

[Set Network Defaults](#) [Save](#)

### Web Login Settings

Username:

Old Password:

New Password:

Confirm New Password:

[Set Network Defaults](#) [Save](#)

#### Username

Click this drop-down list to select the user name.

#### Old Password

Type the old (current) password in this field.

#### New Password

Type the new password in this field.

#### Confirm Password

Re-type the new password in this field.

#### Set Network Defaults

Click to reset the network settings to factory-default.

#### Save

Click this button to save any network changes made on this page.

## System

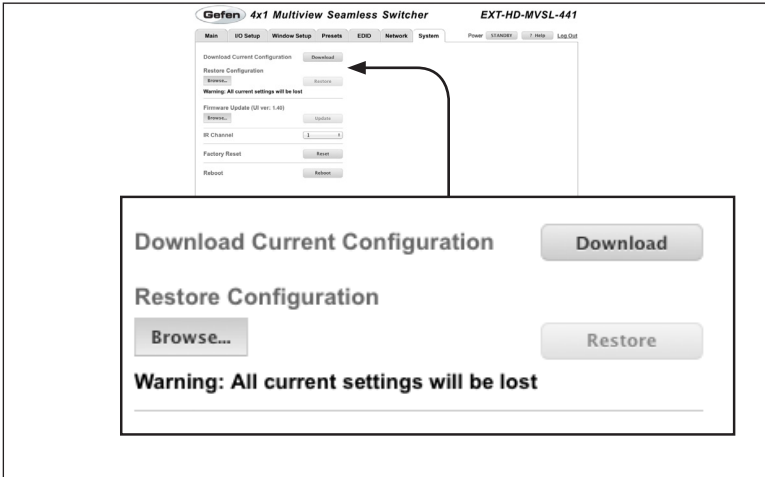

### Download

Click this button to download the current settings and configuration to a file.

### Browse...

Click this button to select the desired configuration file to upload to the switcher. Any current settings will be overwritten when uploading a configuration file.

### Restore

Click this button to upload the selected configuration file to the switcher.

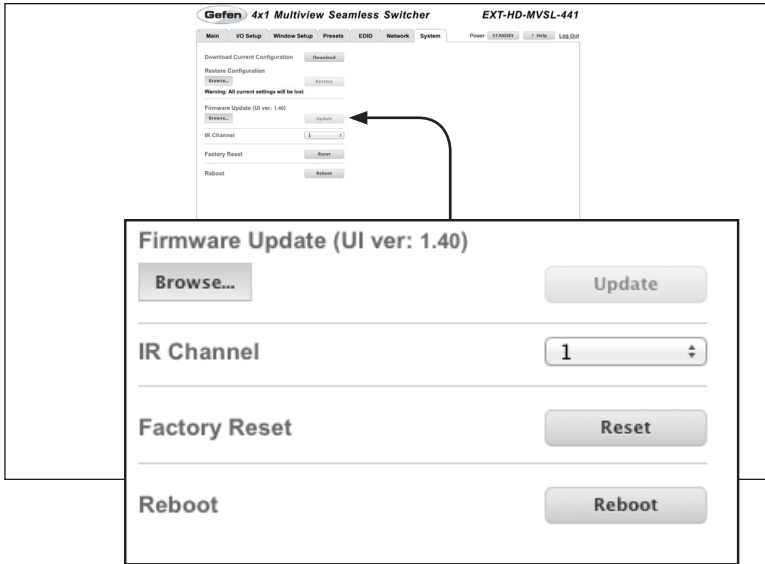
**Browse...**

Click this button to select the firmware file to be uploaded. See [Upgrading the Firmware](#) for details on updating the firmware.

**Update**

Click this button to begin the update process, once the firmware file is selected.

**IR Channel**

Click this drop-down list to select the desired IR channel for the switcher. The default IR channel of the 4x1 Multiview Seamless Switcher for HDMI is channel 0. In order to function correctly, the included IR remote control must also be set to the same channel. See [Setting the IR Channel](#) for more information.

**Reset**

Click this button to set the switcher to factory-default settings. The TCP/IP settings are preserved.

**Reboot**

Click this button to reboot the switcher.







# Multiview

Seamless  
Switcher

## 04 Appendix

Upgrading the Firmware.....	186
Specifications .....	187

# Upgrading the Firmware



**IMPORTANT:** *DO NOT* power-off or disconnect the AC power cord from the switcher, at any time, during the firmware upgrade process.

1. Download the firmware update from the Support section of the Gefen Web site.
2. Extract the firmware file from the .ZIP file.
3. Power-ON the 4x1 Multiview Seamless Switcher for HDMI.

Connect an Ethernet cable between the matrix and the computer running the Web interface.

It is unnecessary to disconnect any cables or extenders from the 4x1 Multiview Seamless Switcher for HDMI during the upgrade process.

4. Click the **System** tab in the Web interface and click the **Browse...** button under the **Firmware Update** section.
5. Select the firmware file and click the **Update** button.
6. The switcher will display a prompt to verify that the current firmware will be overwritten. Click the **OK** button on the dialog box to begin uploading the firmware file.
7. The 4x1 Multiview Seamless Switcher for HDMI will begin the upgrade process. This process will take several minutes. The upgrade process may be monitored using the RS-232 interface.
8. After the 4x1 Multiview Seamless Switcher for HDMI has been updated, the unit will automatically reboot.
9. The firmware upgrade process is complete.

# Specifications

## Supported Formats

Resolutions (max.)	<ul style="list-style-type: none"> <li>• 1080p Full HD</li> <li>• 1920 x 1200 (WUXGA)</li> </ul>
--------------------	--

## Electrical

Maximum Pixel Clock	• 225 MHz
Preset Select Buttons	• 10 x Tact-type, blue backlight
Window Select Buttons	• 4 x Tact-type, blue backlight
Menu Button	• 1 x Tact-type, blue backlight
Menu Control Buttons	• 6 x Tact-type, blue backlight
On / Standby Button	• 1 x Tact-type, blue backlight
Standby Indicator	• 1 x LED, red
Input Indicators	• 20 x LED, blue

## Connectors

Video Input	• 4 x HDMI Type A 19-pin, female, locking
Video Output	• 1 x HDMI Type A 19-pin, female, locking
RS-232	• 1 x DB-9, female
IP Control	• 1 x RJ-45
USB	• Mini-B
IR Extender	• 1 x 3.5mm mini-stereo
Power	• Locking-type

## Operational

Power Input	• 12V DC
Power Consumption	• 24W (max.)

## Physical

Dimensions (W x H x D)	• 16.9" x 1.7" x 7.9" (430mm x 42mm x 200mm)
Unit Weight	• 5.0 lbs (2.3 kg)



Stretch It, Switch It, Split It.  
Gefen's Got It. ®

20600 Nordhoff St., Chatsworth CA 91311  
1-800-545-6900 818-772-9100 fax: 818-772-9120  
[www.gefen.com](http://www.gefen.com) [support@gefen.com](mailto:support@gefen.com)



This product uses UL or CE listed power supplies.