



HR-30S / HR-30D Series
Professional UHF True Diversity Wireless Microphones

 100% recycled paper
100% papier recyclé

Installation and Operation

Contents

Introduction	3
Receiver Installation and Connections	4
Installation	4
Connections	4
Receiver Controls and Functions	5
HR-30S Front panel	5
HR-30S Rear panel	7
HR-30D Front panel	9
HR-30D Rear panel	11
Transmitter Controls and Functions	13
Handheld Microphone	13
Body-pack Transmitter	15
Transmitter Battery Installation	17
System Setup	19
Receiver Setup	21
Transmitter Setup	21
Optional for PC Control Software	22
U485 USB Connector	23
RWW 1.0 PC Digital Control Software	24
Introduction	24
Key Features	24
Operation Manual	25
Operational Step	27
Specifications	29

Thank you for choosing a RELACART professional wireless microphone system. You have joined thousands of other satisfied customers. Years of professional experience of design and manufacturing ensures our products' quality, performance and reliability.

01 Introduction

- ① 1280 Selectable UHF frequencies and True Diversity reception for interference-resistant operation.
- ② On-board Ethernet interface for monitoring and controlling system parameters with " RWW 1.0" Control Interface software.
- ③ The Handheld Transmitter offers durable, magnesium bodies, soft-touch controls.
- ④ Press the "AFS" (Auto Frequency Selection) button 3S and the receiver will auto-scan and lock on to an open, interference-free frequency.
- ⑤ Press [IR] button to upload automatically the receiver frequency to the transmitter.
- ⑥ PLL (Phase Lock Loop frequency control) design ensures transmission reliability. "Noise Lock" squelch effectively blocks stray RF.
- ⑦ EIA-standard metal 1/2-rack receiver chassis, offering programmable features, with high-visibility LCD display.
- ⑧ Battery life is twice as common, up to 15 hours.
- ⑨ HR series provide incredible audio quality and outstandingly reliable performance for artists, broadcasters and other demanding audio environments.

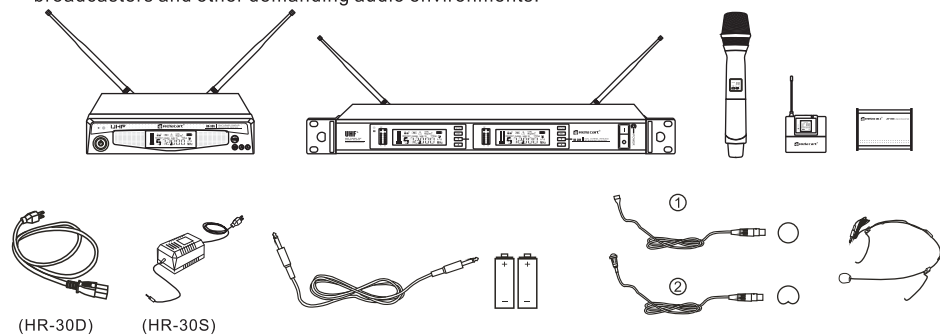

(HR-30D)

(HR-30S)

02 Receiver Installation and Connections

Installation:

- ① For better operation the receiver should be at least 3ft. (1m) above the ground and at least 3ft. away from a wall or metal surface to minimize reflections.
- ② Keep antennas away from noise sources such as computer, digital equipment, motors, automobiles and neon lights, as well as away from large metal objects.
- ③ Attached a pair of UHF antennas to the antenna input jacks, the antenna are normally positioned in the shape of a "V" (both 45° from vertical) for best reception.
- ④ Keep open space between the receiver and transmitter for better reception.
- ⑤ The transmitter should be at least 6ft. (2m) from the receiver.

Connections:

- ① The switching power supply is designed to operate properly from any DC power source 12V, 1A without user adjustment. Simply connect the receiver to a standard DC power outlet, using only an IEC-type input cordset approved for the country use. Power to the unit is controlled by the front panel power switch.
- ② There are two audio outputs on the rear panel: an XLR balanced microphone output and a 1/4" (6.3mm) unbalanced phone jack instrument output. The two isolated audio outputs permit simultaneous feeds to two different inputs. Use the appropriate shielded audio cable for connections between the receiver and the input(s) of the mixer or other equipment.

03 Receiver Controls and Functions

Figure A: HR-30S Receiver Front Panel

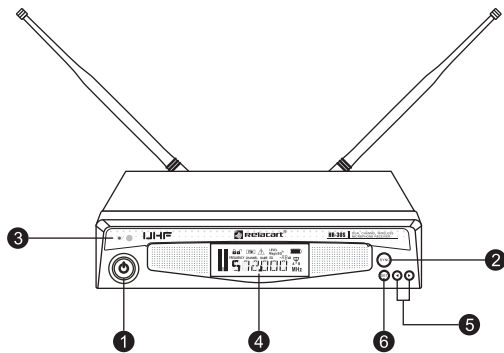

- ① Power Switch: Press power switch in 1 second and the receiver readouts will light, while in 3 seconds the power will be off.
- ② Infrared Data Transfer Button (SYNC): Press this button to transmit frequency and programmed data from receiver to transmitter.
- ③ Infrared Data Transfer Window (iR): Transmit channel and programmed data from the receiver to the transmitter, so that they are in the same frequency and programmed data. Both channel A and channel B can synchronize frequency from receiver to transmitter with this Infrared Window.

④ LCD Window: Liquid Crystal Display indicates control setting and operational readings such as frequency, name, channel, etc. See “System setup” on page 19 for details.

⑤ ◀ / ▶ Buttons:

A, Press Up or Down arrow button, in conjunction with the Set button, to step through menus, select operating frequency and edit receiver function choices.

B, Press Up or Down arrow button 3 seconds and the receiver will auto-scan and lock on to an open, interference-free frequency.

⑥ SET Button: Use in conjunction with the ◀ / ▶ arrow buttons to step through menus, choose operating frequency and select receiver function options.

Figure B: HR-30S Receiver Rear Panel

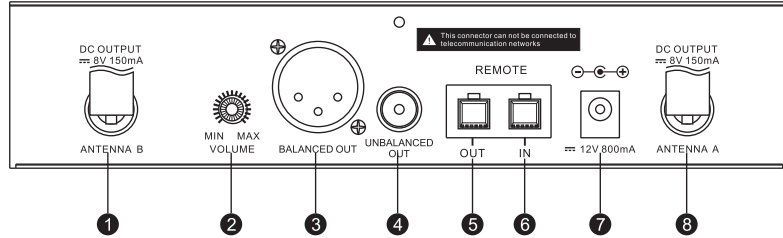

- ①Antenna Input Jack: BNC type antenna connector for tuner " B" , attached the antenna directly.
- ②Volume Button: To adjust the volume.
- ③Balanced Output Jack: XLR type connector. A standard 2 conductor balanced shielded cable can be used to connect the receiver output to a balanced microphone level input connector on a mixer or integrated amplifier.

- ④Unbalanced Mixed Output Jack:1/4" (6.3mm) phone jack can be connected to an aux-level input connector of a mixer, guitar amp or tape recorder with standard unbalanced audio cable.
- ⑤REMOTE-OUT: 4P cable is used to connect with another HR-30S receiver. (IP for each receiver should be different.)
- ⑥REMOTE-IN-U485 Connector: 4P cable is used to connect receiver with computer PC/USB connector to realize software control.
- ⑦DC Power Output Jack: 12V / 800mA.
- ⑧Antenna Input Jack: BNC type antenna connector for tuner "A", attached the antenna directly.

Figure C: HR-30D Receiver Front Panel

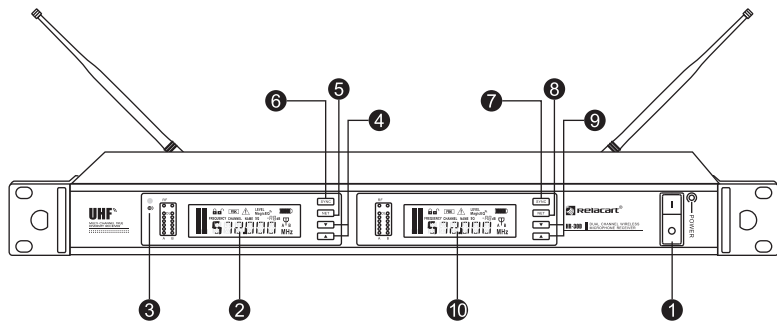

- ① Power Switch: Press power switch in 1 second to turn on the power, and in 3 seconds to turn off the power;
- ② A channel LCD Window: Liquid Crystal Display indicates control setting and operational readings. See “System setup” on page 19 for details.
- ③ Infrared Data Transfer Window (iR): Both for A and B channel. Transmit channel and programmed data from the receiver to the transmitter, so that they are in the same frequency and setup data.
- ④ A Channel ▲ / ▼ Buttons:

- A, Press ▲ / ▼ arrow button, in conjunction with the Set button, to step through menus, select operating frequency and edit receiver function choices.
- B, Press ▲ / ▼ arrow button 3 seconds and the receiver will auto-scan and lock on to an open, interference-free frequency.
- ⑤ A Channel SET Button: Use in conjunction with the ▲ / ▼ arrow buttons to step through menus, choose operating frequency and select receiver function options.
- ⑥ A Channel Infrared Data Transfer Button (SYNC): Press this button to transmit A channel data from receiver to transmitter.
- ⑦ B Channel Infrared Data Transfer Button (SYNC): Press this button to transmit B channel data from receiver to transmitter.
- ⑧ B Channel SET Button: Use in conjunction with the ▲ / ▼ arrow buttons to step through menus, choose operating frequency and select receiver function options.
- ⑨ B Channel ▲ / ▼ Buttons:
- A, Press ▲ / ▼ arrow button, in conjunction with the Set button, to step through menus, select operating frequency and edit receiver function choices.
- B, Press ▲ / ▼ arrow button 3 seconds and the receiver will auto-scan and lock on to an open, interference-free frequency.
- ⑩ B Channel LCD Window: Liquid Crystal Display indicates control setting and operational readings. See “System setup” on page 19 for details.

Figure D: HR-30D Receiver Rear Panel

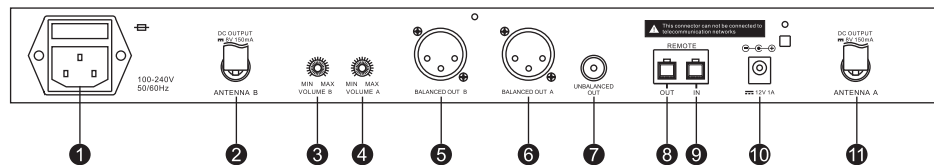

- ① AC Power Input: IEC type connector for 100-240V, 50/60Hz without user adjustment.
- ② Antenna Input Jack: BNC type antenna connector for tuner " B " , attached the antenna directly.
- ③ B Channel Volume Button: To adjust the volume.
- ④ A Channel Volume Button: To adjust the volume.

- ⑤ B Channel Balanced Output Jack: XLR type connector. A standard 2 conductor shielded cable can be used to connect the receiver output to a balanced microphone level input on a mixer or integrated amplifier.
- ⑥ A Channel Balanced Output Jack: XLR type connector. A standard 2 conductor shielded cable can be used to connect the receiver output to a balanced microphone level input on a mixer or integrated amplifier.
- ⑦ Unbalanced Mixed Output Jack: Unbalanced Mixed Output Jack: 1/4" (6.3mm) phone jack for both A and B channel. Can be connected to an aux-level input of a mixer, guitar amp or tape recorder.
- ⑧ REMOTE-OUT: With 4P connecting cables to connect one receiver to another receiver. (Remarks: Each receiver has independent IP.)
- ⑨ REMOTE-IN U485 Connector: With 4P connecting cables to connect HR receivers to PC/USB connector to realize software control.
- ⑩ DC power output jack: 12V/1A.
- ⑪ Antenna Input Jack: BNC type antenna connector for "A" tuner attached the antenna directly.

04 Transmitter Controls and Functions

Handheld Microphone

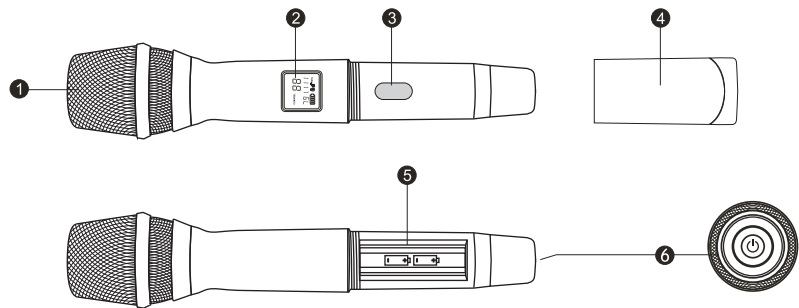

- ① **Microphone Head:** It is the important part to transfer sound into audio signal. The microphone head is separate to change other microphone head if needed.
- ② **LCD Window:** Liquid crystal display indicates operational frequency / channel, mute, lock status, and battery condition. The transmitter's "fuel gauge" battery indicator displays a maximum of 4 bar segments. When it leaves 1 bar segment, the batteries should be replaced immediately to ensure continued operation.

- ③ **Infrared Data Receiving Window (iR):** Use to receive the data signal from the receiver.
- ④ **Battery Cover:** Unscrew it can reveal the battery compartment.
- ⑤ **Battery Compartment:** Insert 2 fresh 1.5V AA batteries. (Alkaline type is recommended. Please remember to replace both batteries.)
Warn: Observe correct polarity as marked inside the battery compartment to avoid damage to the internal electric parts.
- ⑥ **Power Button.**
- A. **Power supply Button:** Press power button in 3 seconds to turn on power and the indicator light turns into green, 3 seconds to turn off the power.
- B. **Mute Button:** Once the microphone power is ON, press this button 1 second, it will be mute, and LCD screen display "MUTE", you will also find the indicator light turns into orange. Press 1 second more to eliminate "Mute" function, letter "MUTE" disappear on the LCD screen, indicator light is back to green.

Body-pack Transmitter

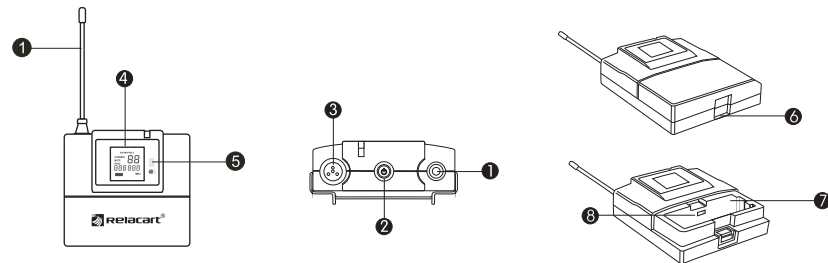

①Antenna

②Power Button

A. Power Supply Button: Press power button in 3 seconds to turn on power and the indicator light turns into green, 3 seconds to turn off the power.

B. Mute Button: Once the bodypack power is ON, press this button 1 second, it will be mute, and LCD screen display "MUTE", you will also find the indicator light turns into orange. Press 1 second more to eliminate "Mute" function, letter "MUTE" disappear on the LCD screen, indicator light is back to green.

③Audio Input Jack: To connect 4-pin mini-XLR connector.

④LCD Window: Liquid crystal display indicates operational frequency / channel, mute, lock status and battery condition. The transmitter's "fuel gauge" battery indicator displays a maximum of 4 bar segments. When it leaves 1 bar segment, the batteries should be replaced immediately to ensure continued operation.

⑤Infrared Data Receiving Window (iR): Use to receive the data signal from the receiver.

⑥Battery Door Switch: Open the battery door by sliding the switch.

⑦Battery Compartment: Insert 2 fresh 1.5 V AA batteries. (Alkaline type is recommended, always replace both batteries.)

Warn: Observe correct polarity as marked inside the battery compartment to avoid damage to the internal electric parts.

⑧ LAV / INS Audio Input Switch: Connect an audio input device (microphone or guitar cable) to the audio input jack on the top of the body-pack transmitter. Choose LAV for microphone input, then INS for guitar cable to connect with guitar or other instruments.

05 Transmitter Battery Installation:

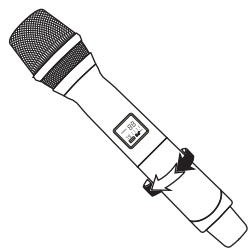

1

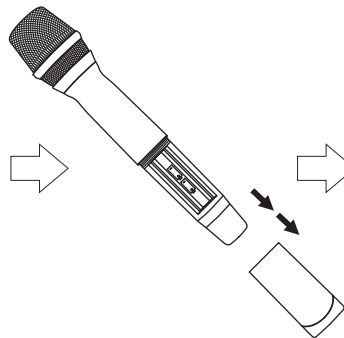

2

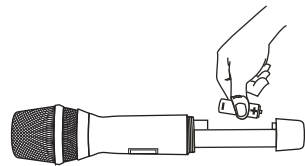

3

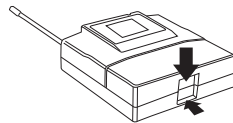

1

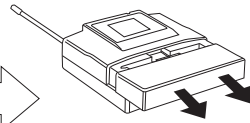

2

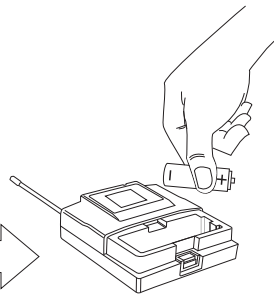

3

Receiver Setup

- ① Turn down the AF level of the associated mixer or amplifier, and make sure that any UR transmitters are turned off before receiver is turned on.
- ② Press power button on receiver, LCD readouts light and will display in normal after 2-3 seconds. If LCD screen shows two different RF signal range, that means there is interference and frequency needs changed.
- ③ To change the frequency by manual or "AFS" (Auto Frequency Scan).
 - a. Change frequency by manual: Press ◀ / ▶ button to change frequency. Selected frequency will be shown on LCD screen after it flashes four times.
 - b. AFS Auto Frequency Scan: Press and hold ◀ / ▶ button 3 seconds and the receiver will auto-scan and lock on to an open, interference-free frequency.
- ④ To enter the menu mode: Press and hold the Set button 3 seconds to enter the edit mode, touch ◀ / ▶ button once to select and set SQUELCH, DISPLAY or LOCK, NAME, MODE, IP, BAT, T-LOCK.

A, SQUELCH: Selecting "SQUELCH", then touch SET Button to enter edit mode, the small data flashes to indicate edit, touch ◀ / ▶ button to scroll through the available choice for the function. The squelch level is adjustable in ten 5dB steps, providing a 50dB range. Press SET Button to confirm the desired choice, then LCD return to its previously displayed contents.
(SQUELCH of receiver has been preset before finishing production. If interference is a problem, first consider trying a different frequency, either manually or scanning. If it is not very necessary, please do not adjust the SQUELCH randomly. This will be bad for the system.)

B, DISPLAY: Selecting "DISPLAY", then touch SET Button to enter edit mode, touch ▶ arrow button, "FREQUENCY" flashes, if stopping on "FREQUENCY", the LCD will display the operational frequency; touch ◀ arrow button, "CHANNEL" flashes, if stopping on "CHANNEL", the LCD will display the operational channel. Press SET Button to confirm the desired choice, then LCD return to its previously displayed contents.

C, R-LOCK: Selecting "R-LOCK", then touch SET Button to enter edit mode, touch ◀ arrow button, it displays "ON", if stopping on "ON", the system enters lock mode, the user can not use any button for any control; touch ▶ arrow button, it displays "OFF", if stopping on "OFF", the user can do any control by any button. Press SET Button to confirm the desired choice, then LCD returns to its previously displayed contents.

- R-LOCK ON: Press "SET" button in 3 seconds, touch ◀ / ▶ arrow button to choose R-LOCK, then press ▶ button, if stopping on "OFF", press "SET" button, system returns to normal setting.
- D. NAME: Selecting "NAME", then touch "SET" Button to enter edit mode(System consented name is HR-30S), when the first number flashes, touch ◀ / ▶ arrow button to choose any number(0-9) or letter(A-Z) or character. After the first number has been picked up, press "SET" button, then the second letter flashes, and repeat the first step operation till the sixth letter is programmed. Touch "SET" button to confirm the desired choice, then LCD returns to its previously displayed contents.
- E. MODE: Selecting "MODE", then touch "SET" Button to enter edit mode, LCD screen displays "CHAN", then press ◀ / ▶ button, it displays "TUNE". If stopping "MODE", it means system can choose 32 preprogrammed channels, press "SET" button and ◀ / ▶ arrow button to choose from 1 to 32 channels; If stopping "TUNE", it means frequency can be programmed by manual, press "SET" and ◀ / ▶ button, The frequency is adjustable in 25KHz. Touch "SET" button to confirm the desired choice, then LCD returns to its previously displayed contents.
- F. IP: Selecting "IP", then touch "SET" button to enter edit mode, LCD screen displays two letters--"IP" address. The letter which flashes can be programmed. Press "SET" or ◀ / ▶ button, IP address of receiver can be set up between 00-99. Touch "SET" button to confirm the desired choice, then LCD returns to previously display contents.
- G. BAT: Selecting "BAT", then touch "SET" button to enter edit mode, LCD screen displays "ALKALI"(alkalinity battery), press ◀ / ▶ arrow button and display "NIMH"(NIMH rechargeable battery), choice is basing on the battery type which the transmitter is using. (Remarks: ALKALI battery is recommended). Touch "SET" button to confirm the desired choice, LCD screen returns to previous display contents. Touch "iR" window synchronizing settings from receiver to transmitter.
- H. T-LOCK: To activate this function, the power switch of transmitter is locked. This is especially designed for live show. Selecting "T-LOCK", then touch "SET" Button to enter edit mode, touch ◀ / ▶ arrow button, it displays "ON", if stopping on "ON", the power switch of transmitter is locked; Touch ▶ arrow button, it displays "OFF", if stopping on "OFF", the user can do any control to transmitter by any button. Press "SET" Button to confirm the desired choice, then LCD return to its previously displayed contents. Touch "iR" window synchronizing settings from receiver to transmitter. Meanwhile, sign for lock status will be display / disappear as the settings (LOCK ON / LOCK OFF sign).

Receiver Setup Diagram:

Function shown:

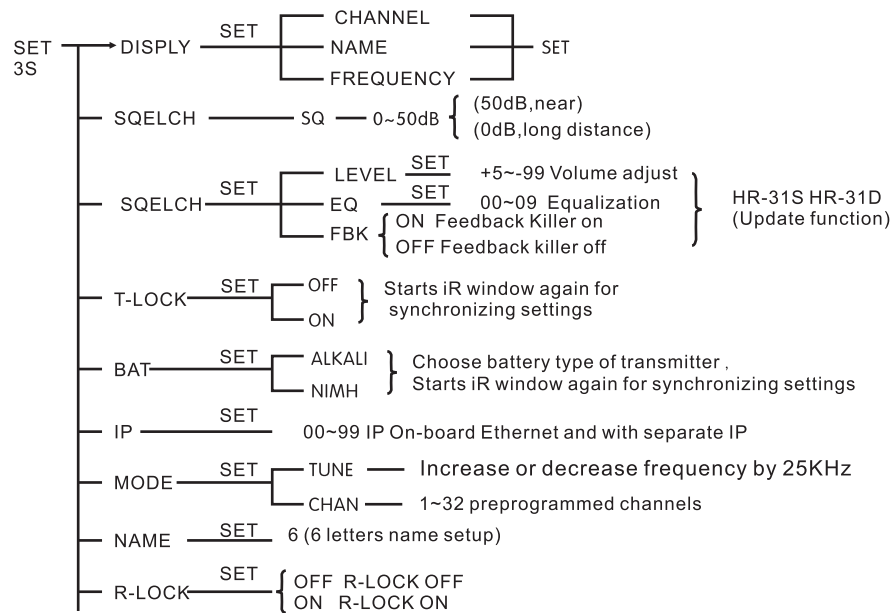

Transmitter Setup

- ① Press and hold power button 3 seconds, the LCD window comes on.
- ② Frequency setup: To let the transmitter IR receiving window face to the receiver IR data transfer window, then press “SYNC” button, the transmitter will receive the frequency / channel data from the receiver, simultaneously the LCD displays the same frequency / channel as the receiver (Figure E).

HR-30S/HR-30D Transmitter frequency setup:

A, Turn on one transmitter, to let the transmitter IR receiving window face to the receiver IR data transfer window, then press A Channel’s “SYNC” button, the transmitter will receive the frequency / channel data from A Channel, simultaneously the LCD displays the same frequency / channel as the receive A Channel.

B, Turn on the other transmitter, to let the transmitter IR receiving window face to the receiver IR data transfer window, then press B Channel’s “SYNC” button, the transmitter will receive the frequency / channel data from B Channel, simultaneously the LCD displays the same frequency / channel as the receive B Channel.

07 U485 USB Connector

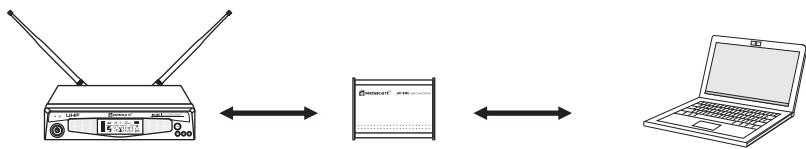

With U485 USB connector, HR-30S receiver and computer can be connected in order to use RWW1.0 digital control software, to realize control and monitor operation through computer software.

Left Side

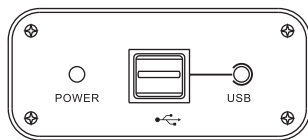

USB Input connector: Connect with computer. If successfully connected, "POWER" indicator light is on. If the computer has not been installed the driver, instruction to the driver installation will be shown on the computer screen. After the driver is installed, USB indicator light is on.

Right Side

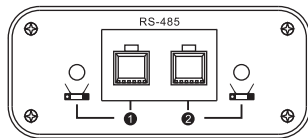

RS-485 Output connector: Connect with HR series receiver, dual-channel output. Each channel can be connected with at most 32 sets wireless systems. If successfully connected, the channel which is connected will light.

08 RWW 1.0 Digital Control Software

1. Instruction

RWW1.0 is an advanced and powerful digital software. The PC controlling using a Relacart U485 connector, to link to HR systems for real time monitored. The controlling software can scans for signal frequencies that could interfere with microphone transmissions and automatically determine the correct frequency for setup, minimizing error and increasing mic-to-mic sound continuity.

Remotely control up to 64 wireless receivers simultaneously from up to 300 meters away. The software can monitor transmitter battery status, AF/RF & Antenna A/B strength.

It has a built-in high performance spectrum analyzer allows direct setup of non-interference frequencies and monitors the wireless environment for all operating channels and interference signals, multi-function and status display are also included for your convenience.

Scans to identify and memorize "dead spots" in the performing area, multi-function and status display are also included for your convenience.

2. Key Features: Auto-scanning, RF signal diagram, Analyze, Control

1) AUTO-SCAN: Frequency Charting Tools

RWW 1.0 software scans RF environments and shows detailed displays of scanned data from Relacart HR series wireless receivers. Through scanning, potential RF problems can be positioned and checked out before they have a chance to affect our sound.

2) RF history plot

This feature can be used to optimize antenna positioning, through the display like signal dropouts where history of signal path is recorded for analysis and real-time program editing. With an interface map can track multiple systems, monitoring a wider range, displays a detailed, easy-understanding graphic representation of RF environment.

3) Analyze: Frequency Analysis and Coordination

After scanning, RWW 1.0 software has ability to count out and analyze which frequency is available and which is not available so that users can choose the clearest frequency in current RF environments. RWW 1.0 software can set up frequencies for single band or compatible models. A list of frequencies can be resulted for compatible solutions to HR wireless systems.

Available Frequency Summary

Printable display of compatible frequencies for a given set of receivers and transmitters



4) Monitor: Complete networked monitoring and control of HR wireless systems
RWW 1.0 software provides fast network setup for large groups of wireless systems, allowing comprehensive control of infrared sync for transmitter setup, and providing different and clear frequencies for choose, offering the immediate informs for important conditions of online channels such as low RF level and low battery strength.

3.RWW 1.0 Software Operation Manual

1).Equipment Connection

- A. USB Connector
- B. HR Wireless Microphone System
- C. Computer Installed with RWW 1.0 control software

2). About USB: U-485 connector

- A.U485 Connector is used to connect with computer software and receiver;
 - B.U485 is set two connection channels, included with 1,2 channel;
 - C. Each connector can connect with 32 units HR series receivers, 2 channels together for 64 receivers;
 - D. U-485 connector can be used as a USB connector.
- 3). Software Operation Function Interface Introduction

A. Control Menu:

ADD HR, CONNECT, DISCONNECT, RF HISTORY PLOT, FREQUENCY PLOT, SINGLE BAND SETUP, COMPATABILITY SET UP.

B. Introduction for Control tools:

①ADD HR:

- 1. Set up ID in RWW 1.0 software for receiver which has been connected;
- 2. More receivers can be added simultaneously.

②CONNECTION: Connect the operation of wireless microphone systems into RWW 1.0 control software;

③DISCONNECTION:

Disconnect the operation of wireless microphone systems into RWW 1.0 control software.

④ RF HISTORY PLOT:

This step is for the Antenna position optimization, test and ensure the stability and reliability of RF. RF history plot presents A.B antennas frequency receive strength (Red and white line shown on software interface). Dead signal plot can be tested out through the RF history Plot in order to adjust the antennas to ensure the reliability of receiving.

⑤ FRQUENCY PLOT:

Frequency of wireless microphone can be auto-scanned and set up through RWW 1.0 software control operation. Through this step, software can auto scan the clearest frequency and auto set up the frequency of receiver.

⑥ SINGLE BAND SET-UP:

This step is for frequency setup for single model. Through RWW 1.0 control software, frequency of wireless microphone can be auto-scanned and we can count out available frequencies in the environment. All the frequencies will be listed for choose and then set up for one system.

⑦COMPATABILITY SET-UP:

- 1. This step is for frequency setup for more than one model.
- 2. Click "Compatibility setup" to get an interface, choose connecting system you want and start scanning;
- 3. After scanning, click "next step" to start counting the frequencies, through this step, RWW 1.0 software can count out which frequencies are available, and which are not.
- 4. Then a list of frequencies which is available for choose has been printed. You can choose any available frequencies separately in this list for the chosen models.

⑧ Frequency Synchronization:

- 1. Double click one of models which is connected you want, there will be a small interface.
- 2. Double click "SYNC" key for frequency synchronization of transmission and receiving.
- 3. Through this interface, locked frequency and channel, transmitter battery status, AF/RF& Antenna A/B strength and frequency can be displayed and monitored.

4.Steps to use RWW 1.0 PC Control Software

1).Equipment Connection

Connect USB: U-485, RWW 1.0 computer software in computer with HR wireless systems receivers. 64 wireless receivers can be simultaneously connected and monitored.

2).Strive USB Connector

3).ID set up in the software

Click “ADD HR” and enter model IP, name, channel (the channel for USB connector: 1 or 2) on the interface to set up ID in the software for the connecting models.

4).Connect/Disconnect.

Click “Connect” or “disconnect” software operation for models. When the models are connected, the models shown on the left side of interface will turn into red color.

5). Frequency Set-up:

Single System---Click “Single Band Setup” ;

Compatible System----Click “Compatibility Band Setup”

Single Band Setup:

Click for Interface—Select connecting equipment--- “Scanning” ---After scanning, click “count” ---
-System auto count out available frequencies---- “Next” ---Select frequencies---Click frequency you want----Finish frequency setup.

Compatibility Bands Setup:

Click for Interface—Select connecting equipment--- “Scanning” ---After scanning, click “count” ----
System auto count out available frequencies---- “Next” ---Select frequencies---Click frequency and equipment you want separately ----Finish frequency setup.

6).Synchronization:

Back to software Interface for left side---Double click to the connected equipment---Synchronization Window--- Put IR signal of transmitter straight forward to IR signal of receiver---Click “Sync” ---Finish Synchronization

7). RF History plot:

Through RF History plot, we can learn the signal strength and reliability whether it is good or not, in order to adjust it to reach a perfect signal.

Notice:

More information about RWW 1.0 control software operation, Please refer to www.relacart.com to download the presentation video, or you can turn to our professional sales for further information. We will be very glad to help. Thank you!

09 Specifications

HR-30S/HR-30D Receiver

Main Frame Size: EIA STANDARD 1/2 U (HR-30S) / EIA STANDARD 1U (HR-30D)
Channels: Single Channel (HR-30S) / Dual Channel (HR-30D)
Frequency Stability: $\pm 0.0005\%$, Phase Lock Loop frequency control
Carrier Frequency Range: UHF 618-936 MHz
Digital Equalizer: Preset Microphone Capsule Modeling
Modulation Mode: FM
Operating Range: 80M typical (in open space)
Oscillation: PLL synthesized
Sensitivity: $5\text{dB}\mu\text{V}$, S/N>60dB at 25 deviation
Band Width: 32MHz
Max. Deviation Range: $\pm 45\text{KHz}$
S/N: >108dB
T.H.D. : <0.6%@ 1KHz
Frequency response: 45Hz~18KHz $\pm 1\text{dB}$
Power Supply: DC 12V / 1A (HR-30S) / 100-240V AC50/60 Hz, 10W(HR-30D)
Weight: 2.0KG (HR-30S); 4.3KG (HR-30D)
Dimension: 210 (W) X 44(H) X 206(D) – HR-30S / 421(W) X 43(H) X 206(D) – HR-30D
Output Connector: XLR balanced & 6.3 ϕ phone jack unbalanced

H-30 Handheld Microphone

Carrier Frequency Range: UHF 618-936 MHz
Oscillation: PLL synthesized
Harmonic radiation: <-63dBm
Bandwidth: 32MHz
Max. Deviation Range: $\pm 45\text{KHz}$
Microphone Element: Cardioid Dynamic / Cardioid Condenser
RF Power Output: 8mW/10mW
Battery: AA X 2
Current Consumption: 90mA, typical
Battery Current / Life: Approximately 15 hours Depending on battery type and use pattern
Dimension: 52(ϕ) X 256 (L)
Weight: 215g

T-30 Body-pack Transmitter

Carrier Frequency Range: UHF 618-936 MHz
Oscillation: PLL synthesized
Harmonic radiation: <-63dBm
Bandwidth: 32MHz
Max. Deviation Range: $\pm 45\text{KHz}$
Input Connector: 4-pin mini-XLR connector
RF Power Output: 15mW
Battery: AA X 1
Current Consumption: 205mA, typical
Battery Current / Life: Approximately 15 hours Depending on battery type and use pattern
Dimension: 71(H) X 63(W) X 20(D)
Weight: 108g